

A GUIDE TO THE
PROJECT MANAGEMENT
BODY OF KNOWLEDGE

PMBOK[®] GUIDE

SIXTH EDITION

INCLUDES: THE STANDARD
FOR PROJECT MANAGEMENT
ANSI/PMI 99-001-2017

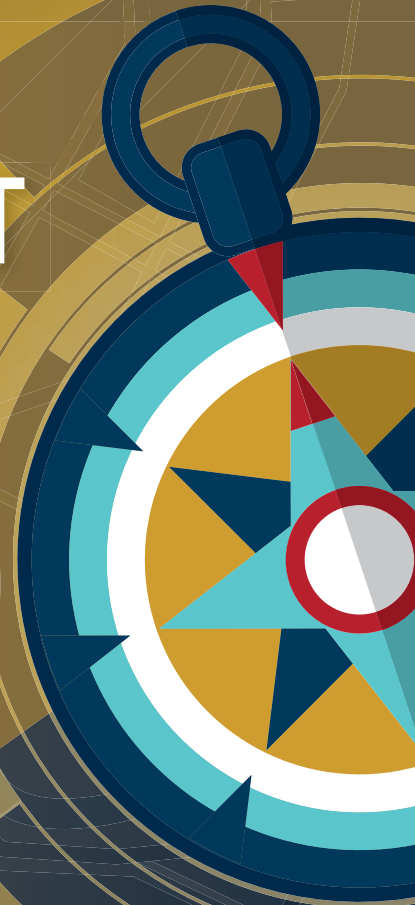

**A Guide to the
PROJECT MANAGEMENT
BODY OF KNOWLEDGE**

(PMBOK® GUIDE)

Sixth Edition

Library of Congress Cataloging-in-Publication Data

Names: Project Management Institute, publisher.

Title: A guide to the project management body of knowledge (PMBOK guide) / Project Management Institute.

Other titles: PMBOK guide

Description: Sixth edition. | Newtown Square, PA: Project Management Institute, 2017. | Series: PMBOK guide | Includes bibliographical references and index.

Identifiers: LCCN 2017032505 (print) | LCCN 2017035597 (ebook) | ISBN 9781628253900 (ePUP) |

ISBN 9781628253917 (Kindle) | ISBN 9781628253924 (Web PDF) | ISBN 9781628251845 (paperback)

Subjects: LCSH: Project management. | BISAC: BUSINESS & ECONOMICS / Project Management.

Classification: LCC HD69.P75 (ebook) | LCC HD69.P75 G845 2017 (print) | DDC 658.4/04--dc23

LC record available at <https://lccn.loc.gov/2017032505>

ISBN: 978-1-62825-184-5

Published by:

Project Management Institute, Inc.

14 Campus Boulevard

Newtown Square, Pennsylvania 19073-3299 USA

Phone: +1 610-356-4600

Fax: +1 610-356-4647

Email: customercare@pmi.org

Website: www.PMI.org

©2017 Project Management Institute, Inc. All rights reserved.

Project Management Institute, Inc. content is copyright protected by U.S. intellectual property law that is recognized by most countries. To republish or reproduce PMI's content, you must obtain our permission. Please go to <http://www.pmi.org/permissions> for details.

To place a Trade Order or for pricing information, please contact Independent Publishers Group:

Independent Publishers Group

Order Department

814 North Franklin Street

Chicago, IL 60610 USA

Phone: +1 800-888-4741

Fax: +1 312- 337-5985

Email: orders@ipgbook.com (For orders only)

For all other inquiries, please contact the PMI Book Service Center.

PMI Book Service Center

P.O. Box 932683, Atlanta, GA 31193-2683 USA

Phone: 1-866-276-4764 (within the U.S. or Canada) or +1-770-280-4129 (globally)

Fax: +1-770-280-4113

Email: info@bookorders.pmi.org

Printed in the United States of America. No part of this work may be reproduced or transmitted in any form or by any means, electronic, manual, photocopying, recording, or by any information storage and retrieval system, without prior written permission of the publisher.

The paper used in this book complies with the Permanent Paper Standard issued by the National Information Standards Organization (Z39.48—1984).

PMI, the PMI logo, PMBOK, OPM3, PMP, CAPM, PgMP, PfMP, PMI-RMP, PMI-SP, PMI-ACP, PMI-PBA, PROJECT MANAGEMENT JOURNAL, PM NETWORK, PMI TODAY, PULSE OF THE PROFESSION and the slogan MAKING PROJECT MANAGEMENT INDISPENSABLE FOR BUSINESS RESULTS. are all marks of Project Management Institute, Inc. For a comprehensive list of PMI trademarks, contact the PMI Legal Department. All other trademarks, service marks, trade names, trade dress, product names and logos appearing herein are the property of their respective owners. Any rights not expressly granted herein are reserved.

10 9 8 7 6 5 4 3 2 1

NOTICE

The Project Management Institute, Inc. (PMI) standards and guideline publications, of which the document contained herein is one, are developed through a voluntary consensus standards development process. This process brings together volunteers and/or seeks out the views of persons who have an interest in the topic covered by this publication. While PMI administers the process and establishes rules to promote fairness in the development of consensus, it does not write the document and it does not independently test, evaluate, or verify the accuracy or completeness of any information or the soundness of any judgments contained in its standards and guideline publications.

PMI disclaims liability for any personal injury, property or other damages of any nature whatsoever, whether special, indirect, consequential or compensatory, directly or indirectly resulting from the publication, use of application, or reliance on this document. PMI disclaims and makes no guaranty or warranty, expressed or implied, as to the accuracy or completeness of any information published herein, and disclaims and makes no warranty that the information in this document will fulfill any of your particular purposes or needs. PMI does not undertake to guarantee the performance of any individual manufacturer or seller's products or services by virtue of this standard or guide.

In publishing and making this document available, PMI is not undertaking to render professional or other services for or on behalf of any person or entity, nor is PMI undertaking to perform any duty owed by any person or entity to someone else. Anyone using this document should rely on his or her own independent judgment or, as appropriate, seek the advice of a competent professional in determining the exercise of reasonable care in any given circumstances. Information and other standards on the topic covered by this publication may be available from other sources, which the user may wish to consult for additional views or information not covered by this publication.

PMI has no power, nor does it undertake to police or enforce compliance with the contents of this document. PMI does not certify, test, or inspect products, designs, or installations for safety or health purposes. Any certification or other statement of compliance with any health or safety-related information in this document shall not be attributable to PMI and is solely the responsibility of the certifier or maker of the statement.

TABLE OF CONTENTS

PART 1.

A GUIDE TO THE PROJECT MANAGEMENT BODY OF KNOWLEDGE (*PMBOK® Guide*)

1. INTRODUCTION	1
1.1 Overview and Purpose of this Guide	1
1.1.1 The Standard for Project Management	2
1.1.2 Common Vocabulary	3
1.1.3 Code of Ethics and Professional Conduct	3
1.2 Foundational Elements	4
1.2.1 Projects	4
1.2.2 The Importance of Project Management	10
1.2.3 Relationship of Project, Program, Portfolio, and Operations Management	11
1.2.4 Components of the Guide	17
1.2.5 Tailoring	28
1.2.6 Project Management Business Documents	29
2. THE ENVIRONMENT IN WHICH PROJECTS OPERATE	37
2.1 Overview	37
2.2 Enterprise Environmental Factors	38
2.2.1 EEFs Internal to the Organization	38
2.2.2 EEFs External to the Organization	39

2.3 Organizational Process Assets	39
2.3.1 Processes, Policies, and Procedures	40
2.3.2 Organizational Knowledge Repositories	41
2.4 Organizational Systems	42
2.4.1 Overview	42
2.4.2 Organizational Governance Frameworks	43
2.4.3 Management Elements	44
2.4.4 Organizational Structure Types	45
3. THE ROLE OF THE PROJECT MANAGER.....	51
3.1 Overview	51
3.2 Definition of a Project Manager	52
3.3 The Project Manager’s Sphere of Influence	52
3.3.1 Overview	52
3.3.2 The Project.....	53
3.3.3 The Organization	54
3.3.4 The Industry	55
3.3.5 Professional Discipline	56
3.3.6 Across Disciplines.....	56
3.4 Project Manager Competences.....	56
3.4.1 Overview	56
3.4.2 Technical Project Management Skills	58
3.4.3 Strategic and Business Management Skills	58
3.4.4 Leadership Skills.....	60
3.4.5 Comparison of Leadership and Management	64
3.5 Performing Integration	66
3.5.1 Performing Integration at the Process Level.....	67
3.5.2 Integration at the Cognitive Level.....	67
3.5.3 Integration at the Context Level	67
3.5.4 Integration and Complexity.....	68

4. PROJECT INTEGRATION MANAGEMENT	69
4.1 Develop Project Charter	75
4.1.1 Develop Project Charter: Inputs.....	77
4.1.2 Develop Project Charter: Tools and Techniques.....	79
4.1.3 Develop Project Charter: Outputs	81
4.2 Develop Project Management Plan.....	82
4.2.1 Develop Project Management Plan: Inputs	83
4.2.2 Develop Project Management Plan: Tools and Techniques	85
4.2.3 Develop Project Management Plan: Outputs.....	86
4.3 Direct and Manage Project Work	90
4.3.1 Direct and Manage Project Work: Inputs	92
4.3.2 Direct and Manage Project Work: Tools and Techniques	94
4.3.3 Direct and Manage Project Work: Outputs.....	95
4.4 Manage Project Knowledge	98
4.4.1 Manage Project Knowledge: Inputs.....	100
4.4.2 Manage Project Knowledge: Tools and Techniques.....	102
4.4.3 Manage Project Knowledge: Outputs	104
4.5 Monitor and Control Project Work	105
4.5.1 Monitor and Control Project Work: Inputs.....	107
4.5.2 Monitor and Control Project Work: Tools and Techniques.....	110
4.5.3 Monitor and Control Project Work: Outputs	112
4.6 Perform Integrated Change Control.....	113
4.6.1 Perform Integrated Change Control: Inputs	116
4.6.2 Perform Integrated Change Control: Tools and Techniques	118
4.6.3 Perform Integrated Change Control: Outputs.....	120
4.7 Close Project or Phase	121
4.7.1 Close Project or Phase: Inputs.....	124
4.7.2 Close Project or Phase: Tools and Techniques.....	126
4.7.3 Close Project or Phase: Outputs	127

5. PROJECT SCOPE MANAGEMENT	129
5.1 Plan Scope Management.....	134
5.1.1 Plan Scope Management: Inputs.....	135
5.1.2 Plan Scope Management: Tools and Techniques.....	136
5.1.3 Plan Scope Management: Outputs	137
5.2 Collect Requirements	138
5.2.1 Collect Requirements: Inputs	140
5.2.2 Collect Requirements: Tools and Techniques	142
5.2.3 Collect Requirements: Outputs	147
5.3 Define Scope.....	150
5.3.1 Define Scope: Inputs	152
5.3.2 Define Scope: Tools and Techniques	153
5.3.3 Define Scope: Outputs.....	154
5.4 Create WBS	156
5.4.1 Create WBS: Inputs	157
5.4.2 Create WBS: Tools and Techniques	158
5.4.3 Create WBS: Outputs.....	161
5.5 Validate Scope	163
5.5.1 Validate Scope: Inputs	165
5.5.2 Validate Scope: Tools and Techniques	166
5.5.3 Validate Scope: Outputs.....	166
5.6 Control Scope	167
5.6.1 Control Scope: Inputs.....	169
5.6.2 Control Scope: Tools and Techniques.....	170
5.6.3 Control Scope: Outputs	170
6. PROJECT SCHEDULE MANAGEMENT.....	173
6.1 Plan Schedule Management	179
6.1.1 Plan Schedule Management: Inputs.....	180
6.1.2 Plan Schedule Management: Tools and Techniques.....	181
6.1.3 Plan Schedule Management: Outputs	181
6.2 Define Activities.....	183
6.2.1 Define Activities: Inputs.....	184

6.2.2 Define Activities: Tools and Techniques	184
6.2.3 Define Activities: Outputs	185
6.3 Sequence Activities	187
6.3.1 Sequence Activities: Inputs	188
6.3.2 Sequence Activities: Tools and Techniques	189
6.3.3 Sequence Activities: Outputs.....	194
6.4 Estimate Activity Durations.....	195
6.4.1 Estimate Activity Durations: Inputs.....	198
6.4.2 Estimate Activity Durations: Tools and Techniques	200
6.4.3 Estimate Activity Durations: Outputs	203
6.5 Develop Schedule	205
6.5.1 Develop Schedule: Inputs	207
6.5.2 Develop Schedule: Tools and Techniques	209
6.5.3 Develop Schedule: Outputs.....	217
6.6 Control Schedule	222
6.6.1 Control Schedule: Inputs.....	224
6.6.2 Control Schedule: Tools and Techniques.....	226
6.6.3 Control Schedule: Outputs	228
7. PROJECT COST MANAGEMENT	231
7.1 Plan Cost Management	235
7.1.1 Plan Cost Management: Inputs.....	236
7.1.2 Plan Cost Management: Tools and Techniques.....	237
7.1.3 Plan Cost Management: Outputs	238
7.2 Estimate Costs.....	240
7.2.1 Estimate Costs: Inputs	241
7.2.2 Estimate Costs: Tools and Techniques	243
7.2.3 Estimate Costs: Outputs.....	246
7.3 Determine Budget.....	248
7.3.1 Determine Budget: Inputs	250
7.3.2 Determine Budget: Tools and Techniques	252
7.3.3 Determine Budget: Outputs.....	254

7.4 Control Costs	257
7.4.1 Control Costs: Inputs.....	259
7.4.2 Control Costs: Tools and Techniques.....	260
7.4.3 Control Costs: Outputs	268
8. PROJECT QUALITY MANAGEMENT	271
8.1 Plan Quality Management	277
8.1.1 Plan Quality Management: Inputs	279
8.1.2 Plan Quality Management: Tools and Techniques	281
8.1.3 Plan Quality Management: Outputs	286
8.2 Manage Quality	288
8.2.1 Manage Quality: Inputs	290
8.2.2 Manage Quality: Tools and Techniques	292
8.2.3 Manage Quality: Outputs.....	296
8.3 Control Quality	298
8.3.1 Control Quality: Inputs	300
8.3.2 Control Quality: Tools and Techniques	302
8.3.3 Control Quality: Outputs.....	305
9. PROJECT RESOURCE MANAGEMENT	307
9.1 Plan Resource Management	312
9.1.1 Plan Resource Management: Inputs.....	314
9.1.2 Plan Resource Management: Tools and Techniques.....	315
9.1.3 Plan Resource Management: Outputs	318
9.2 Estimate Activity Resources	320
9.2.1 Estimate Activity Resources: Inputs.....	322
9.2.2 Estimate Activity Resources: Tools and Techniques.....	324
9.2.3 Estimate Activity Resources: Outputs	325
9.3 Acquire Resources	328
9.3.1 Acquire Resources: Inputs.....	330
9.3.2 Acquire Resources: Tools and Techniques.....	332
9.3.3 Acquire Resources: Outputs	333

9.4 Develop Team.....	336
9.4.1 Develop Team: Inputs.....	339
9.4.2 Develop Team: Tools and Techniques.....	340
9.4.3 Develop Team: Outputs	343
9.5 Manage Team.....	345
9.5.1 Manage Team: Inputs.....	347
9.5.2 Manage Team: Tools and Techniques.....	348
9.5.3 Manage Team: Outputs	350
9.6 Control Resources	352
9.6.1 Control Resources: Inputs.....	354
9.6.2 Control Resources: Tools and Techniques.....	356
9.6.3 Control Resources: Outputs	357
10. PROJECT COMMUNICATIONS MANAGEMENT	359
10.1 Plan Communications Management.....	366
10.1.1 Plan Communications Management: Inputs	368
10.1.2 Plan Communications Management: Tools and Techniques	369
10.1.3 Plan Communications Management: Outputs.....	377
10.2 Manage Communications	379
10.2.1 Manage Communications: Inputs.....	381
10.2.2 Manage Communications: Tools and Techniques.....	383
10.2.3 Manage Communications: Outputs	387
10.3 Monitor Communications.....	388
10.3.1 Monitor Communications: Inputs	390
10.3.2 Monitor Communications: Tools and Techniques	391
10.3.3 Monitor Communications: Outputs.....	392
11. PROJECT RISK MANAGEMENT	395
11.1 Plan Risk Management	401
11.1.1 Plan Risk Management: Inputs.....	402
11.1.2 Plan Risk Management: Tools and Techniques.....	404
11.1.3 Plan Risk Management: Outputs	405

11.2 Identify Risks	409
11.2.1 Identify Risks: Inputs	411
11.2.2 Identify Risks: Tools and Techniques	414
11.2.3 Identify Risks: Outputs	417
11.3 Perform Qualitative Risk Analysis	419
11.3.1 Perform Qualitative Risk Analysis: Inputs	421
11.3.2 Perform Qualitative Risk Analysis: Tools and Techniques	422
11.3.3 Perform Qualitative Risk Analysis: Outputs	427
11.4 Perform Quantitative Risk Analysis	428
11.4.1 Perform Quantitative Risk Analysis: Inputs	430
11.4.2 Perform Quantitative Risk Analysis: Tools and Techniques	431
11.4.3 Perform Quantitative Risk Analysis: Outputs	436
11.5 Plan Risk Responses	437
11.5.1 Plan Risk Responses: Inputs	439
11.5.2 Plan Risk Responses: Tools and Techniques	441
11.5.3 Plan Risk Responses: Outputs	447
11.6 Implement Risk Responses	449
11.6.1 Implement Risk Responses: Inputs	450
11.6.2 Implement Risk Responses: Tools and Techniques	451
11.6.3 Implement Risk Responses: Outputs	451
11.7 Monitor Risks	453
11.7.1 Monitor Risks: Inputs	455
11.7.2 Monitor Risks: Tools and Techniques	456
11.7.3 Monitor Risks: Outputs	457
12. PROJECT PROCUREMENT MANAGEMENT	459
12.1 Plan Procurement Management	466
12.1.1 Plan Procurement Management: Inputs	468
12.1.2 Plan Procurement Management: Tools and Techniques	472
12.1.3 Plan Procurement Management: Outputs	475

12.2 Conduct Procurements.....	482
12.2.1 Conduct Procurements: Inputs.....	484
12.2.2 Conduct Procurements: Tools and Techniques.....	487
12.2.3 Conduct Procurements: Outputs.....	488
12.3 Control Procurements.....	492
12.3.1 Control Procurements: Inputs.....	495
12.3.2 Control Procurements: Tools and Techniques.....	497
12.3.3 Control Procurements: Outputs.....	499
13. PROJECT STAKEHOLDER MANAGEMENT.....	503
13.1 Identify Stakeholders.....	507
13.1.1 Identify Stakeholders: Inputs.....	509
13.1.2 Identify Stakeholders: Tools and Techniques.....	511
13.1.3 Identify Stakeholders: Outputs.....	514
13.2 Plan Stakeholder Engagement.....	516
13.2.1 Plan Stakeholder Engagement: Inputs.....	518
13.2.2 Plan Stakeholder Engagement: Tools and Techniques.....	520
13.2.3 Plan Stakeholder Engagement: Outputs.....	522
13.3 Manage Stakeholder Engagement.....	523
13.3.1 Manage Stakeholder Engagement: Inputs.....	525
13.3.2 Manage Stakeholder Engagement: Tools and Techniques.....	526
13.3.3 Manage Stakeholder Engagement: Outputs.....	528
13.4 Monitor Stakeholder Engagement.....	530
13.4.1 Monitor Stakeholder Engagement: Inputs.....	532
13.4.2 Monitor Stakeholder Engagement: Tools and Techniques.....	533
13.4.3 Monitor Stakeholder Engagement: Outputs.....	535
REFERENCES.....	537

**PART 2.
THE STANDARD FOR PROJECT MANAGEMENT**

1. INTRODUCTION	541
1.1 Projects and Project Management	542
1.2 Relationships Among Portfolios, Programs, and Projects	543
1.3 Linking Organizational Governance and Project Governance	545
1.4 Project Success and Benefits Management	546
1.5 The Project Life Cycle	547
1.6 Project Stakeholders	550
1.7 Role of the Project Manager	552
1.8 Project Management Knowledge Areas	553
1.9 Project Management Process Groups	554
1.10 Enterprise Environmental Factors and Organizational Process Assets	557
1.11 Tailoring the Project Artifacts	558
2. INITIATING PROCESS GROUP	561
2.1 Develop Project Charter	563
2.2 Identify Stakeholders	563
2.2.1 Project Management Plan Components	564
2.2.2 Project Documents Examples	564
2.2.3 Project Management Plan Updates	564
2.2.4 Project Documents Updates	564
3. PLANNING PROCESS GROUP	565
3.1 Develop Project Management Plan	567
3.2 Plan Scope Management	567
3.2.1 Project Management Plan Components	568
3.3 Collect Requirements	568
3.3.1 Project Management Plan Components	568
3.3.2 Project Documents Examples	569

3.4 Define Scope	569
3.4.1 Project Management Plan Components	569
3.4.2 Project Documents Examples	569
3.4.3 Project Documents Updates	570
3.5 Create WBS	570
3.5.1 Project Management Plan Components	570
3.5.2 Project Documents Examples	571
3.5.3 Project Documents Updates	571
3.6 Plan Schedule Management	571
3.6.1 Project Management Plan Components	572
3.7 Define Activities	572
3.7.1 Project Management Plan Components	572
3.7.2 Project Management Plan Updates	572
3.8 Sequence Activities	573
3.8.1 Project Management Plan Components	573
3.8.2 Project Documents Examples	573
3.8.3 Project Documents Updates	573
3.9 Estimate Activity Durations	574
3.9.1 Project Management Plan Components	574
3.9.2 Project Documents Examples	574
3.9.3 Project Documents Updates	575
3.10 Develop Schedule	575
3.10.1 Project Management Plan Components	575
3.10.2 Project Documents Examples	576
3.10.3 Project Management Plan Updates	576
3.10.4 Project Documents Updates	576
3.11 Plan Cost Management	577
3.11.1 Project Management Plan Components	577

3.12 Estimate Costs	577
3.12.1 Project Management Plan Components	578
3.12.2 Project Documents Examples	578
3.12.3 Project Documents Updates	578
3.13 Determine Budget.....	578
3.13.1 Project Management Plan Components	579
3.13.2 Project Documents Examples	579
3.13.3 Project Documents Updates	579
3.14 Plan Quality Management	580
3.14.1 Project Management Plan Components	580
3.14.2 Project Documents Examples	580
3.14.3 Project Management Plan Updates	581
3.14.4 Project Documents Updates	581
3.15 Plan Resource Management	581
3.15.1 Project Management Plan Components	582
3.15.2 Project Documents	582
3.15.3 Project Documents Updates	582
3.16 Estimate Activity Resources	582
3.16.1 Project Management Plan Components	583
3.16.2 Project Documents Examples	583
3.16.3 Project Documents Updates	583
3.17 Plan Communications Management.....	584
3.17.1 Project Management Plan Components	584
3.17.2 Project Documents Examples	584
3.17.3 Project Management Plan Updates	584
3.17.4 Project Documents Updates	585
3.18 Plan Risk Management	585
3.18.1 Project Management Plan Components	585
3.18.2 Project Documents Examples	585

3.19 Identify Risks	586
3.19.1 Project Management Plan Components	586
3.19.2 Project Documents Examples	587
3.19.3 Project Documents Updates	587
3.20 Perform Qualitative Risk Analysis	588
3.20.1 Project Management Plan Components	588
3.20.2 Project Documents Examples	588
3.20.3 Project Documents Updates	589
3.21 Perform Quantitative Risk Analysis	589
3.21.1 Project Management Plan Components	589
3.21.2 Project Documents Examples	590
3.21.3 Project Documents Updates	590
3.22 Plan Risk Responses	590
3.22.1 Project Management Plan Components	591
3.22.2 Project Documents Examples	591
3.22.3 Project Management Plan Updates	591
3.22.4 Project Documents Updates	592
3.23 Plan Procurement Management	592
3.23.1 Project Management Plan Components	593
3.23.2 Project Documents Examples	593
3.23.3 Project Documents Updates	593
3.24 Plan Stakeholder Engagement	594
3.24.1 Project Management Plan Components	594
3.24.2 Project Documents Examples	594
4. EXECUTING PROCESS GROUP	595
4.1 Direct and Manage Project Work	597
4.1.1 Project Management Plan Components	597
4.1.2 Project Documents Examples	597
4.1.3 Project Management Plan Updates	598
4.1.4 Project Documents Updates	598

4.2 Manage Project Knowledge	598
4.2.1 Project Management Plan Components	599
4.2.2 Project Documents	599
4.2.3 Project Management Plan Updates	599
4.3 Manage Quality	599
4.3.1 Project Management Plan Components	600
4.3.2 Project Documents Examples	600
4.3.3 Project Management Plan Updates	600
4.3.4 Project Documents Updates	600
4.4 Acquire Resources	601
4.4.1 Project Management Plan Components	601
4.4.2 Project Documents Examples	601
4.4.3 Project Management Plan Updates	602
4.4.4 Project Documents Updates	602
4.5 Develop Team.....	602
4.5.1 Project Management Plan Components	603
4.5.2 Project Documents Examples	603
4.5.3 Project Management Plan Updates	603
4.5.4 Project Documents Updates	603
4.6 Manage Team.....	604
4.6.1 Project Management Plan Components	604
4.6.2 Project Documents Examples	604
4.6.3 Project Management Plan Updates	605
4.6.4 Project Documents Updates	605
4.7 Manage Communications	605
4.7.1 Project Management Plan Components	606
4.7.2 Project Documents Example.....	606
4.7.3 Project Management Plan Updates	606
4.7.4 Project Documents Updates	606

4.8 Implement Risk Responses.....	607
4.8.1 Project Management Plan Components	607
4.8.2 Project Documents Examples	607
4.8.3 Project Documents Updates	607
4.9 Conduct Procurements.....	608
4.9.1 Project Management Plan Components	608
4.9.2 Project Documents Examples	609
4.9.3 Project Management Plan Updates	609
4.9.4 Project Documents Updates	609
4.10 Manage Stakeholder Engagement.....	610
4.10.1 Project Management Plan Components	610
4.10.2 Project Documents Examples	610
4.10.3 Project Management Plan Updates	611
4.10.4 Project Documents Updates	611
5. MONITORING AND CONTROLLING PROCESS GROUP	613
5.1 Monitor and Control Project Work	615
5.1.1 Project Management Plan Components	615
5.1.2 Project Documents Examples	615
5.1.3 Project Management Plan Updates	616
5.1.4 Project Documents Updates	616
5.2 Perform Integrated Change Control	616
5.2.1 Project Management Plan Components	617
5.2.2 Project Documents Examples	617
5.2.3 Project Management Plan Updates	617
5.2.4 Project Documents Updates	617
5.3 Validate Scope	618
5.3.1 Project Management Plan Components	618
5.3.2 Project Documents Examples	618
5.3.3 Project Documents Updates	619

5.4 Control Scope	619
5.4.1 Project Management Plan Components	619
5.4.2 Project Documents Examples	620
5.4.3 Project Management Plan Updates	620
5.4.4 Project Documents Updates	620
5.5 Control Schedule	621
5.5.1 Project Management Plan Components	621
5.5.2 Project Documents Examples	621
5.5.3 Project Management Plan Updates	622
5.5.4 Project Documents Updates	622
5.6 Control Costs	622
5.6.1 Project Management Plan Components	623
5.6.2 Project Documents Examples	623
5.6.3 Project Management Plan Updates	623
5.6.4 Project Documents Updates	623
5.7 Control Quality	624
5.7.1 Project Management Plan Components	624
5.7.2 Project Documents Examples	624
5.7.3 Project Management Plan Updates	625
5.7.4 Project Documents Updates	625
5.8 Control Resources	625
5.8.1 Project Management Plan Components	626
5.8.2 Project Documents Examples	626
5.8.3 Project Management Plan Updates	626
5.8.4 Project Documents Updates	626
5.9 Monitor Communications	627
5.9.1 Project Management Plan Components	627
5.9.2 Project Documents Examples	627
5.9.3 Project Management Plan Updates	628
5.9.4 Project Documents Updates	628

5.10 Monitor Risks.....	628
5.10.1 Project Management Plan Components	629
5.10.2 Project Documents Examples	629
5.10.3 Project Management Plan Updates	629
5.10.4 Project Documents Updates	629
5.11 Control Procurements	629
5.11.1 Project Management Plan Components	630
5.11.2 Project Documents Examples	630
5.11.3 Project Management Plan Updates	631
5.11.4 Project Documents Updates	631
5.12 Monitor Stakeholder Engagement	631
5.12.1 Project Management Plan Components	632
5.12.2 Project Documents Examples	632
5.12.3 Project Management Plan Updates	632
5.12.4 Project Documents Updates	632
6. CLOSING PROCESS GROUP	633
6.1 Close Project or Phase	634
6.1.1 Project Management Plan Components	634
6.1.2 Project Documents Examples	635
6.1.3 Project Documents Updates	635

**PART 3.
APPENDICES, GLOSSARY, AND INDEX**

APPENDIX X1 SIXTH EDITION CHANGES.....	639
APPENDIX X2 CONTRIBUTORS AND REVIEWERS OF THE <i>PMBOK® GUIDE</i>—SIXTH EDITION.....	651
APPENDIX X3 AGILE, ITERATIVE, ADAPTIVE, AND HYBRID PROJECT ENVIRONMENTS	665
APPENDIX X4 SUMMARY OF KEY CONCEPTS FOR KNOWLEDGE AREAS.....	673
APPENDIX X5 SUMMARY OF TAILORING CONSIDERATIONS FOR KNOWLEDGE AREAS	679
APPENDIX X6 TOOLS AND TECHNIQUES	685
GLOSSARY	695

LIST OF TABLES AND FIGURES

PART 1.

A GUIDE TO THE PROJECT MANAGEMENT BODY OF KNOWLEDGE (*PMBOK® Guide*)

Figure 1-1.	Organizational State Transition via a Project	6
Figure 1-2.	Project Initiation Context.....	8
Figure 1-3.	Portfolio, Programs, Projects, and Operations.....	12
Figure 1-4.	Organizational Project Management	17
Figure 1-5.	Interrelationship of <i>PMBOK® Guide</i> Key Components in Projects	18
Figure 1-6.	Example Process: Inputs, Tools & Techniques, and Outputs.....	22
Figure 1-7.	Project Data, Information, and Report Flow	27
Figure 1-8.	Interrelationship of Needs Assessment and Critical Business/ Project Documents	30
Figure 2-1.	Project Influences.....	37
Figure 3-1.	Example of Project Manager’s Sphere of Influence	53
Figure 3-2.	The PMI Talent Triangle®	57
Figure 4-1.	Project Integration Management Overview	71
Figure 4-2.	Develop Project Charter: Inputs, Tools & Techniques, and Outputs.....	75
Figure 4-3.	Develop Project Charter: Data Flow Diagram	76
Figure 4-4.	Develop Project Management Plan: Inputs, Tools & Techniques, and Outputs.....	82

Figure 4-5.	Develop Project Management Plan: Data Flow Diagram	82
Figure 4-6.	Direct and Manage Project Work: Inputs, Tools & Techniques, and Outputs.....	90
Figure 4-7.	Direct and Manage Project Work: Data Flow Diagram.....	91
Figure 4-8.	Manage Project Knowledge: Inputs, Tools & Techniques, and Outputs.....	98
Figure 4-9.	Manage Project Knowledge: Data Flow Diagram	99
Figure 4-10.	Monitor and Control Project Work: Inputs, Tools & Techniques, and Outputs.....	105
Figure 4-11.	Monitor and Control Project Work: Data Flow Diagram	106
Figure 4-12.	Perform Integrated Change Control: Inputs, Tools & Techniques, and Outputs.....	113
Figure 4-13.	Perform Integrated Change Control: Data Flow Diagram	114
Figure 4-14.	Close Project or Phase: Inputs, Tools & Techniques, and Outputs.....	121
Figure 4-15.	Close Project or Phase: Data Flow Diagram	122
Figure 5-1.	Project Scope Management Overview	130
Figure 5-2.	Plan Scope Management: Inputs, Tools & Techniques, and Outputs.....	134
Figure 5-3.	Plan Scope Management: Data Flow Diagram	134
Figure 5-4.	Collect Requirements: Inputs, Tools & Techniques, and Outputs	138
Figure 5-5.	Collect Requirements: Data Flow Diagram.....	139
Figure 5-6.	Context Diagram	146
Figure 5-7.	Example of a Requirements Traceability Matrix	149
Figure 5-8.	Define Scope: Inputs, Tools & Techniques, and Outputs	150
Figure 5-9.	Define Scope: Data Flow Diagram	151
Figure 5-10.	Create WBS: Inputs, Tools & Techniques, and Outputs	156
Figure 5-11.	Create WBS: Data Flow Diagram.....	156
Figure 5-12.	Sample WBS Decomposed Down Through Work Packages.....	158
Figure 5-13.	Sample WBS Organized by Phase.....	159

Figure 5-14.	Sample WBS with Major Deliverables.....	160
Figure 5-15.	Validate Scope: Inputs, Tools & Techniques, and Outputs	163
Figure 5-16.	Validate Scope: Data Flow Diagram.....	164
Figure 5-17.	Control Scope: Inputs, Tools & Techniques, and Outputs.....	167
Figure 5-18.	Control Scope: Data Flow Diagram	168
Figure 6-1.	Project Schedule Management Overview	174
Figure 6-2.	Scheduling Overview	176
Figure 6-3.	Plan Schedule Management: Inputs, Tools & Techniques, and Outputs.....	179
Figure 6-4.	Plan Schedule Management: Data Flow Diagram	179
Figure 6-5.	Define Activities: Inputs, Tools & Techniques, and Outputs.....	183
Figure 6-6.	Define Activities: Data Flow Diagram	183
Figure 6-7.	Sequence Activities: Inputs, Tools & Techniques, and Outputs	187
Figure 6-8.	Sequence Activities: Data Flow Diagram.....	187
Figure 6-9.	Precedence Diagramming Method (PDM) Relationship Types	190
Figure 6-10.	Examples of Lead and Lag	192
Figure 6-11.	Project Schedule Network Diagram.....	193
Figure 6-12.	Estimate Activity Durations: Inputs, Tools & Techniques, and Outputs.....	195
Figure 6-13.	Estimate Activity Durations: Data Flow Diagram	196
Figure 6-14.	Develop Schedule: Inputs, Tools & Techniques, and Outputs	205
Figure 6-15.	Develop Schedule: Data Flow Diagram.....	206
Figure 6-16.	Example of Critical Path Method.....	211
Figure 6-17.	Resource Leveling	212
Figure 6-18.	Example Probability Distribution of a Target Milestone.....	214
Figure 6-19.	Schedule Compression Comparison.....	215
Figure 6-20.	Relationship Between Product Vision, Release Planning, and Iteration Planning	216

Figure 6-21.	Project Schedule Presentations—Examples	219
Figure 6-22.	Control Schedule: Inputs, Tools & Techniques, and Outputs.....	222
Figure 6-23.	Control Schedule: Data Flow Diagram	223
Figure 6-24.	Iteration Burndown Chart.....	226
Figure 7-1.	Project Cost Management Overview.....	232
Figure 7-2.	Plan Cost Management: Inputs, Tools & Techniques, and Outputs.....	235
Figure 7-3.	Plan Cost Management: Data Flow Diagram	235
Figure 7-4.	Estimate Costs: Inputs, Tools & Techniques, and Outputs	240
Figure 7-5.	Estimate Costs: Data Flow Diagram	240
Figure 7-6.	Determine Budget: Inputs, Tools & Techniques, and Outputs	248
Figure 7-7.	Determine Budget: Data Flow Diagram	249
Figure 7-8.	Project Budget Components.....	255
Figure 7-9.	Cost Baseline, Expenditures, and Funding Requirements	255
Figure 7-10.	Control Costs: Inputs, Tools & Techniques, and Outputs.....	257
Figure 7-11.	Control Costs: Data Flow Diagram	258
Figure 7-12.	Earned Value, Planned Value, and Actual Costs	264
Figure 7-13.	To-Complete Performance Index (TCPI).....	268
Figure 8-1.	Project Quality Management Overview.....	272
Figure 8-2.	Major Project Quality Management Process Interrelations	273
Figure 8-3.	Plan Quality Management: Inputs, Tools & Techniques, and Outputs	277
Figure 8-4.	Plan Quality Management: Data Flow Diagram.....	278
Figure 8-5.	Cost of Quality.....	283
Figure 8-6.	The SIPOC Model.....	285
Figure 8-7.	Manage Quality: Inputs, Tools & Techniques, and Outputs	288
Figure 8-8.	Manage Quality: Data Flow Diagram	289
Figure 8-9.	Cause-and-Effect Diagram.....	294

Figure 8-10.	Control Quality: Inputs, Tools & Techniques, and Outputs	298
Figure 8-11.	Control Quality: Data Flow Diagram.....	299
Figure 8-12.	Check Sheets	302
Figure 9-1.	Project Resource Management Overview.....	308
Figure 9-2.	Plan Resource Management: Inputs, Tools & Techniques, and Outputs	312
Figure 9-3.	Plan Resource Management: Data Flow Diagram.....	313
Figure 9-4.	Sample RACI Chart	317
Figure 9-5.	Estimate Activity Resources: Inputs, Tools & Techniques, and Outputs.....	321
Figure 9-6.	Estimate Activity Resources: Data Flow Diagram.....	321
Figure 9-7.	Sample Resource Breakdown Structure.....	327
Figure 9-8.	Acquire Resources: Inputs, Tools & Techniques, and Outputs.....	328
Figure 9-9.	Acquire Resources: Data Flow Diagram	329
Figure 9-10.	Develop Team: Inputs, Tools & Techniques, and Outputs.....	336
Figure 9-11.	Develop Team: Data Flow Diagram	337
Figure 9-12.	Manage Team: Inputs, Tools & Techniques, and Outputs.....	345
Figure 9-13.	Manage Team: Data Flow Diagram	346
Figure 9-14.	Control Resources: Inputs, Tools & Techniques, and Outputs.....	352
Figure 9-15.	Control Resources: Data Flow Diagram.....	353
Figure 10-1.	Project Communications Overview.....	360
Figure 10-2.	Plan Communications Management: Inputs, Tools & Techniques, and Outputs.....	366
Figure 10-3.	Plan Communications Management: Data Flow Diagram	367
Figure 10-4.	Communication Model for Cross-Cultural Communication	373
Figure 10-5.	Manage Communications: Inputs, Tools & Techniques, and Outputs.....	379
Figure 10-6.	Manage Communications: Data Flow Diagram	380
Figure 10-7.	Monitor Communications: Inputs, Tools & Techniques, and Outputs	388

Figure 10-8.	Monitor Communications: Data Flow Diagram	389
Figure 11-1.	Project Risk Management Overview	396
Figure 11-2.	Plan Risk Management: Inputs, Tools & Techniques, and Outputs.....	401
Figure 11-3.	Plan Risk Management: Data Flow Diagram	402
Figure 11-4.	Extract from Sample Risk Breakdown Structure (RBS)	406
Figure 11-5.	Example Probability and Impact Matrix with Scoring Scheme	408
Figure 11-6.	Identify Risks: Inputs, Tools & Techniques, and Outputs	409
Figure 11-7.	Identify Risks: Data Flow Diagram	410
Figure 11-8.	Perform Qualitative Risk Analysis: Inputs, Tools & Techniques, and Outputs.....	419
Figure 11-9.	Perform Qualitative Risk Analysis: Data Flow Diagram	420
Figure 11-10.	Example Bubble Chart Showing Detectability, Proximity, and Impact Value.....	426
Figure 11-11.	Perform Quantitative Risk Analysis: Inputs, Tools & Techniques, and Outputs.....	428
Figure 11-12.	Perform Quantitative Risk Analysis: Data Flow Diagram.....	429
Figure 11-13.	Example S-Curve from Quantitative Cost Risk Analysis	433
Figure 11-14.	Example Tornado Diagram	434
Figure 11-15.	Example Decision Tree	435
Figure 11-16.	Plan Risk Responses: Inputs, Tools & Techniques, and Outputs	437
Figure 11-17.	Plan Risk Responses: Data Flow Diagram.....	438
Figure 11-18.	Implement Risk Responses: Inputs, Tools & Techniques, and Outputs	449
Figure 11-19.	Implement Risk Responses: Data Flow Diagram	449
Figure 11-20.	Monitor Risks: Inputs, Tools & Techniques, and Outputs.....	453
Figure 11-21.	Monitor Risks: Data Flow Diagram	454
Figure 12-1.	Project Procurement Management Overview	460

Figure 12-2.	Plan Procurement Management: Inputs, Tools & Techniques, and Outputs	466
Figure 12-3.	Plan Procurement Management: Data Flow Diagram	467
Figure 12-4.	Conduct Procurements: Inputs, Tools & Techniques, and Outputs	482
Figure 12-5.	Conduct Procurements: Data Flow Diagram	483
Figure 12-6.	Control Procurements: Inputs, Tools & Techniques, and Outputs.....	492
Figure 12-7.	Control Procurements: Data Flow Diagram	493
Figure 13-1.	Project Stakeholder Management Overview	504
Figure 13-2.	Identify Stakeholders: Inputs, Tools & Techniques, and Outputs.....	507
Figure 13-3.	Identify Stakeholders: Data Flow Diagram.....	508
Figure 13-4.	Plan Stakeholder Engagement: Inputs, Tools & Techniques, and Outputs	516
Figure 13-5.	Plan Stakeholder Engagement: Data Flow Diagram	517
Figure 13-6.	Stakeholder Engagement Assessment Matrix	522
Figure 13-7.	Manage Stakeholder Engagement: Inputs, Tools & Techniques, and Outputs.....	523
Figure 13-8.	Manage Stakeholder Engagement: Data Flow Diagram	524
Figure 13-9.	Monitor Stakeholder Engagement: Inputs, Tools & Techniques, and Outputs.....	530
Figure 13-10.	Monitor Stakeholder Engagement: Data Flow Diagram.....	531
Table 1-1.	Examples of Factors that Lead to the Creation of a Project	9
Table 1-2.	Comparative Overview of Portfolios, Programs, and Projects	13
Table 1-3.	Description of <i>PMBOK® Guide</i> Key Components	18
Table 1-4.	Project Management Process Group and Knowledge Area Mapping.....	25
Table 1-5.	Project Business Documents	29
Table 2-1.	Influences of Organizational Structures on Projects	47
Table 3-1.	Team Management and Team Leadership Compared	64

Table 4-1.	Project Management Plan and Project Documents.....	89
Table 5-1.	Elements of the Project Charter and Project Scope Statement	155
Table 7-1.	Earned Value Calculations Summary Table	267
Table 11-1.	Example of Definitions for Probability and Impacts	407
Table 12-1.	Comparison of Procurement Documentation	481

PART 2.

The Standard For Project Management

Figure 1-1.	Example of Portfolio, Program, and Project Management Interfaces	544
Figure 1-2.	Generic Depiction of a Project Life Cycle.....	548
Figure 1-3.	Impact of Variables Over Time	549
Figure 1-4.	Examples of Project Stakeholders	551
Figure 1-5.	Example of Process Group Interactions Within a Project or Phase.....	555
Figure 2-1.	Project Boundaries	562
Figure 2-2.	Initiating Process Group.....	562
Figure 2-3.	Develop Project Charter: Inputs and Outputs	563
Figure 2-4.	Identify Stakeholders: Inputs and Outputs.....	563
Figure 3-1.	Planning Process Group	566
Figure 3-2.	Develop Project Management Plan: Inputs and Outputs	567
Figure 3-3.	Plan Scope Management: Inputs and Outputs	567
Figure 3-4.	Collect Requirements: Inputs and Outputs.....	568
Figure 3-5.	Define Scope: Inputs and Outputs	569
Figure 3-6.	Create WBS: Inputs and Outputs.....	570
Figure 3-7.	Plan Schedule Management: Inputs and Outputs.....	571
Figure 3-8.	Define Activities: Inputs and Outputs	572

Figure 3-9.	Sequence Activities: Inputs and Outputs.....	573
Figure 3-10.	Estimate Activity Durations: Inputs and Outputs	574
Figure 3-11.	Develop Schedule: Inputs and Outputs.....	575
Figure 3-12.	Plan Cost Management: Inputs and Outputs	577
Figure 3-13.	Estimate Costs: Inputs and Outputs.....	577
Figure 3-14.	Determine Budget: Inputs and Outputs	579
Figure 3-15.	Plan Quality Management: Inputs and Outputs.....	580
Figure 3-16.	Plan Resource Management: Inputs and Outputs.....	581
Figure 3-17.	Estimate Activity Resources: Inputs and Outputs	583
Figure 3-18.	Plan Communications Management: Inputs and Outputs	584
Figure 3-19.	Plan Risk Management: Inputs and Outputs	585
Figure 3-20.	Identify Risks: Inputs and Outputs.....	586
Figure 3-21.	Perform Qualitative Risk Analysis: Inputs and Outputs	588
Figure 3-22.	Perform Quantitative Risk Analysis: Inputs and Outputs.....	589
Figure 3-23.	Plan Risk Responses: Inputs and Outputs.....	590
Figure 3-24.	Plan Procurement Management: Inputs and Outputs.....	592
Figure 3-25.	Plan Stakeholder Engagement: Inputs and Outputs	594
Figure 4-1.	Executing Process Group	596
Figure 4-2.	Direct and Manage Project Work: Inputs and Outputs.....	597
Figure 4-3.	Manage Project Knowledge: Inputs and Outputs	598
Figure 4-4.	Manage Quality: Inputs and Outputs	599
Figure 4-5.	Acquire Resources: Inputs and Outputs	601
Figure 4-6.	Develop Team: Inputs and Outputs	602
Figure 4-7.	Manage Team: Inputs and Outputs	604
Figure 4-8.	Manage Communications: Inputs and Outputs	605
Figure 4-9.	Implement Risk Responses: Inputs and Outputs	607

Figure 4-10.	Conduct Procurements: Inputs and Outputs	608
Figure 4-11.	Manage Stakeholder Engagement: Inputs and Outputs	610
Figure 5-1.	Monitoring and Controlling Process Group	614
Figure 5-2.	Monitor and Control Project Work: Inputs and Outputs	615
Figure 5-3.	Perform Integrated Change Control: Inputs and Outputs.....	616
Figure 5-4.	Validate Scope: Inputs and Outputs.....	618
Figure 5-5.	Control Scope: Inputs and Outputs	619
Figure 5-6.	Control Schedule: Inputs and Outputs	621
Figure 5-7.	Control Costs: Inputs and Outputs	622
Figure 5-8.	Control Quality: Inputs and Outputs.....	624
Figure 5-9.	Control Resources: Inputs and Outputs.....	625
Figure 5-10.	Monitor Communications: Inputs and Outputs	627
Figure 5-11.	Monitor Risks: Inputs and Outputs	628
Figure 5-12.	Control Procurements: Inputs and Outputs	630
Figure 5-13.	Monitor Stakeholder Engagement: Inputs and Outputs.....	631
Figure 6-1.	Closing Process Group	633
Figure 6-2.	Close Project or Phase: Inputs and Outputs	634
Table 1-1.	Project Management Process Group and Knowledge Area Mapping.....	556
Table 1-2.	Project Management Plan and Project Documents.....	559

**PART 3.
APPENDICES, GLOSSARY, AND INDEX**

Figure X3-1.	The Continuum of Project Life Cycles	666
Figure X3-2.	Level of Effort for Process Groups across Iteration Cycles	667
Figure X3-3.	Relationship of Process Groups in Continuous Phases	668
Table X1-1.	Section 4 Changes	645
Table X1-2.	Section 6 Changes	646
Table X1-3.	Section 8 Changes	646
Table X1-4.	Section 9 Changes	647
Table X1-5.	Section 10 Changes	648
Table X1-6.	Section 11 Changes	648
Table X1-7.	Section 12 Changes	649
Table X1-8.	Section 13 Changes	650
Table X6-1.	Categorization and Index of Tools and Techniques.....	686



Part 1

A Guide to the Project Management Body of Knowledge *(PMBOK® GUIDE)*

The information contained in this part is not an American National Standard (ANS) and has not been processed in accordance with ANSI's requirements for an ANS. As such, the information in this part may contain material that has not been subjected to public review or a consensus process. In addition, it does not contain requirements necessary for conformance to an ANS standard.

1

INTRODUCTION

1.1 OVERVIEW AND PURPOSE OF THIS GUIDE

Project management is not new. It has been in use for hundreds of years. Examples of project outcomes include:

- ◆ Pyramids of Giza,
- ◆ Olympic games,
- ◆ Great Wall of China,
- ◆ Taj Mahal,
- ◆ Publication of a children's book,
- ◆ Panama Canal,
- ◆ Development of commercial jet airplanes,
- ◆ Polio vaccine,
- ◆ Human beings landing on the moon,
- ◆ Commercial software applications,
- ◆ Portable devices to use the global positioning system (GPS), and
- ◆ Placement of the International Space Station into Earth's orbit.

The outcomes of these projects were the result of leaders and managers applying project management practices, principles, processes, tools, and techniques to their work. The managers of these projects used a set of key skills and applied knowledge to satisfy their customers and other people involved in and affected by the project. By the mid-20th century, project managers began the work of seeking recognition for project management as a profession. One aspect of this work involved obtaining agreement on the content of the body of knowledge (BOK) called project management. This BOK became known as the Project Management Body of Knowledge (PMBOK). The Project Management Institute (PMI) produced a baseline of charts and glossaries for the PMBOK. Project managers soon realized that no single book could contain the entire PMBOK. Therefore, PMI developed and published *A Guide to the Project Management Body of Knowledge (PMBOK® Guide)*.

PMI defines the project management body of knowledge (PMBOK) as a term that describes the knowledge within the profession of project management. The project management body of knowledge includes proven traditional practices that are widely applied as well as innovative practices that are emerging in the profession.

The body of knowledge (BOK) includes both published and unpublished materials. This body of knowledge is constantly evolving. This *PMBOK® Guide* identifies a subset of the project management body of knowledge that is generally recognized as good practice.

- ◆ *Generally recognized* means the knowledge and practices described are applicable to most projects most of the time, and there is consensus about their value and usefulness.
- ◆ *Good practice* means there is general agreement that the application of the knowledge, skills, tools, and techniques to project management processes can enhance the chance of success over many projects in delivering the expected business values and results.

The project manager works with the project team and other stakeholders to determine and use the appropriate generally recognized good practices for each project. Determining the appropriate combination of processes, inputs, tools, techniques, outputs and life cycle phases to manage a project is referred to as “tailoring” the application of the knowledge described in this guide.

This *PMBOK® Guide* is different from a methodology. A methodology is a system of practices, techniques, procedures, and rules used by those who work in a discipline. This *PMBOK® Guide* is a foundation upon which organizations can build methodologies, policies, procedures, rules, tools and techniques, and life cycle phases needed to practice project management.

1.1.1 THE STANDARD FOR PROJECT MANAGEMENT

This guide is based on *The Standard for Project Management* [1]. A standard is a document established by an authority, custom, or general consent as a model or example. As an American National Standards Institute (ANSI) standard, *The Standard for Project Management* was developed using a process based on the concepts of consensus, openness, due process, and balance. *The Standard for Project Management* is a foundational reference for PMI’s project management professional development programs and the practice of project management. Because project management needs to be tailored to fit the needs of the project, the standard and the guide are both based on *descriptive* practices, rather than *prescriptive* practices. Therefore, the standard identifies the processes that are considered good practices on most projects, most of the time. The standard also identifies the inputs and outputs that are usually associated with those processes. The standard does not require that any particular process or practice be performed. *The Standard for Project Management* is included as Part II of *A Guide to the Project Management Body of Knowledge (PMBOK® Guide)*.

The *PMBOK® Guide* provides more detail about key concepts, emerging trends, considerations for tailoring the project management processes, and information on how tools and techniques are applied to projects. Project managers may use one or more methodologies to implement the project management processes outlined in the standard.

The scope of this guide is limited to the discipline of project management, rather than the full spectrum of portfolios, programs, and projects. Portfolios and programs will be addressed only to the degree they interact with projects. PMI publishes two other standards that address the management of portfolios and programs:

- ◆ *The Standard for Portfolio Management* [2], and
- ◆ *The Standard for Program Management* [3].

1.1.2 COMMON VOCABULARY

A common vocabulary is an essential element of a professional discipline. *The PMI Lexicon of Project Management Terms* [4] provides the foundational professional vocabulary that can be consistently used by organizations, portfolio, program, and project managers and other project stakeholders. The *Lexicon* will continue to evolve over time. The glossary to this guide includes the vocabulary in the *Lexicon* along with additional definitions. There may be other industry-specific terms used in projects that are defined by that industry's literature.

1.1.3 CODE OF ETHICS AND PROFESSIONAL CONDUCT

PMI publishes the *Code of Ethics and Professional Conduct* [5] to instill confidence in the project management profession and to help an individual in making wise decisions, particularly when faced with difficult situations where the individual may be asked to compromise his or her integrity or values. The values that the global project management community defined as most important were responsibility, respect, fairness, and honesty. The *Code of Ethics and Professional Conduct* affirms these four values as its foundation.

The *Code of Ethics and Professional Conduct* includes both aspirational standards and mandatory standards. The aspirational standards describe the conduct that practitioners, who are also PMI members, certification holders, or volunteers, strive to uphold. Although adherence to the aspirational standards is not easily measured, conduct in accordance with these is an expectation for those who consider themselves to be professionals—it is not optional. The mandatory standards establish firm requirements and, in some cases, limit or prohibit practitioner behavior. Practitioners who are also PMI members, certification holders, or volunteers and who do not conduct themselves in accordance with these standards will be subject to disciplinary procedures before PMI's Ethics Review Committee.

1.2 FOUNDATIONAL ELEMENTS

This section describes foundational elements necessary for working in and understanding the discipline of project management.

1.2.1 PROJECTS

A project is a temporary endeavor undertaken to create a unique product, service, or result.

- ◆ **Unique product, service, or result.** Projects are undertaken to fulfill objectives by producing deliverables. An objective is defined as an outcome toward which work is to be directed, a strategic position to be attained, a purpose to be achieved, a result to be obtained, a product to be produced, or a service to be performed. A deliverable is defined as any unique and verifiable product, result, or capability to perform a service that is required to be produced to complete a process, phase, or project. Deliverables may be tangible or intangible.

Fulfillment of project objectives may produce one or more of the following deliverables:

- A unique product that can be either a component of another item, an enhancement or correction to an item, or a new end item in itself (e.g., the correction of a defect in an end item);
- A unique service or a capability to perform a service (e.g., a business function that supports production or distribution);
- A unique result, such as an outcome or document (e.g., a research project that develops knowledge that can be used to determine whether a trend exists or a new process will benefit society); and
- A unique combination of one or more products, services, or results (e.g., a software application, its associated documentation, and help desk services).

Repetitive elements may be present in some project deliverables and activities. This repetition does not change the fundamental and unique characteristics of the project work. For example, office buildings can be constructed with the same or similar materials and by the same or different teams. However, each building project remains unique in key characteristics (e.g., location, design, environment, situation, people involved).

Projects are undertaken at all organizational levels. A project can involve a single individual or a group. A project can involve a single organizational unit or multiple organizational units from multiple organizations.

Examples of projects include but are not limited to:

- Developing a new pharmaceutical compound for market,
 - Expanding a tour guide service,
 - Merging two organizations,
 - Improving a business process within an organization,
 - Acquiring and installing a new computer hardware system for use in an organization,
 - Exploring for oil in a region,
 - Modifying a computer software program used in an organization,
 - Conducting research to develop a new manufacturing process, and
 - Constructing a building.
- ◆ **Temporary endeavor.** The temporary nature of projects indicates that a project has a definite beginning and end. Temporary does not necessarily mean a project has a short duration. The end of the project is reached when one or more of the following is true:
- The project's objectives have been achieved;
 - The objectives will not or cannot be met;
 - Funding is exhausted or no longer available for allocation to the project;
 - The need for the project no longer exists (e.g., the customer no longer wants the project completed, a change in strategy or priority ends the project, the organizational management provides direction to end the project);
 - The human or physical resources are no longer available; or
 - The project is terminated for legal cause or convenience.

Projects are temporary, but their deliverables may exist beyond the end of the project. Projects may produce deliverables of a social, economic, material, or environmental nature. For example, a project to build a national monument will create a deliverable expected to last for centuries.



- ◆ **Projects drive change.** Projects drive change in organizations. From a business perspective, a project is aimed at moving an organization from one state to another state in order to achieve a specific objective (see Figure 1-1). Before the project begins, the organization is commonly referred to as being in the current state. The desired result of the change driven by the project is described as the future state.

For some projects, this may involve creating a transition state where multiple steps are made along a continuum to achieve the future state. The successful completion of a project results in the organization moving to the future state and achieving the specific objective. For more information on project management and change, see *Managing Change in Organizations: A Practice Guide* [6].

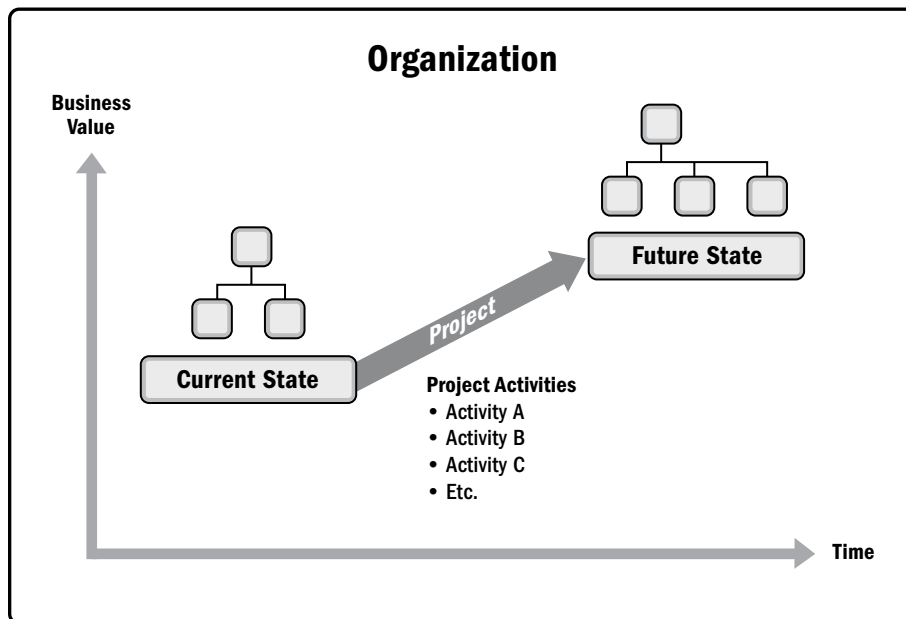

Figure 1-1. Organizational State Transition via a Project

- ◆ **Projects enable business value creation.** PMI defines business value as the net quantifiable benefit derived from a business endeavor. The benefit may be tangible, intangible, or both. In business analysis, business value is considered the return, in the form of elements such as time, money, goods, or intangibles in return for something exchanged (see *Business Analysis for Practitioners: A Practice Guide*, p. 185 [7]).

Business value in projects refers to the benefit that the results of a specific project provide to its stakeholders. The benefit from projects may be tangible, intangible, or both.

Examples of tangible elements include:

- Monetary assets,
- Stockholder equity,
- Utility,
- Fixtures,
- Tools, and
- Market share.

Examples of intangible elements include:

- Goodwill,
- Brand recognition,
- Public benefit,
- Trademarks,
- Strategic alignment, and
- Reputation.

- ◆ **Project Initiation Context.** Organizational leaders initiate projects in response to factors acting upon their organizations. There are four fundamental categories for these factors, which illustrate the context of a project (see Figure 1-2):
 - Meet regulatory, legal, or social requirements;
 - Satisfy stakeholder requests or needs;
 - Implement or change business or technological strategies; and
 - Create, improve, or fix products, processes, or services.

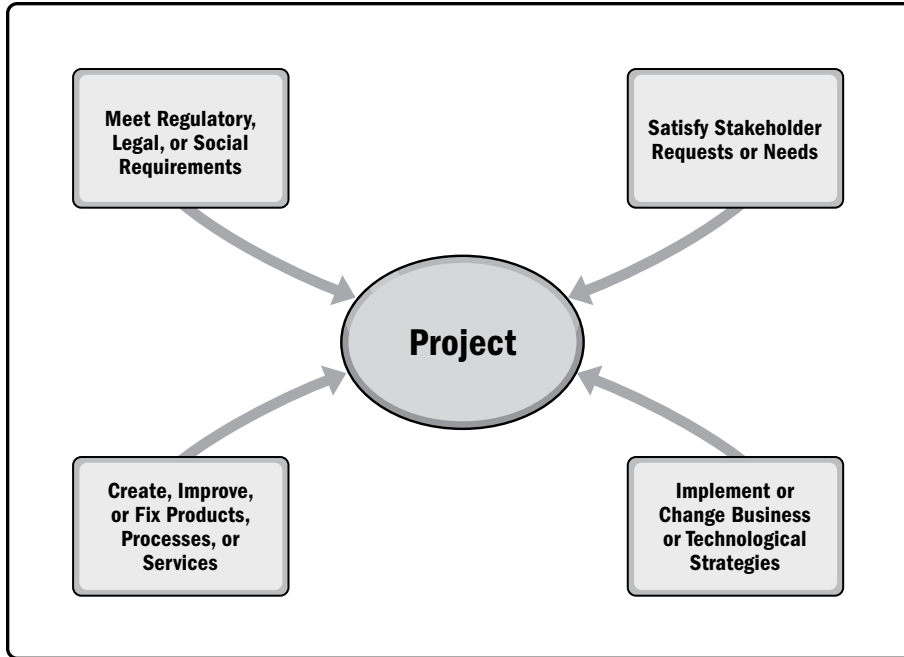

Figure 1-2. Project Initiation Context

These factors influence an organization’s ongoing operations and business strategies. Leaders respond to these factors in order to keep the organization viable. Projects provide the means for organizations to successfully make the changes necessary to deal with these factors. These factors ultimately should link to the strategic objectives of the organization and the business value of each project.

Table 1-1 illustrates how example factors could align with one or more of the fundamental factor categories.

Table 1-1. Examples of Factors that Lead to the Creation of a Project

Specific Factor	Examples of Specific Factors	Meet Regulatory, Legal, or Social Requirements	Satisfy Stakeholder Requests or Needs	Create, Improve, or Fix Products, Processes, or Services	Implement or Change Business or Technological Strategies
New technology	An electronics firm authorizes a new project to develop a faster, cheaper, and smaller laptop based on advances in computer memory and electronics technology			X	X
Competitive forces	Lower pricing on products by a competitor results in the need to lower production costs to remain competitive				X
Material issues	A municipal bridge developed cracks in some support members resulting in a project to fix the problems	X		X	
Political changes	A newly elected official instigating project funding changes to a current project				X
Market demand	A car company authorizes a project to build more fuel-efficient cars in response to gasoline shortages		X	X	X
Economic changes	An economic downturn results in a change in the priorities for a current project				X
Customer request	An electric utility authorizes a project to build a substation to serve a new industrial park		X	X	
Stakeholder demands	A stakeholder requires that a new output be produced by the organization		X		
Legal requirement	A chemical manufacturer authorizes a project to establish guidelines for the proper handling of a new toxic material	X			
Business process improvements	An organization implements a project resulting from a Lean Six Sigma value stream mapping exercise			X	
Strategic opportunity or business need	A training company authorizes a project to create a new course to increase its revenues			X	X
Social need	A nongovernmental organization in a developing country authorizes a project to provide potable water systems, latrines, and sanitation education to communities suffering from high rates of infectious diseases		X		
Environmental considerations	A public company authorizes a project to create a new service for electric car sharing to reduce pollution			X	X

1.2.2 THE IMPORTANCE OF PROJECT MANAGEMENT

Project management is the application of knowledge, skills, tools, and techniques to project activities to meet the project requirements. Project management is accomplished through the appropriate application and integration of the project management processes identified for the project. Project management enables organizations to execute projects effectively and efficiently.

Effective project management helps individuals, groups, and public and private organizations to:

- ◆ Meet business objectives;
- ◆ Satisfy stakeholder expectations;
- ◆ Be more predictable;
- ◆ Increase chances of success;
- ◆ Deliver the right products at the right time;
- ◆ Resolve problems and issues;
- ◆ Respond to risks in a timely manner;
- ◆ Optimize the use of organizational resources;
- ◆ Identify, recover, or terminate failing projects;
- ◆ Manage constraints (e.g., scope, quality, schedule, costs, resources);
- ◆ Balance the influence of constraints on the project (e.g., increased scope may increase cost or schedule); and
- ◆ Manage change in a better manner.

Poorly managed projects or the absence of project management may result in:

- ◆ Missed deadlines,
- ◆ Cost overruns,
- ◆ Poor quality,
- ◆ Rework,
- ◆ Uncontrolled expansion of the project,
- ◆ Loss of reputation for the organization,
- ◆ Unsatisfied stakeholders, and
- ◆ Failure in achieving the objectives for which the project was undertaken.

Projects are a key way to create value and benefits in organizations. In today's business environment, organizational leaders need to be able to manage with tighter budgets, shorter timelines, scarcity of resources, and rapidly changing technology. The business environment is dynamic with an accelerating rate of change. To remain competitive in the world economy, companies are embracing project management to consistently deliver business value.

Effective and efficient project management should be considered a strategic competency within organizations. It enables organizations to:

- ◆ Tie project results to business goals,
- ◆ Compete more effectively in their markets,
- ◆ Sustain the organization, and
- ◆ Respond to the impact of business environment changes on projects by appropriately adjusting project management plans (see Section 4.2).

1.2.3 RELATIONSHIP OF PROJECT, PROGRAM, PORTFOLIO, AND OPERATIONS MANAGEMENT

1.2.3.1 OVERVIEW

Using project management processes, tools, and techniques puts in place a sound foundation for organizations to achieve their goals and objectives. A project may be managed in three separate scenarios: as a stand-alone project (outside of a portfolio or program), within a program, or within a portfolio. Project managers interact with portfolio and program managers when a project is within a program or portfolio. For example, multiple projects may be needed to accomplish a set of goals and objectives for an organization. In those situations, projects may be grouped together into a program. A program is defined as a group of related projects, subsidiary programs, and program activities managed in a coordinated manner to obtain benefits not available from managing them individually. Programs are not large projects. A very large project may be referred to as a megaproject. As a guideline, megaprojects cost US\$1 billion or more, affect 1 million or more people, and run for years.

Some organizations may employ the use of a project portfolio to effectively manage multiple programs and projects that are underway at any given time. A portfolio is defined as projects, programs, subsidiary portfolios, and operations managed as a group to achieve strategic objectives. Figure 1-3 illustrates an example of how portfolios, programs, projects, and operations are related in a specific situation.

Program management and portfolio management differ from project management in their life cycles, activities, objectives, focus, and benefits. However, portfolios, programs, projects, and operations often engage with the same stakeholders and may need to use the same resources (see Figure 1-3), which may result in a conflict in the organization. This type of a situation increases the need for coordination within the organization through the use of portfolio, program, and project management to achieve a workable balance in the organization.

Figure 1-3 illustrates a sample portfolio structure indicating relationships between the programs, projects, shared resources, and stakeholders. The portfolio components are grouped together in order to facilitate the effective governance and management of the work that helps to achieve organizational strategies and priorities. Organizational and portfolio planning impact the components by means of prioritization based on risk, funding, and other considerations. The portfolio view allows organizations to see how the strategic goals are reflected in the portfolio. This portfolio view also enables the implementation and coordination of appropriate portfolio, program, and project governance. This coordinated governance allows authorized allocation of human, financial, and physical resources based on expected performance and benefits.

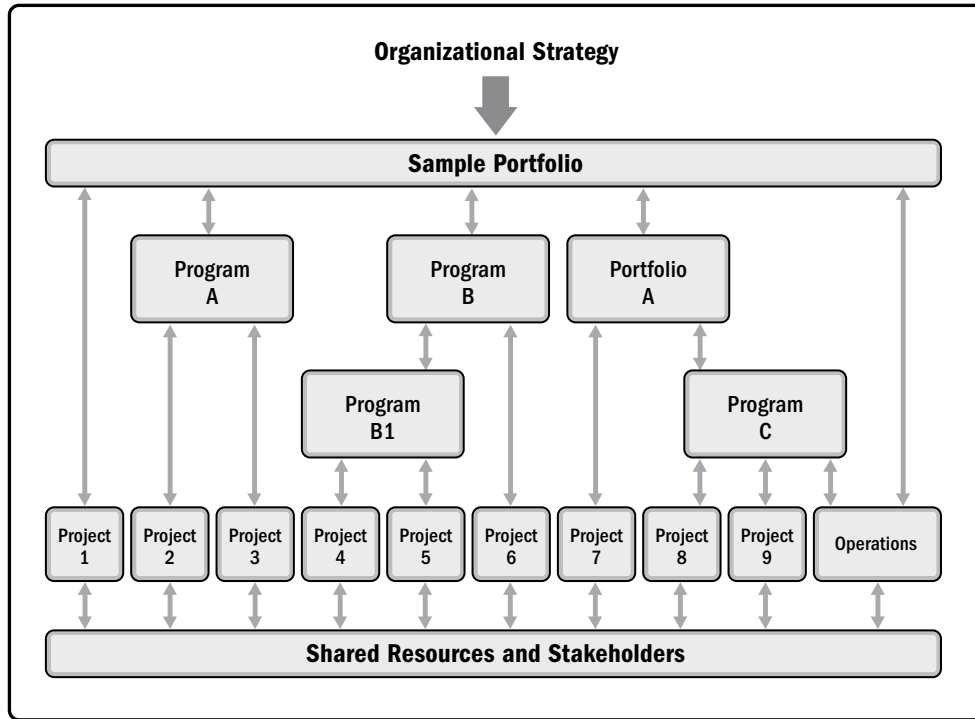

Figure 1-3. Portfolio, Programs, Projects, and Operations

Looking at project, program, and portfolio management from an organizational perspective:

- ◆ Program and project management focus on doing programs and projects the “right” way; and
- ◆ Portfolio management focuses on doing the “right” programs and projects.

Table 1-2 gives a comparative overview of portfolios, programs, and projects.

Table 1-2. Comparative Overview of Portfolios, Programs, and Projects

Organizational Project Management			
	Projects	Programs	Portfolios
Definition	A project is a temporary endeavor undertaken to create a unique product, service, or result.	A program is a group of related projects, subsidiary programs, and program activities that are managed in a coordinated manner to obtain benefits not available from managing them individually.	A portfolio is a collection of projects, programs, subsidiary portfolios, and operations managed as a group to achieve strategic objectives.
Scope	Projects have defined objectives. Scope is progressively elaborated throughout the project life cycle.	Programs have a scope that encompasses the scopes of its program components. Programs produce benefits to an organization by ensuring that the outputs and outcomes of program components are delivered in a coordinated and complementary manner.	Portfolios have an organizational scope that changes with the strategic objectives of the organization.
Change	Project managers expect change and implement processes to keep change managed and controlled.	Programs are managed in a manner that accepts and adapts to change as necessary to optimize the delivery of benefits as the program's components deliver outcomes and/or outputs.	Portfolio managers continuously monitor changes in the broader internal and external environments.
Planning	Project managers progressively elaborate high-level information into detailed plans throughout the project life cycle.	Programs are managed using high-level plans that track the interdependencies and progress of program components. Program plans are also used to guide planning at the component level.	Portfolio managers create and maintain necessary processes and communication relative to the aggregate portfolio.
Management	Project managers manage the project team to meet the project objectives.	Programs are managed by program managers who ensure that program benefits are delivered as expected, by coordinating the activities of a program's components.	Portfolio managers may manage or coordinate portfolio management staff, or program and project staff that may have reporting responsibilities into the aggregate portfolio.
Monitoring	Project managers monitor and control the work of producing the products, services, or results that the project was undertaken to produce.	Program managers monitor the progress of program components to ensure the overall goals, schedules, budget, and benefits of the program will be met.	Portfolio managers monitor strategic changes and aggregate resource allocation, performance results, and risk of the portfolio.
Success	Success is measured by product and project quality, timeliness, budget compliance, and degree of customer satisfaction.	A program's success is measured by the program's ability to deliver its intended benefits to an organization, and by the program's efficiency and effectiveness in delivering those benefits.	Success is measured in terms of the aggregate investment performance and benefit realization of the portfolio.

1.2.3.2 PROGRAM MANAGEMENT

Program management is defined as the application of knowledge, skills, and principles to a program to achieve the program objectives and to obtain benefits and control not available by managing program components individually. A program component refers to projects and other programs within a program. Project management focuses on interdependencies within a project to determine the optimal approach for managing the project. Program management focuses on the interdependencies between projects and between projects and the program level to determine the optimal approach for managing them. Actions related to these program and project-level interdependencies may include:

- ◆ Aligning with the organizational or strategic direction that affects program and project goals and objectives;
- ◆ Allocating the program scope into program components;
- ◆ Managing interdependencies among the components of the program to best serve the program;
- ◆ Managing program risks that may impact multiple projects in the program;
- ◆ Resolving constraints and conflicts that affect multiple projects within the program;
- ◆ Resolving issues between component projects and the program level;
- ◆ Managing change requests within a shared governance framework;
- ◆ Allocating budgets across multiple projects within the program; and
- ◆ Assuring benefits realization from the program and component projects.

An example of a program is a new communications satellite system with projects for the design and construction of the satellite and the ground stations, the launch of the satellite, and the integration of the system.

For more information on program management, see *The Standard for Program Management* [3].



1.2.3.3 PORTFOLIO MANAGEMENT

A portfolio is defined as projects, programs, subsidiary portfolios, and operations managed as a group to achieve strategic objectives.

Portfolio management is defined as the centralized management of one or more portfolios to achieve strategic objectives. The programs or projects of the portfolio may not necessarily be interdependent or directly related.

The aim of portfolio management is to:

- ◆ Guide organizational investment decisions.
- ◆ Select the optimal mix of programs and projects to meet strategic objectives.
- ◆ Provide decision-making transparency.
- ◆ Prioritize team and physical resource allocation.
- ◆ Increase the likelihood of realizing the desired return on investment.
- ◆ Centralize the management of the aggregate risk profile of all components.

Portfolio management also confirms that the portfolio is consistent with and aligned with organizational strategies.

Maximizing the value of the portfolio requires careful examination of the components that comprise the portfolio. Components are prioritized so that those contributing the most to the organization's strategic objectives have the required financial, team, and physical resources.

For example, an infrastructure organization that has the strategic objective of maximizing the return on its investments may put together a portfolio that includes a mix of projects in oil and gas, power, water, roads, rail, and airports. From this mix, the organization may choose to manage related projects as one portfolio. All of the power projects may be grouped together as a power portfolio. Similarly, all of the water projects may be grouped together as a water portfolio. However, when the organization has projects in designing and constructing a power plant and then operates the power plant to generate energy, those related projects can be grouped in one program. Thus, the power program and similar water program become integral components of the portfolio of the infrastructure organization.

For more information on portfolio management, see *The Standard for Portfolio Management* [2].



1.2.3.4 OPERATIONS MANAGEMENT

Operations management is an area that is outside the scope of formal project management as described in this guide.

Operations management is concerned with the ongoing production of goods and/or services. It ensures that business operations continue efficiently by using the optimal resources needed to meet customer demands. It is concerned with managing processes that transform inputs (e.g., materials, components, energy, and labor) into outputs (e.g., products, goods, and/or services).

1.2.3.5 OPERATIONS AND PROJECT MANAGEMENT

Changes in business or organizational operations may be the focus of a project—especially when there are substantial changes to business operations as a result of a new product or service delivery. Ongoing operations are outside of the scope of a project; however, there are intersecting points where the two areas cross.

Projects can intersect with operations at various points during the product life cycle, such as;

- ◆ When developing a new product, upgrading a product, or expanding outputs;
- ◆ While improving operations or the product development process;
- ◆ At the end of the product life cycle; and
- ◆ At each closeout phase.

At each point, deliverables and knowledge are transferred between the project and operations for implementation of the delivered work. This implementation occurs through a transfer of project resources or knowledge to operations or through a transfer of operational resources to the project.

1.2.3.6 ORGANIZATIONAL PROJECT MANAGEMENT (OPM) AND STRATEGIES

Portfolios, programs, and projects are aligned with or driven by organizational strategies and differ in the way each contributes to the achievement of strategic goals:

- ◆ Portfolio management aligns portfolios with organizational strategies by selecting the right programs or projects, prioritizing the work, and providing the needed resources.
- ◆ Program management harmonizes its program components and controls interdependencies in order to realize specified benefits.
- ◆ Project management enables the achievement of organizational goals and objectives.

Within portfolios or programs, projects are a means of achieving organizational goals and objectives. This is often accomplished in the context of a strategic plan that is the primary factor guiding investments in projects. Alignment with the organization’s strategic business goals can be achieved through the systematic management of portfolios, programs, and projects through the application of organizational project management (OPM). OPM is defined as a framework in which portfolio, program, and project management are integrated with organizational enablers in order to achieve strategic objectives.

The purpose of OPM is to ensure that the organization undertakes the right projects and allocates critical resources appropriately. OPM also helps to ensure that all levels in the organization understand the strategic vision, the initiatives that support the vision, the objectives, and the deliverables. Figure 1-4 shows the organizational environment where strategy, portfolio, programs, projects, and operations interact.

For more information on OPM, refer to *Implementing Organizational Project Management: A Practice Guide* [8].

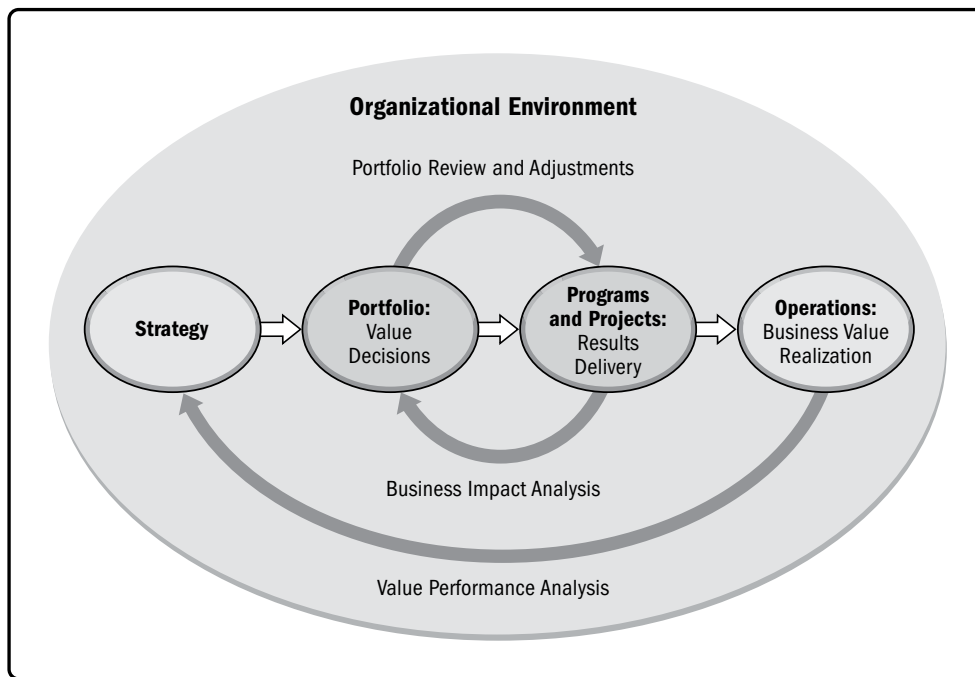

Figure 1-4. Organizational Project Management

1.2.4 COMPONENTS OF THE GUIDE

Projects comprise several key components that, when effectively managed, result in their successful completion. This guide identifies and explains these components. The various components interrelate to one another during the management of a project.

The key components are described briefly in Table 1-3. These components are more fully explained in the sections that follow the table.

Table 1-3. Description of *PMBOK® Guide* Key Components

<i>PMBOK® Guide</i> Key Component	Brief Description
Project life cycle (Section 1.2.4.1)	The series of phases that a project passes through from its start to its completion.
Project phase (Section 1.2.4.2)	A collection of logically related project activities that culminates in the completion of one or more deliverables.
Phase gate (Section 1.2.4.3)	A review at the end of a phase in which a decision is made to continue to the next phase, to continue with modification, or to end a program or project.
Project management processes (Section 1.2.4.4)	A systematic series of activities directed toward causing an end result where one or more inputs will be acted upon to create one or more outputs.
Project Management Process Group (Section 1.2.4.5)	A logical grouping of project management inputs, tools and techniques, and outputs. The Project Management Process Groups include Initiating, Planning, Executing, Monitoring and Controlling, and Closing. Project Management Process Groups are not project phases.
Project Management Knowledge Area (Section 1.2.4.6)	An identified area of project management defined by its knowledge requirements and described in terms of its component processes, practices, inputs, outputs, tools, and techniques.

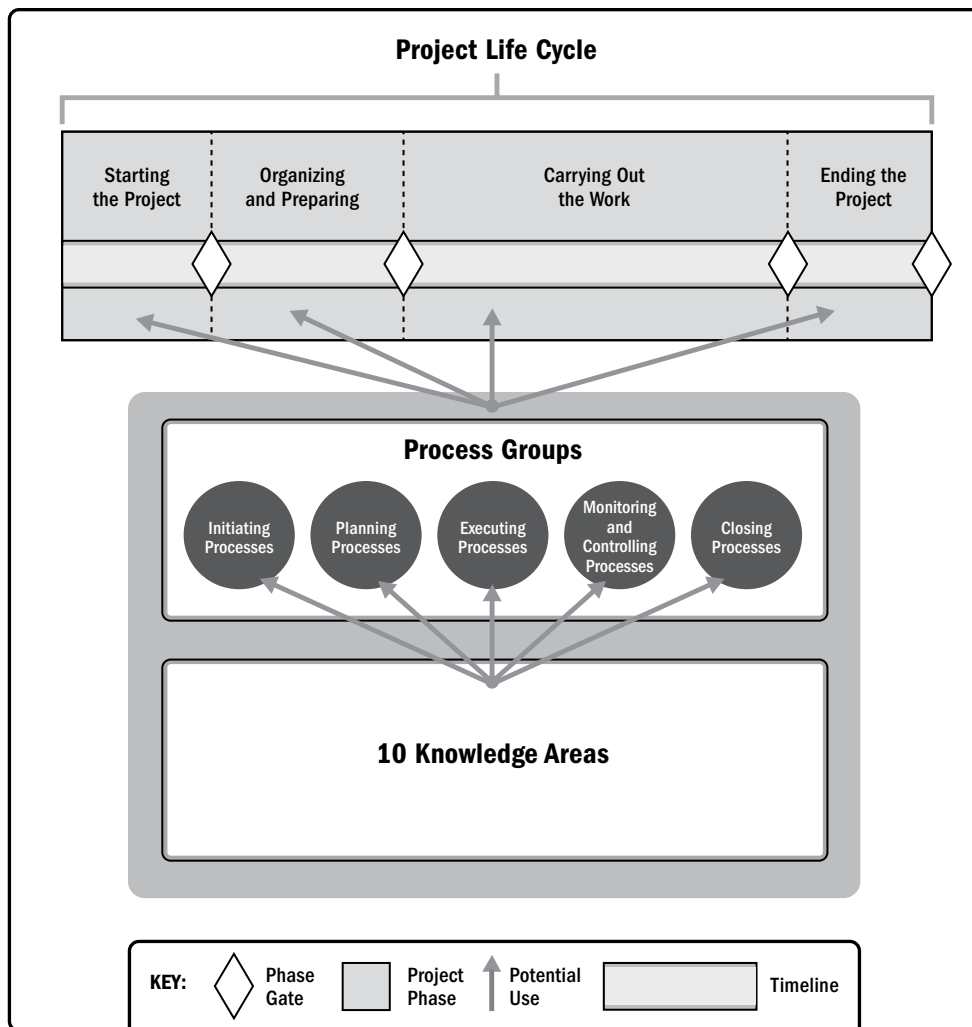

Figure 1-5. Interrelationship of *PMBOK® Guide* Key Components in Projects

1.2.4.1 PROJECT AND DEVELOPMENT LIFE CYCLES

A project life cycle is the series of phases that a project passes through from its start to its completion. It provides the basic framework for managing the project. This basic framework applies regardless of the specific project work involved. The phases may be sequential, iterative, or overlapping. All projects can be mapped to the generic life cycle shown in Figure 1-5.

Project life cycles can be predictive or adaptive. Within a project life cycle, there are generally one or more phases that are associated with the development of the product, service, or result. These are called a development life cycle. Development life cycles can be predictive, iterative, incremental, adaptive, or a hybrid model:

- ◆ In a predictive life cycle, the project scope, time, and cost are determined in the early phases of the life cycle. Any changes to the scope are carefully managed. Predictive life cycles may also be referred to as waterfall life cycles.
- ◆ In an iterative life cycle, the project scope is generally determined early in the project life cycle, but time and cost estimates are routinely modified as the project team's understanding of the product increases. Iterations develop the product through a series of repeated cycles, while increments successively add to the functionality of the product.
- ◆ In an incremental life cycle, the deliverable is produced through a series of iterations that successively add functionality within a predetermined time frame. The deliverable contains the necessary and sufficient capability to be considered complete only after the final iteration.
- ◆ Adaptive life cycles are agile, iterative, or incremental. The detailed scope is defined and approved before the start of an iteration. Adaptive life cycles are also referred to as agile or change-driven life cycles. See Appendix X3.
- ◆ A hybrid life cycle is a combination of a predictive and an adaptive life cycle. Those elements of the project that are well known or have fixed requirements follow a predictive development life cycle, and those elements that are still evolving follow an adaptive development life cycle.

It is up to the project management team to determine the best life cycle for each project. The project life cycle needs to be flexible enough to deal with the variety of factors included in the project. Life cycle flexibility may be accomplished by:

- ◆ Identifying the process or processes needed to be performed in each phase,
- ◆ Performing the process or processes identified in the appropriate phase,
- ◆ Adjusting the various attributes of a phase (e.g., name, duration, exit criteria, and entrance criteria).

Project life cycles are independent of product life cycles, which may be produced by a project. A product life cycle is the series of phases that represent the evolution of a product, from concept through delivery, growth, maturity, and to retirement.

1.2.4.2 PROJECT PHASE

A project phase is a collection of logically related project activities that culminates in the completion of one or more deliverables. The phases in a life cycle can be described by a variety of attributes. Attributes may be measurable and unique to a specific phase. Attributes may include but are not limited to:

- ◆ Name (e.g., Phase A, Phase B, Phase 1, Phase 2, proposal phase),
- ◆ Number (e.g., three phases in the project, five phases in the project),
- ◆ Duration (e.g., 1 week, 1 month, 1 quarter),
- ◆ Resource requirements (e.g., people, buildings, equipment),
- ◆ Entrance criteria for a project to move into that phase (e.g., specified approvals documented, specified documents completed), and
- ◆ Exit criteria for a project to complete a phase (e.g., documented approvals, completed documents, completed deliverables).

Projects may be separated into distinct phases or subcomponents. These phases or subcomponents are generally given names that indicate the type of work done in that phase. Examples of phase names include but are not limited to:

- ◆ Concept development,
- ◆ Feasibility study,
- ◆ Customer requirements,
- ◆ Solution development,
- ◆ Design,
- ◆ Prototype,
- ◆ Build,
- ◆ Test,
- ◆ Transition,
- ◆ Commissioning,
- ◆ Milestone review, and
- ◆ Lessons learned.

The project phases may be established based on various factors including, but not limited to:

- ◆ Management needs;
- ◆ Nature of the project;
- ◆ Unique characteristics of the organization, industry, or technology;
- ◆ Project elements including, but not limited to, technology, engineering, business, process, or legal; and
- ◆ Decision points (e.g., funding, project go/no-go, and milestone review).

Using multiple phases may provide better insight to managing the project. It also provides an opportunity to assess the project performance and take necessary corrective or preventive actions in subsequent phases. A key component used with project phases is the phase review (see Section 1.2.4.3).

1.2.4.3 PHASE GATE

A phase gate, is held at the end of a phase. The project's performance and progress are compared to project and business documents including but not limited to:

- ◆ Project business case (see Section 1.2.6.1),
- ◆ Project charter (see Section 4.1),
- ◆ Project management plan (see Section 4.2), and
- ◆ Benefits management plan (see Section 1.2.6.2).

A decision (e.g., go/no-go decision) is made as a result of this comparison to:

- ◆ Continue to the next phase,
- ◆ Continue to the next phase with modification,
- ◆ End the project,
- ◆ Remain in the phase, or
- ◆ Repeat the phase or elements of it.

Depending on the organization, industry, or type of work, phase gates may be referred to by other terms such as, phase review, stage gate, kill point, and phase entrance or phase exit. Organizations may use these reviews to examine other pertinent items which are beyond the scope of this guide, such as product-related documents or models.

1.2.4.4 PROJECT MANAGEMENT PROCESSES

The project life cycle is managed by executing a series of project management activities known as project management processes. Every project management process produces one or more outputs from one or more inputs by using appropriate project management tools and techniques. The output can be a deliverable or an outcome. Outcomes are an end result of a process. Project management processes apply globally across industries.

Project management processes are logically linked by the outputs they produce. Processes may contain overlapping activities that occur throughout the project. The output of one process generally results in either:

- ◆ An input to another process, or
- ◆ A deliverable of the project or project phase.

Figure 1-6 shows an example of how inputs, tools and techniques, and outputs relate to each other within a process, and with other processes.

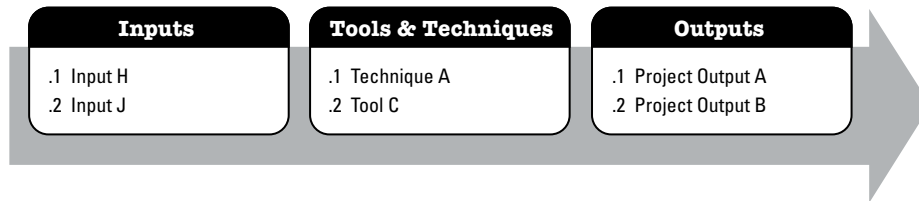

Figure 1-6. Example Process: Inputs, Tools & Techniques, and Outputs

The number of process iterations and interactions between processes varies based on the needs of the project. Processes generally fall into one of three categories:

- ◆ **Processes used once or at predefined points in the project.** The processes *Develop Project Charter* and *Close Project or Phase* are examples.
- ◆ **Processes that are performed periodically as needed.** The process *Acquire Resources* is performed as resources are needed. The process *Conduct Procurements* is performed prior to needing the procured item.
- ◆ **Processes that are performed continuously throughout the project.** The process *Define Activities* may occur throughout the project life cycle, especially if the project uses rolling wave planning or an adaptive development approach. Many of the monitoring and control processes are ongoing from the start of the project, until it is closed out.

Project management is accomplished through the appropriate application and integration of logically grouped project management processes. While there are different ways of grouping processes, the *PMBOK® Guide* groups processes into five categories called Process Groups.

1.2.4.5 PROJECT MANAGEMENT PROCESS GROUPS

A Project Management Process Group is a logical grouping of project management processes to achieve specific project objectives. Process Groups are independent of project phases. Project management processes are grouped into the following five Project Management Process Groups:

- ◆ **Initiating Process Group.** Those processes performed to define a new project or a new phase of an existing project by obtaining authorization to start the project or phase.
- ◆ **Planning Process Group.** Those processes required to establish the scope of the project, refine the objectives, and define the course of action required to attain the objectives that the project was undertaken to achieve.
- ◆ **Executing Process Group.** Those processes performed to complete the work defined in the project management plan to satisfy the project requirements.
- ◆ **Monitoring and Controlling Process Group.** Those processes required to track, review, and regulate the progress and performance of the project; identify any areas in which changes to the plan are required; and initiate the corresponding changes.
- ◆ **Closing Process Group.** Those processes performed to formally complete or close the project, phase, or contract.

Process flow diagrams are used throughout this guide. The project management processes are linked by specific inputs and outputs where the result or outcome of one process may become the input to another process that is not necessarily in the same Process Group. Note that Process Groups are not the same as project phases (see Section 1.2.4.2).

1.2.4.6 PROJECT MANAGEMENT KNOWLEDGE AREAS

In addition to Process Groups, processes are also categorized by Knowledge Areas. A Knowledge Area is an identified area of project management defined by its knowledge requirements and described in terms of its component processes, practices, inputs, outputs, tools, and techniques.

Although the Knowledge Areas are interrelated, they are defined separately from the project management perspective. The ten Knowledge Areas identified in this guide are used in most projects most of the time. The ten Knowledge Areas described in this guide are:

- ◆ **Project Integration Management.** Includes the processes and activities to identify, define, combine, unify, and coordinate the various processes and project management activities within the Project Management Process Groups.
- ◆ **Project Scope Management.** Includes the processes required to ensure the project includes all the work required, and only the work required, to complete the project successfully.

- ◆ **Project Schedule Management.** Includes the processes required to manage the timely completion of the project.
- ◆ **Project Cost Management.** Includes the processes involved in planning, estimating, budgeting, financing, funding, managing, and controlling costs so the project can be completed within the approved budget.
- ◆ **Project Quality Management.** Includes the processes for incorporating the organization's quality policy regarding planning, managing, and controlling project and product quality requirements, in order to meet stakeholders' expectations.
- ◆ **Project Resource Management.** Includes the processes to identify, acquire, and manage the resources needed for the successful completion of the project.
- ◆ **Project Communications Management.** Includes the processes required to ensure timely and appropriate planning, collection, creation, distribution, storage, retrieval, management, control, monitoring, and ultimate disposition of project information.
- ◆ **Project Risk Management.** Includes the processes of conducting risk management planning, identification, analysis, response planning, response implementation, and monitoring risk on a project.
- ◆ **Project Procurement Management.** Includes the processes necessary to purchase or acquire products, services, or results needed from outside the project team.
- ◆ **Project Stakeholder Management.** Includes the processes required to identify the people, groups, or organizations that could impact or be impacted by the project, to analyze stakeholder expectations and their impact on the project, and to develop appropriate management strategies for effectively engaging stakeholders in project decisions and execution.

The needs of a specific project may require one or more additional Knowledge Areas, for example, construction may require financial management or safety and health management. Table 1-4 maps the Project Management Process Groups and Knowledge Areas. Sections 4 through 13 provide more detail about each Knowledge Area. This table is an overview of the basic processes described in Sections 4 through 13.

Table 1-4. Project Management Process Group and Knowledge Area Mapping

Knowledge Areas	Project Management Process Groups				
	Initiating Process Group	Planning Process Group	Executing Process Group	Monitoring and Controlling Process Group	Closing Process Group
4. Project Integration Management	4.1 Develop Project Charter	4.2 Develop Project Management Plan	4.3 Direct and Manage Project Work 4.4 Manage Project Knowledge	4.5 Monitor and Control Project Work 4.6 Perform Integrated Change Control	4.7 Close Project or Phase
5. Project Scope Management		5.1 Plan Scope Management 5.2 Collect Requirements 5.3 Define Scope 5.4 Create WBS		5.5 Validate Scope 5.6 Control Scope	
6. Project Schedule Management		6.1 Plan Schedule Management 6.2 Define Activities 6.3 Sequence Activities 6.4 Estimate Activity Durations 6.5 Develop Schedule		6.6 Control Schedule	
7. Project Cost Management		7.1 Plan Cost Management 7.2 Estimate Costs 7.3 Determine Budget		7.4 Control Costs	
8. Project Quality Management		8.1 Plan Quality Management	8.2 Manage Quality	8.3 Control Quality	
9. Project Resource Management		9.1 Plan Resource Management 9.2 Estimate Activity Resources	9.3 Acquire Resources 9.4 Develop Team 9.5 Manage Team	9.6 Control Resources	
10. Project Communications Management		10.1 Plan Communications Management	10.2 Manage Communications	10.3 Monitor Communications	
11. Project Risk Management		11.1 Plan Risk Management 11.2 Identify Risks 11.3 Perform Qualitative Risk Analysis 11.4 Perform Quantitative Risk Analysis 11.5 Plan Risk Responses	11.6 Implement Risk Responses	11.7 Monitor Risks	
12. Project Procurement Management		12.1 Plan Procurement Management	12.2 Conduct Procurements	12.3 Control Procurements	
13. Project Stakeholder Management	13.1 Identify Stakeholders	13.2 Plan Stakeholder Engagement	13.3 Manage Stakeholder Engagement	13.4 Monitor Stakeholder Engagement	

1.2.4.7 PROJECT MANAGEMENT DATA AND INFORMATION

Throughout the life cycle of a project, a significant amount of data is collected, analyzed, and transformed. Project data are collected as a result of various processes and are shared within the project team. The collected data are analyzed in context, aggregated, and transformed to become project information during various processes. Information is communicated verbally or stored and distributed in various formats as reports. See Section 4.3 for more detail on this topic.

Project data are regularly collected and analyzed throughout the project life cycle. The following definitions identify key terminology regarding project data and information:

- ◆ **Work performance data.** The raw observations and measurements identified during activities performed to carry out the project work. Examples include reported percent of work physically completed, quality and technical performance measures, start and finish dates of schedule activities, number of change requests, number of defects, actual costs, actual durations, etc. Project data are usually recorded in a Project Management Information System (PMIS) (see Section 4.3.2.2) and in project documents.
- ◆ **Work performance information.** The performance data collected from various controlling processes, analyzed in context and integrated based on relationships across areas. Examples of performance information are status of deliverables, implementation status for change requests, and forecast estimates to complete.
- ◆ **Work performance reports.** The physical or electronic representation of work performance information compiled in project documents, which is intended to generate decisions or raise issues, actions, or awareness. Examples include status reports, memos, justifications, information notes, electronic dashboards, recommendations, and updates.

Figure 1-7 shows the flow of project information across the various processes used in managing the project.

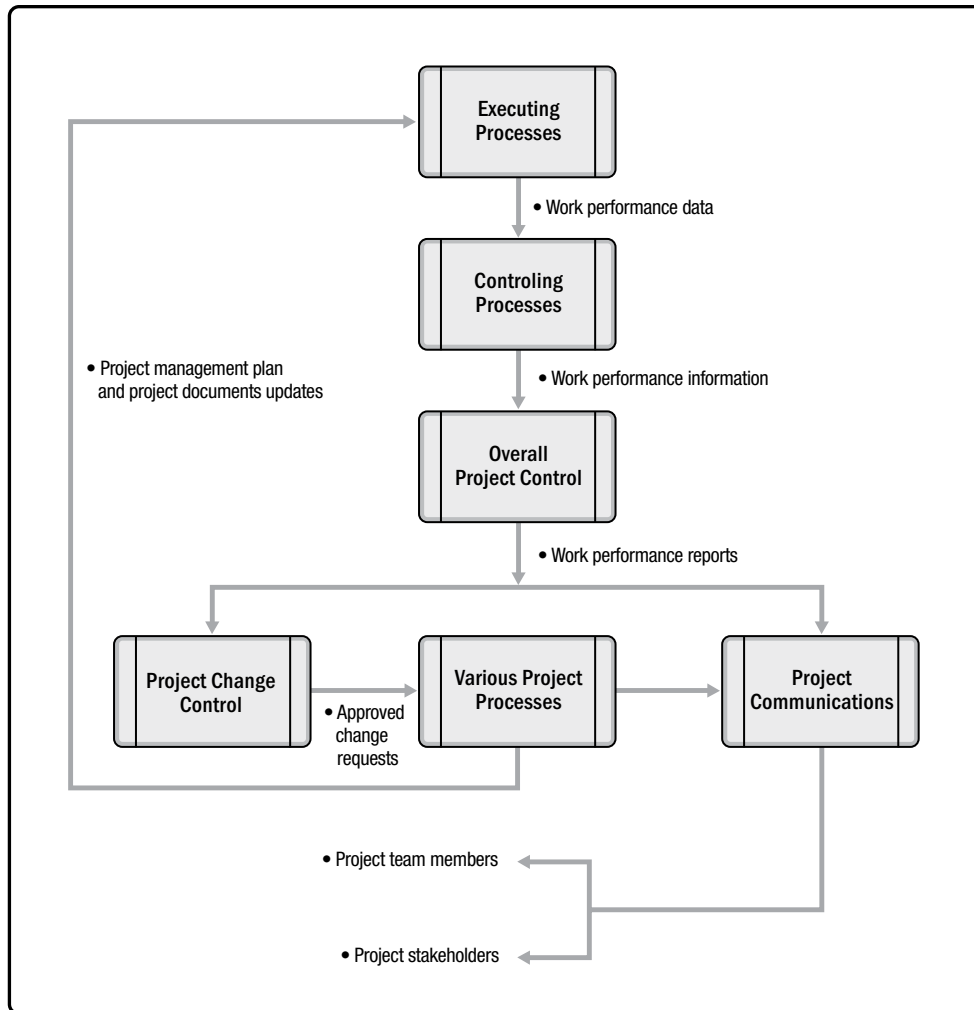

Figure 1-7. Project Data, Information, and Report Flow

1.2.5 TAILORING

Usually, project managers apply a project management methodology to their work. A methodology is a system of practices, techniques, procedures, and rules used by those who work in a discipline. This definition makes it clear that this guide itself is not a methodology.

This guide and *The Standard for Project Management* [1] are recommended references for tailoring, because these standard documents identify the subset of the project management body of knowledge that is generally recognized as good practice. “Good practice” does not mean that the knowledge described should always be applied uniformly to all projects. Specific methodology recommendations are outside the scope of this guide.

Project management methodologies may be:

- ◆ Developed by experts within the organization,
- ◆ Purchased from vendors,
- ◆ Obtained from professional associations, or
- ◆ Acquired from government agencies.

The appropriate project management processes, inputs, tools, techniques, outputs, and life cycle phases should be selected to manage a project. This selection activity is known as tailoring project management to the project. The project manager collaborates with the project team, sponsor, organizational management, or some combination thereof, in the tailoring. In some cases, the organization may require specific project management methodologies be used.

Tailoring is necessary because each project is unique; not every process, tool, technique, input, or output identified in the *PMBOK® Guide* is required on every project. Tailoring should address the competing constraints of scope, schedule, cost, resources, quality, and risk. The importance of each constraint is different for each project, and the project manager tailors the approach for managing these constraints based on the project environment, organizational culture, stakeholder needs, and other variables.

In tailoring project management, the project manager should also consider the varying levels of governance that may be required and within which the project will operate, as well as considering the culture of the organization. In addition, consideration of whether the customer of the project is internal or external to the organization may affect project management tailoring decisions.

Sound project management methodologies take into account the unique nature of projects and allow tailoring, to some extent, by the project manager. However, the tailoring that is included in the methodology may still require additional tailoring for a given project.

1.2.6 PROJECT MANAGEMENT BUSINESS DOCUMENTS

The project manager needs to ensure that the project management approach captures the intent of business documents. These documents are defined in Table 1-5. These two documents are interdependent and iteratively developed and maintained throughout the life cycle of the project.

Table 1-5. Project Business Documents

Project Business Documents	Definition
Project business case	A documented economic feasibility study used to establish the validity of the benefits of a selected component lacking sufficient definition and that is used as a basis for the authorization of further project management activities.
Project benefits management plan	The documented explanation defining the processes for creating, maximizing, and sustaining the benefits provided by a project.

The project sponsor is generally accountable for the development and maintenance of the project business case document. The project manager is responsible for providing recommendations and oversight to keep the project business case, project management plan, project charter, and project benefits management plan success measures in alignment with one another and with the goals and objectives of the organization.

Project managers should appropriately tailor the noted project management documents for their projects. In some organizations, the business case and benefits management plan are maintained at the program level. Project managers should work with the appropriate program managers to ensure the project management documents are aligned with the program documents. Figure 1-8 illustrates the interrelationship of these critical project management business documents and the needs assessment. Figure 1-8 shows an approximation of the life cycle of these various documents against the project life cycle.



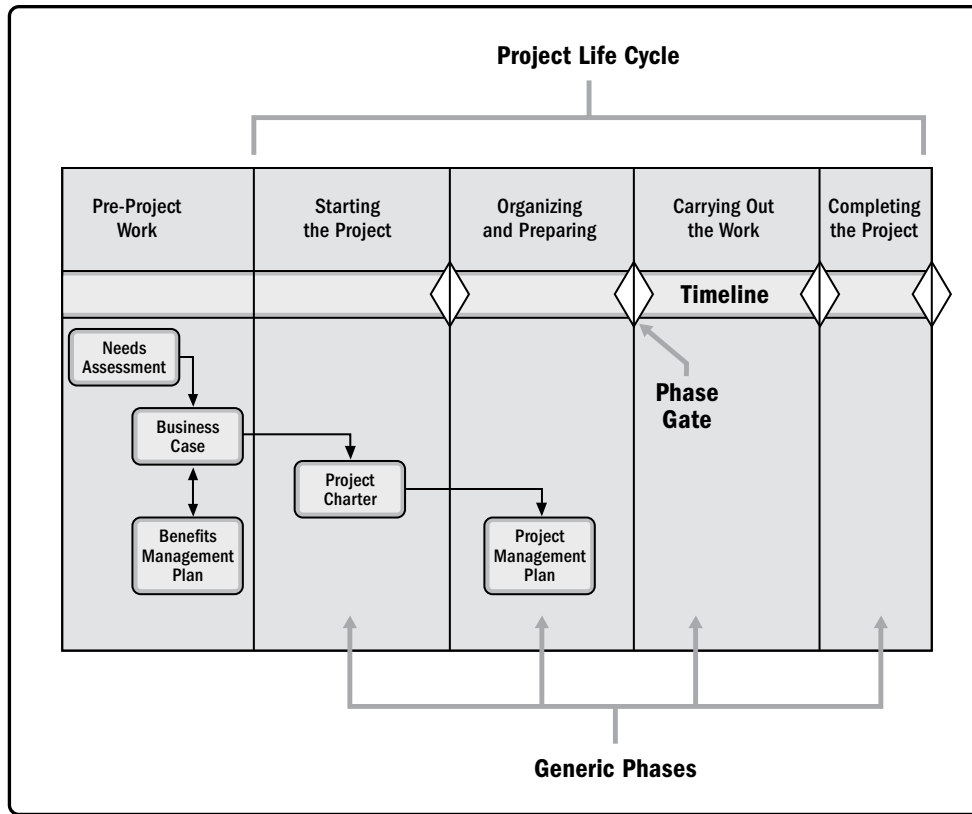

Figure 1-8. Interrelationship of Needs Assessment and Critical Business/Project Documents

1.2.6.1 PROJECT BUSINESS CASE

The project business case is a documented economic feasibility study used to establish the validity of the benefits of a selected component lacking sufficient definition and that is used as a basis for the authorization of further project management activities. The business case lists the objectives and reasons for project initiation. It helps measure the project success at the end of the project against the project objectives. The business case is a project business document that is used throughout the project life cycle. The business case may be used before the project initiation and may result in a go/no-go decision for the project.

A needs assessment often precedes the business case. The needs assessment involves understanding business goals and objectives, issues, and opportunities and recommending proposals to address them. The results of the needs assessment may be summarized in the business case document.

The process of defining the business need, analyzing the situation, making recommendations, and defining evaluation criteria is applicable to any organization's projects. A business case may include but is not limited to documenting the following:

- ◆ Business needs:
 - Determination of what is prompting the need for action;
 - Situational statement documenting the business problem or opportunity to be addressed including the value to be delivered to the organization;
 - Identification of stakeholders affected; and
 - Identification of the scope.
- ◆ Analysis of the situation:
 - Identification of organizational strategies, goals, and objectives;
 - Identification of root cause(s) of the problem or main contributors of an opportunity;
 - Gap analysis of capabilities needed for the project versus existing capabilities of the organization;
 - Identification of known risks;
 - Identification of critical success factors;
 - Identification of decision criteria by which the various courses of action may be assessed;

Examples of criteria categories used for analysis of a situation are:

- *Required.* This is a criterion that is “required” to be fulfilled to address the problem or opportunity.
- *Desired.* This is a criterion that is “desired” to be fulfilled to address the problem or opportunity.
- *Optional.* This is a criterion that is not essential. Fulfillment of this criterion may become a differentiator between alternative courses of action.
- Identification of a set of options to be considered for addressing the business problem or opportunity. Options are alternative courses of action that may be taken by the organization. Options may also be described as business scenarios. For example, a business case could present the following three options:
 - *Do nothing.* This is also referred to as the “business as usual” option. Selection of this option results in the project not being authorized.
 - *Do the minimum work possible to address the problem or opportunity.* The minimum may be established by identifying the set of documented criteria that are key in addressing the problem or opportunity.
 - *Do more than the minimum work possible to address the problem or opportunity.* This option meets the minimum set of criteria and some or all of the other documented criteria. There may be more than one of these options documented in the business case.

◆ Recommendation:

- A statement of the recommended option to pursue in the project;
- Items to include in the statement may include but are not limited to:
 - Analysis results for the potential option;
 - Constraints, assumptions, risks, and dependencies for the potential options;
and
 - Success measures (see Section 1.2.6.4).
- An implementation approach that may include but is not limited to:
 - Milestones,
 - Dependencies, and
 - Roles and responsibilities.

◆ Evaluation:

- Statement describing the plan for measuring benefits the project will deliver. This should include any ongoing operational aspects of the recommended option beyond initial implementation.

The business case document provides the basis to measure success and progress throughout the project life cycle by comparing the results with the objectives and the identified success criteria. See *Business Analysis for Practitioners: A Practice Guide* [7].

1.2.6.2 PROJECT BENEFITS MANAGEMENT PLAN

The project benefits management plan is the document that describes how and when the benefits of the project will be delivered, and describes the mechanisms that should be in place to measure those benefits. A project benefit is defined as an outcome of actions, behaviors, products, services, or results that provide value to the sponsoring organization as well as to the project's intended beneficiaries. Development of the benefits management plan begins early in the project life cycle with the definition of the target benefits to be realized. The benefits management plan describes key elements of the benefits and may include but is not limited to documenting the following:

- ◆ **Target benefits** (e.g., the expected tangible and intangible value to be gained by the implementation of the project; financial value is expressed as net present value);
- ◆ **Strategic alignment** (e.g., how well the project benefits align to the business strategies of the organization);
- ◆ **Timeframe for realizing benefits** (e.g., benefits by phase, short-term, long-term, and ongoing);
- ◆ **Benefits owner** (e.g., the accountable person to monitor, record, and report realized benefits throughout the timeframe established in the plan);
- ◆ **Metrics** (e.g., the measures to be used to show benefits realized, direct measures, and indirect measures);
- ◆ **Assumptions** (e.g., factors expected to be in place or to be in evidence); and
- ◆ **Risks** (e.g., risks for realization of benefits).

Developing the benefits management plan makes use of the data and information documented in the business case and needs assessment. For example, the cost-benefit analyses recorded in the documents illustrate the estimate of costs compared to the value of the benefits realized by the project. The benefits management plan and the project management plan include a description of how the business value resulting from the project becomes part of the organization's ongoing operations, including the metrics to be used. The metrics provide verification of the business value and validation of the project's success.

Development and maintenance of the project benefits management plan is an iterative activity. This document complements the business case, project charter, and project management plan. The project manager works with the sponsor to ensure that the project charter, project management plan, and the benefits management plan remain in alignment throughout the life cycle of the project. See *Business Analysis for Practitioners: A Practice Guide* [7], *The Standard for Program Management* [3], and *The Standard for Portfolio Management* [2].

1.2.6.3 PROJECT CHARTER AND PROJECT MANAGEMENT PLAN

The project charter is defined as a document issued by the project sponsor that formally authorizes the existence of a project and provides the project manager with the authority to apply organizational resources to project activities.

The project management plan is defined as the document that describes how the project will be executed, monitored, and controlled.

See Section 4 on Project Integration Management for more information on the project charter and the project management plan.

1.2.6.4 PROJECT SUCCESS MEASURES

One of the most common challenges in project management is determining whether or not a project is successful.

Traditionally, the project management metrics of time, cost, scope, and quality have been the most important factors in defining the success of a project. More recently, practitioners and scholars have determined that project success should also be measured with consideration toward achievement of the project objectives.

Project stakeholders may have different ideas as to what the successful completion of a project will look like and which factors are the most important. It is critical to clearly document the project objectives and to select objectives that are measurable. Three questions that the key stakeholders and the project manager should answer are:

- ◆ What does success look like for this project?
- ◆ How will success be measured?
- ◆ What factors may impact success?

The answer to these questions should be documented and agreed upon by the key stakeholders and the project manager.

Project success may include additional criteria linked to the organizational strategy and to the delivery of business results. These project objectives may include but are not limited to:

- ◆ Completing the project benefits management plan;
- ◆ Meeting the agreed-upon financial measures documented in the business case. These financial measures may include but are not limited to:
 - Net present value (NPV),
 - Return on investment (ROI),
 - Internal rate of return (IRR),
 - Payback period (PBP), and
 - Benefit-cost ratio (BCR).

- ◆ Meeting business case nonfinancial objectives;
- ◆ Completing movement of an organization from its current state to the desired future state;
- ◆ Fulfilling contract terms and conditions;
- ◆ Meeting organizational strategy, goals, and objectives;
- ◆ Achieving stakeholder satisfaction;
- ◆ Acceptable customer/end-user adoption;
- ◆ Integration of deliverables into the organization's operating environment;
- ◆ Achieving agreed-upon quality of delivery;
- ◆ Meeting governance criteria; and
- ◆ Achieving other agreed-upon success measures or criteria (e.g., process throughput).

The project team needs to be able to assess the project situation, balance the demands, and maintain proactive communication with stakeholders in order to deliver a successful project.

When the business alignment for a project is constant, the chance for project success greatly increases because the project remains aligned with the strategic direction of the organization.

It is possible for a project to be successful from a scope/schedule/budget viewpoint, and to be unsuccessful from a business viewpoint. This can occur when there is a change in the business needs or the market environment before the project is completed.





2

THE ENVIRONMENT IN WHICH PROJECTS OPERATE

2.1 OVERVIEW

Projects exist and operate in environments that may have an influence on them. These influences can have a favorable or unfavorable impact on the project. Two major categories of influences are enterprise environmental factors (EEFs) and organizational process assets (OPAs).

EEFs originate from the environment outside of the project and often outside of the enterprise. EEFs may have an impact at the organizational, portfolio, program, or project level. See Section 2.2 for additional information on EEFs.

OPAs are internal to the organization. These may arise from the organization itself, a portfolio, a program, another project, or a combination of these. Figure 2-1 shows the breakdown of project influences into EEFs and OPAs. See Section 2.3 for additional information on OPAs.

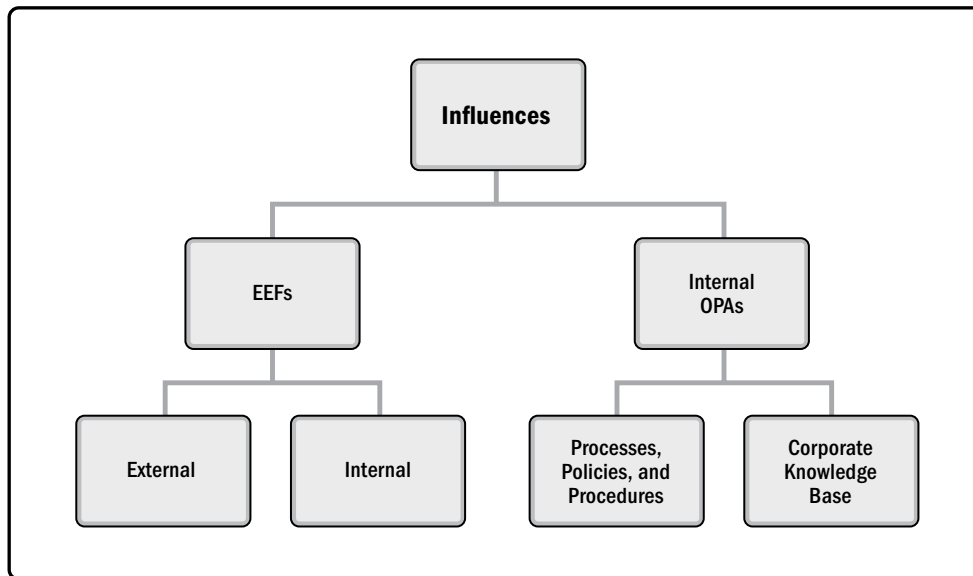

Figure 2-1. Project Influences

In addition to EEFs and OPAs, organizational systems play a significant role in the life cycle of the project. System factors that impact the power, influence, interests, competencies, and political capabilities of the people to act within the organizational system are discussed further in the section on organizational systems (see Section 2.4).

2.2 ENTERPRISE ENVIRONMENTAL FACTORS

Enterprise environmental factors (EEFs) refer to conditions, not under the control of the project team, that influence, constrain, or direct the project. These conditions can be internal and/or external to the organization. EEFs are considered as inputs to many project management processes, specifically for most planning processes. These factors may enhance or constrain project management options. In addition, these factors may have a positive or negative influence on the outcome.

EEFs vary widely in type or nature. These factors need to be considered if the project is to be effective. EEFs include but are not limited to the factors described in Sections 2.2.1 and 2.2.2.

2.2.1 EEFS INTERNAL TO THE ORGANIZATION

The following EEFs are internal to the organization:

- ◆ **Organizational culture, structure, and governance.** Examples include vision, mission, values, beliefs, cultural norms, leadership style, hierarchy and authority relationships, organizational style, ethics, and code of conduct.
- ◆ **Geographic distribution of facilities and resources.** Examples include factory locations, virtual teams, shared systems, and cloud computing.
- ◆ **Infrastructure.** Examples include existing facilities, equipment, organizational telecommunications channels, information technology hardware, availability, and capacity.
- ◆ **Information technology software.** Examples include scheduling software tools, configuration management systems, web interfaces to other online automated systems, and work authorization systems.
- ◆ **Resource availability.** Examples include contracting and purchasing constraints, approved providers and subcontractors, and collaboration agreements.
- ◆ **Employee capability.** Examples include existing human resources expertise, skills, competencies, and specialized knowledge.

2.2.2 EEFS EXTERNAL TO THE ORGANIZATION

The following EEFS are external to the organization.

- ◆ **Marketplace conditions.** Examples include competitors, market share brand recognition, and trademarks.
- ◆ **Social and cultural influences and issues.** Examples include political climate, codes of conduct, ethics, and perceptions.
- ◆ **Legal restrictions.** Examples include country or local laws and regulations related to security, data protection, business conduct, employment, and procurement.
- ◆ **Commercial databases.** Examples include benchmarking results, standardized cost estimating data, industry risk study information, and risk databases.
- ◆ **Academic research.** Examples include industry studies, publications, and benchmarking results.
- ◆ **Government or industry standards.** Examples include regulatory agency regulations and standards related to products, production, environment, quality, and workmanship.
- ◆ **Financial considerations.** Examples include currency exchange rates, interest rates, inflation rates, tariffs, and geographic location.
- ◆ **Physical environmental elements.** Examples include working conditions, weather, and constraints.

2.3 ORGANIZATIONAL PROCESS ASSETS

Organizational process assets (OPAs) are the plans, processes, policies, procedures, and knowledge bases specific to and used by the performing organization. These assets influence the management of the project.

OPAs include any artifact, practice, or knowledge from any or all of the performing organizations involved in the project that can be used to execute or govern the project. The OPAs also include the organization's lessons learned from previous projects and historical information. OPAs may include completed schedules, risk data, and earned value data. OPAs are inputs to many project management processes. Since OPAs are internal to the organization, the project team members may be able to update and add to the organizational process assets as necessary throughout the project. They may be grouped into two categories:

- ◆ Processes, policies, and procedures; and
- ◆ Organizational knowledge bases.

Generally, the assets in the first category are not updated as part of the project work. Processes, policies, and procedures are usually established by the project management office (PMO) or another function outside of the project. These can be updated only by following the appropriate organizational policies associated with updating processes, policies, or procedures. Some organizations encourage the team to tailor templates, life cycles, and checklists for the project. In these instances, the project management team should tailor those assets to meet the needs of the project.

The assets in the second category are updated throughout the project with project information. For example, information on financial performance, lessons learned, performance metrics and issues, and defects are continually updated throughout the project.

2.3.1 PROCESSES, POLICIES, AND PROCEDURES

The organization's processes and procedures for conducting project work include but are not limited to:

◆ **Initiating and Planning:**

- Guidelines and criteria for tailoring the organization's set of standard processes and procedures to satisfy the specific needs of the project;
- Specific organizational standards such as policies (e.g., human resources policies, health and safety policies, security and confidentiality policies, quality policies, procurement policies, and environmental policies);
- Product and project life cycles, and methods and procedures (e.g., project management methods, estimation metrics, process audits, improvement targets, checklists, and standardized process definitions for use in the organization);
- Templates (e.g., project management plans, project documents, project registers, report formats, contract templates, risk categories, risk statement templates, probability and impact definitions, probability and impact matrices, and stakeholder register templates); and
- Preapproved supplier lists and various types of contractual agreements (e.g., fixed-price, cost-reimbursable, and time and material contracts).

◆ **Executing, Monitoring, and Controlling:**

- Change control procedures, including the steps by which performing organization standards, policies, plans, and procedures or any project documents will be modified, and how any changes will be approved and validated;
- Traceability matrices;
- Financial controls procedures (e.g., time reporting, required expenditure and disbursement reviews, accounting codes, and standard contract provisions);

- Issue and defect management procedures (e.g., defining issue and defect controls, identifying and resolving issues and defects, and tracking action items);
 - Resource availability control and assignment management;
 - Organizational communication requirements (e.g., specific communication technology available, authorized communication media, record retention policies, videoconferencing, collaborative tools, and security requirements);
 - Procedures for prioritizing, approving, and issuing work authorizations;
 - Templates (e.g., risk register, issue log, and change log);
 - Standardized guidelines, work instructions, proposal evaluation criteria, and performance measurement criteria; and
 - Product, service, or result verification and validation procedures.
- ◆ **Closing.** Project closure guidelines or requirements (e.g., final project audits, project evaluations, deliverable acceptance, contract closure, resource reassignment, and knowledge transfer to production and/or operations).

2.3.2 ORGANIZATIONAL KNOWLEDGE REPOSITORIES

The organizational knowledge repositories for storing and retrieving information include but are not limited to:

- ◆ Configuration management knowledge repositories containing the versions of software and hardware components and baselines of all performing organization standards, policies, procedures, and any project documents;
- ◆ Financial data repositories containing information such as labor hours, incurred costs, budgets, and any project cost overruns;
- ◆ Historical information and lessons learned knowledge repositories (e.g., project records and documents, all project closure information and documentation, information regarding both the results of previous project selection decisions and previous project performance information, and information from risk management activities);
- ◆ Issue and defect management data repositories containing issue and defect status, control information, issue and defect resolution, and action item results;
- ◆ Data repositories for metrics used to collect and make available measurement data on processes and products; and
- ◆ Project files from previous projects (e.g., scope, cost, schedule, and performance measurement baselines, project calendars, project schedule network diagrams, risk registers, risk reports, and stakeholder registers).

2.4 ORGANIZATIONAL SYSTEMS

2.4.1 OVERVIEW

Projects operate within the constraints imposed by the organization through their structure and governance framework. To operate effectively and efficiently, the project manager needs to understand where responsibility, accountability, and authority reside within the organization. This understanding will help the project manager effectively use his or her power, influence, competence, leadership, and political capabilities to successfully complete the project.

The interaction of multiple factors within an individual organization creates a unique system that impacts the project operating in that system. The resulting organizational system determines the power, influence, interests, competence, and political capabilities of the people who are able to act within the system. The system factors include but are not limited to:

- ◆ Management elements,
- ◆ Governance frameworks, and
- ◆ Organizational structure types.

The complete information and explanation of the organizational system factors and how the combination of these factors impacts a project are beyond the scope of this guide. There are disciplines with associated literature, methodologies, and practices that address these factors in more depth than is possible within this guide. This section provides an overview of these factors and their interrelationship.

This overview begins by discussing systems in general. A system is a collection of various components that together can produce results not obtainable by the individual components alone. A component is an identifiable element within the project or organization that provides a particular function or group of related functions. The interaction of the various system components creates the organizational culture and capabilities. There are several principles regarding systems:

- ◆ Systems are dynamic,
- ◆ Systems can be optimized,
- ◆ System components can be optimized,
- ◆ Systems and their components cannot be optimized at the same time, and
- ◆ Systems are nonlinear in responsiveness (a change in the input does not produce a predictable change in the output).

Multiple changes may occur within the system and between the system and its environment. When these changes take place, adaptive behavior occurs within the components that in turn add to the system's dynamics. The system's dynamics are defined by the interaction between the components based on the relationships and dependencies that exist between the components.

Systems are typically the responsibility of an organization's management. The organization's management examines the optimization trade-offs between the components and the system in order to take the appropriate action to achieve the best outcomes for the organization. The results of this examination will impact the project under consideration. Therefore, it is important that the project manager take these results into account when determining how to fulfill the project's objectives. In addition, the project manager should take into account the organization's governance framework.

2.4.2 ORGANIZATIONAL GOVERNANCE FRAMEWORKS

Recent PMI research reveals that governance refers to organizational or structural arrangements at all levels of an organization designed to determine and influence the behavior of the organization's members [9]. This research suggests that the concept of governance is multidimensional and:

- ◆ Includes consideration of people, roles, structures, and policies; and
- ◆ Requires providing direction and oversight through data and feedback.

2.4.2.1 GOVERNANCE FRAMEWORK

Governance is the framework within which authority is exercised in organizations. This framework includes but is not limited to:

- ◆ Rules,
- ◆ Policies,
- ◆ Procedures,
- ◆ Norms,
- ◆ Relationships,
- ◆ Systems, and
- ◆ Processes.

This framework influences how:

- ◆ Objectives of the organization are set and achieved,
- ◆ Risk is monitored and assessed, and
- ◆ Performance is optimized.

2.4.2.2 GOVERNANCE OF PORTFOLIOS, PROGRAMS, AND PROJECTS

The *Governance of Portfolios, Programs, and Projects: A Practice Guide* [10] describes a common governance framework aligning organizational project management (OPM) and portfolio, program, and project management. The practice guide describes four governance domains of alignment, risk, performance, and communications. Each domain has the following functions: oversight, control, integration, and decision making. Each function has governance supporting processes and activities for stand-alone projects, or projects operating within the portfolio or program environments.

Project governance refers to the framework, functions, and processes that guide project management activities in order to create a unique product, service, or result to meet organizational, strategic, and operational goals. There is no one governance framework that is effective in all organizations. A governance framework should be tailored to the organizational culture, types of projects, and the needs of the organization in order to be effective.

For more information regarding project governance, including its implementation, see *Governance of Portfolios, Programs, and Projects: A Practice Guide* [10].

2.4.3 MANAGEMENT ELEMENTS

Management elements are the components that comprise the key functions or principles of general management in the organization. The general management elements are allocated within the organization according to its governance framework and the organizational structure type selected.

The key functions or principles of management include but are not limited to:

- ◆ Division of work using specialized skills and availability to perform work;
- ◆ Authority given to perform work;
- ◆ Responsibility to perform work appropriately assigned based on such attributes as skill and experience;
- ◆ Discipline of action (e.g., respect for authority, people, and rules);
- ◆ Unity of command (e.g., only one person gives orders for any action or activity to an individual);
- ◆ Unity of direction (e.g., one plan and one head for a group of activities with the same objective);
- ◆ General goals of the organization take precedence over individual goals;
- ◆ Paid fairly for work performed;

- ◆ Optimal use of resources;
- ◆ Clear communication channels;
- ◆ Right materials to the right person for the right job at the right time;
- ◆ Fair and equal treatment of people in the workplace;
- ◆ Clear security of work positions;
- ◆ Safety of people in the workplace;
- ◆ Open contribution to planning and execution by each person; and
- ◆ Optimal morale.

Performance of these management elements are assigned to selected individuals within the organization. These individuals may perform the noted functions within various organizational structures. For example, in a hierarchical structure, there are horizontal and vertical levels within the organization. These hierarchical levels range from the line management level through to the executive management level. The responsibility, accountability, and authority assigned to the hierarchical level indicate how the individual may perform the noted function within that organizational structure.

2.4.4 ORGANIZATIONAL STRUCTURE TYPES

Determination of the appropriate organizational structure type is a result of the study of tradeoffs between two key variables. The variables are the organizational structure types available for use and how to optimize them for a given organization. There is not a one-size-fits-all structure for any given organization. The final structure for a given organization is unique due to the numerous variables to be considered. Sections 2.4.4.1 and 2.4.4.2 give examples of some of the factors to be included when considering the two variables given. Section 2.4.4.3 discusses one organizational structure that is prevalent in project management.

2.4.4.1 ORGANIZATIONAL STRUCTURE TYPES

Organizational structures take many forms or types. Table 2-1 compares several types of organizational structures and their influence on projects.

2.4.4.2 FACTORS IN ORGANIZATION STRUCTURE SELECTION

Each organization considers numerous factors for inclusion in its organizational structure. Each factor may carry a different level of importance in the final analysis. The combination of the factor, its value, and relative importance provides the organization's decision makers with the right information for inclusion in the analysis.

Factors to consider in selecting an organizational structure include but are not limited to:

- ◆ Degree of alignment with organizational objectives,
- ◆ Specialization capabilities,
- ◆ Span of control, efficiency, and effectiveness,
- ◆ Clear path for escalation of decisions,
- ◆ Clear line and scope of authority,
- ◆ Delegation capabilities,
- ◆ Accountability assignment,
- ◆ Responsibility assignment,
- ◆ Adaptability of design,
- ◆ Simplicity of design,
- ◆ Efficiency of performance,
- ◆ Cost considerations,
- ◆ Physical locations (e.g., colocated, regional, and virtual), and
- ◆ Clear communication (e.g., policies, status of work, and organization's vision).



Table 2-1. Influences of Organizational Structures on Projects

Organizational Structure Type	Project Characteristics					
	Work Groups Arranged by:	Project Manager's Authority	Project Manager's Role	Resource Availability	Who Manages the Project Budget?	Project Management Administrative Staff
Organic or Simple	Flexible; people working side-by-side	Little or none	Part-time; may or may not be a designated job role like coordinator	Little or none	Owner or operator	Little or none
Functional (centralized)	Job being done (e.g., engineering, manufacturing)	Little or none	Part-time; may or may not be a designated job role like coordinator	Little or none	Functional manager	Part-time
Multi-divisional (may replicate functions for each division with little centralization)	One of: product; production processes; portfolio; program; geographic region; customer type	Little or none	Part-time; may or may not be a designated job role like coordinator	Little or none	Functional manager	Part-time
Matrix – strong	By job function, with project manager as a function	Moderate to high	Full-time designated job role	Moderate to high	Project manager	Full-time
Matrix – weak	Job function	Low	Part-time; done as part of another job and not a designated job role like coordinator	Low	Functional manager	Part-time
Matrix – balanced	Job function	Low to moderate	Part-time; embedded in the functions as a skill and may not be a designated job role like coordinator	Low to moderate	Mixed	Part-time
Project-oriented (composite, hybrid)	Project	High to almost total	Full-time designated job role	High to almost total	Project manager	Full-time
Virtual	Network structure with nodes at points of contact with other people	Low to moderate	Full-time or part-time	Low to moderate	Mixed	Could be full-time or part-time
Hybrid	Mix of other types	Mixed	Mixed	Mixed	Mixed	Mixed
PMO*	Mix of other types	High to almost total	Full-time designated job role	High to almost total	Project manager	Full-time

*PMO refers to a portfolio, program, or project management office or organization.

2.4.4.3 PROJECT MANAGEMENT OFFICE

A project management office (PMO) is an organizational structure that standardizes the project-related governance processes and facilitates the sharing of resources, methodologies, tools, and techniques. The responsibilities of a PMO can range from providing project management support functions to the direct management of one or more projects.

There are several types of PMOs in organizations. Each type varies in the degree of control and influence it has on projects within the organization, such as:

- ◆ **Supportive.** Supportive PMOs provide a consultative role to projects by supplying templates, best practices, training, access to information, and lessons learned from other projects. This type of PMO serves as a project repository. The degree of control provided by the PMO is low.
- ◆ **Controlling.** Controlling PMOs provide support and require compliance through various means. The degree of control provided by the PMO is moderate. Compliance may involve:
 - Adoption of project management frameworks or methodologies;
 - Use of specific templates, forms, and tools; and
 - Conformance to governance frameworks.
- ◆ **Directive.** Directive PMOs take control of the projects by directly managing the projects. Project managers are assigned by and report to the PMO. The degree of control provided by the PMO is high.

The project management office may have organization-wide responsibility. It may play a role in supporting strategic alignment and delivering organizational value. The PMO integrates data and information from organizational strategic projects and evaluates how higher-level strategic objectives are being fulfilled. The PMO is the natural liaison between the organization's portfolios, programs, projects, and the organizational measurement systems (e.g., balanced scorecard).

The projects supported or administered by the PMO may not be related other than by being managed together. The specific form, function, and structure of a PMO are dependent upon the needs of the organization that it supports.

A PMO may have the authority to act as an integral stakeholder and a key decision maker throughout the life of each project in order to keep it aligned with the business objectives. The PMO may:

- ◆ Make recommendations,
- ◆ Lead knowledge transfer,
- ◆ Terminate projects, and
- ◆ Take other actions, as required.

A primary function of a PMO is to support project managers in a variety of ways, which may include but are not limited to:

- ◆ Managing shared resources across all projects administered by the PMO;
- ◆ Identifying and developing project management methodology, best practices, and standards;
- ◆ Coaching, mentoring, training, and oversight;
- ◆ Monitoring compliance with project management standards, policies, procedures, and templates by means of project audits;
- ◆ Developing and managing project policies, procedures, templates, and other shared documentation (organizational process assets); and
- ◆ Coordinating communication across projects.





3

THE ROLE OF THE PROJECT MANAGER

3.1 OVERVIEW

The project manager plays a critical role in the leadership of a project team in order to achieve the project's objectives. This role is clearly visible throughout the project. Many project managers become involved in a project from its initiation through closing. However, in some organizations, a project manager may be involved in evaluation and analysis activities prior to project initiation. These activities may include consulting with executive and business unit leaders on ideas for advancing strategic objectives, improving organizational performance, or meeting customer needs. In some organizational settings, the project manager may also be called upon to manage or assist in business analysis, business case development, and aspects of portfolio management for a project. A project manager may also be involved in follow-on activities related to realizing business benefits from the project. The role of a project manager may vary from organization to organization. Ultimately, the project management role is tailored to fit the organization in the same way that the project management processes are tailored to fit the project.

A simple analogy may help in understanding the roles of a project manager for a large project by comparing them to the roles of a conductor for a large orchestra:

- ◆ **Membership and roles.** A large project and an orchestra each comprise many members, each playing a different role. A large orchestra may have more than 100 musicians who are led by a conductor. These musicians may play 25 different kinds of instruments placed into major sections, such as strings, woodwinds, brass, and percussion. Similarly, a large project may have more than 100 project members led by a project manager. Team members may fulfill many different roles, such as design, manufacturing, and facilities management. Like the major sections of the orchestra, they represent multiple business units or groups within an organization. The musicians and the project members make up each leader's team.
- ◆ **Responsibility for team.** The project manager and conductor are both responsible for what their teams produce—the project outcome or the orchestra concert, respectively. The two leaders need to take a holistic view of their team's products in order to plan, coordinate, and complete them. The two leaders begin by reviewing the vision, mission, and objectives of their respective organizations to ensure alignment with their products. The two leaders establish their interpretation of the vision, mission, and objectives involved in successfully completing their products. The leaders use their interpretation to communicate and motivate their teams toward the successful completion of their objectives.

◆ **Knowledge and skills:**

- The conductor is not expected to be able to play every instrument in the orchestra, but should possess musical knowledge, understanding, and experience. The conductor provides the orchestra with leadership, planning, and coordination through communications. The conductor provides written communication in the form of musical scores and practice schedules. The conductor also communicates in real time with the team by using a baton and other body movements.
- The project manager is not expected to perform every role on the project, but should possess project management knowledge, technical knowledge, understanding, and experience. The project manager provides the project team with leadership, planning, and coordination through communications. The project manager provides written communications (e.g., documented plans and schedules) and communicates in real time with the team using meetings and verbal or nonverbal cues.

The remainder of this section covers the key aspects of the role of the project manager. While there are thousands of books and articles available on the subject, this section is not intended to cover the entire spectrum of information available. Rather, it is designed to present an overview that will provide the practitioner with a basic understanding of the subject in preparation for a more concentrated study on the various aspects discussed.

3.2 DEFINITION OF A PROJECT MANAGER

The role of a project manager is distinct from that of a functional manager or operations manager. Typically, the functional manager focuses on providing management oversight for a functional or business unit. Operations managers are responsible for ensuring that business operations are efficient. The project manager is the person assigned by the performing organization to lead the team that is responsible for achieving the project objectives.

3.3 THE PROJECT MANAGER'S SPHERE OF INFLUENCE

3.3.1 OVERVIEW

Project managers fulfill numerous roles within their sphere of influence. These roles reflect the project manager's capabilities and are representative of the value and contributions of the project management profession. This section highlights the roles of the project manager in the various spheres of influence shown in Figure 3-1.

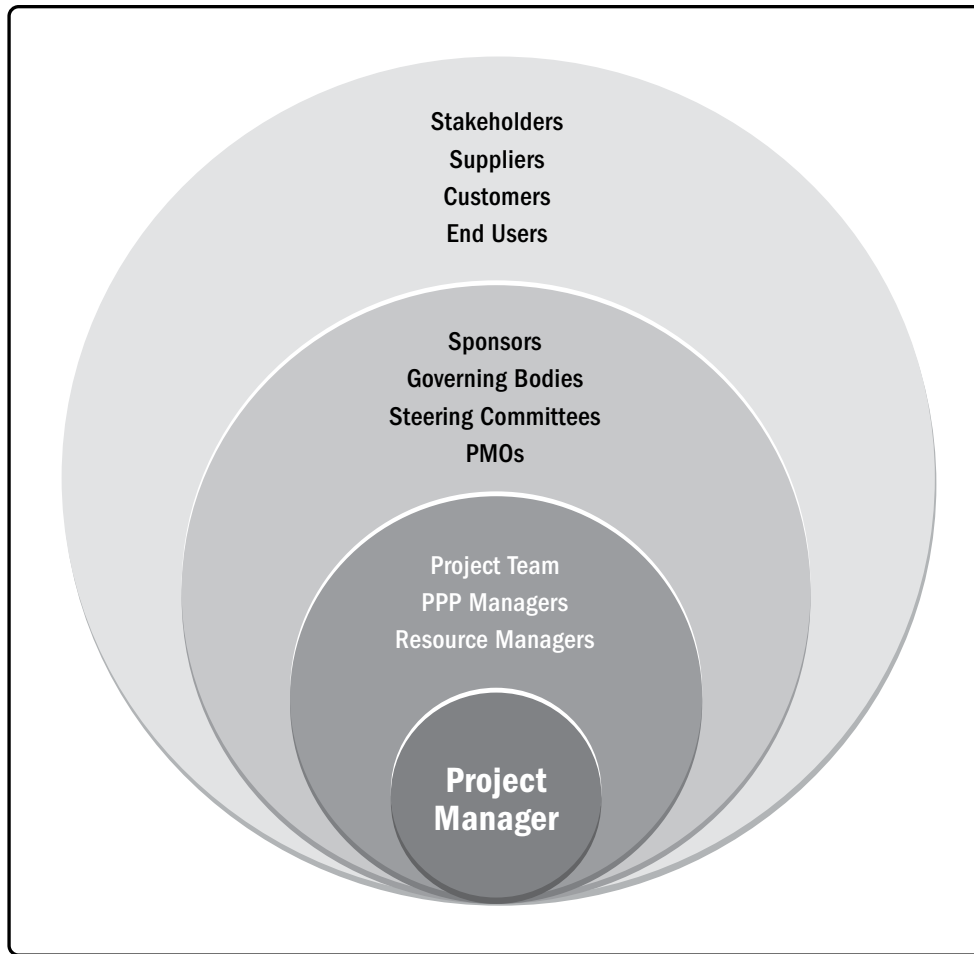

Figure 3-1. Example of Project Manager's Sphere of Influence

3.3.2 THE PROJECT

The project manager leads the project team to meet the project's objectives and stakeholders' expectations. The project manager works to balance the competing constraints on the project with the resources available.

The project manager also performs communication roles between the project sponsor, team members, and other stakeholders. This includes providing direction and presenting the vision of success for the project. The project manager uses soft skills (e.g., interpersonal skills and the ability to manage people) to balance the conflicting and competing goals of the project stakeholders in order to achieve consensus. In this context, consensus means that the relevant stakeholders support the project decisions and actions even when there is not 100% agreement.

Research shows that successful project managers consistently and effectively use certain essential skills. Research reveals that the top 2% of project managers as designated by their bosses and team members distinguish themselves by demonstrating superior relationship and communication skills while displaying a positive attitude [12].

The ability to communicate with stakeholders, including the team and sponsors applies across multiple aspects of the project including, but not limited to, the following:

- ◆ Developing finely tuned skills using multiple methods (e.g., verbal, written, and nonverbal);
- ◆ Creating, maintaining, and adhering to communications plans and schedules;
- ◆ Communicating predictably and consistently;
- ◆ Seeking to understand the project stakeholders' communication needs (communication may be the only deliverable that some stakeholders received until the project's end product or service is completed);
- ◆ Making communications concise, clear, complete, simple, relevant, and tailored;
- ◆ Including important positive and negative news;
- ◆ Incorporating feedback channels; and
- ◆ Relationship skills involving the development of extensive networks of people throughout the project manager's spheres of influence. These networks include formal networks such as organizational reporting structures. However, the informal networks that project managers develop, maintain, and nurture are more important. Informal networks include the use of established relationships with individuals such as subject matter experts and influential leaders. Use of these formal and informal networks allows the project manager to engage multiple people in solving problems and navigating the bureaucracies encountered in a project.

3.3.3 THE ORGANIZATION

The project manager proactively interacts with other project managers. Other independent projects or projects that are part of the same program may impact a project due to but not limited to the following:

- ◆ Demands on the same resources,
- ◆ Priorities of funding,
- ◆ Receipt or distribution of deliverables, and
- ◆ Alignment of project goals and objectives with those of the organization.

Interacting with other project managers helps to create a positive influence for fulfilling the various needs of the project. These needs may be in the form of human, technical, or financial resources and deliverables required by the team for project completion. The project manager seeks ways to develop relationships that assist the team in achieving the goals and objectives of the project.

In addition, the project manager maintains a strong advocacy role within the organization. The project manager proactively interacts with managers within the organization during the course of the project. The project manager also works with the project sponsor to address internal political and strategic issues that may impact the team or the viability or quality of the project.

The project manager may work toward increasing the project management competency and capability within the organization as a whole and is involved in both tacit and explicit knowledge transfer or integration initiatives (see Section 4.4 on Manage Project Knowledge). The project manager also works to:

- ◆ Demonstrate the value of project management,
- ◆ Increase acceptance of project management in the organization, and
- ◆ Advance the efficacy of the PMO when one exists in the organization.

Depending on the organizational structure, a project manager may report to a functional manager. In other cases, a project manager may be one of several project managers who report to a PMO or a portfolio or program manager who is ultimately responsible for one or more organization-wide projects. The project manager works closely with all relevant managers to achieve the project objectives and to ensure the project management plan aligns with the portfolio or program plan. The project manager also works closely and in collaboration with other roles, such as organizational managers, subject matter experts, and those involved with business analysis. In some situations, the project manager may be an external consultant placed in a temporary management role.

3.3.4 THE INDUSTRY

The project manager stays informed about current industry trends. The project manager takes this information and sees how it may impact or apply to the current projects. These trends include but are not limited to:

- ◆ Product and technology development;
- ◆ New and changing market niches;
- ◆ Standards (e.g., project management, quality management, information security management);
- ◆ Technical support tools;
- ◆ Economic forces that impact the immediate project;
- ◆ Influences affecting the project management discipline; and
- ◆ Process improvement and sustainability strategies.

3.3.5 PROFESSIONAL DISCIPLINE

Continuing knowledge transfer and integration is very important for the project manager. This professional development is ongoing in the project management profession and in other areas where the project manager maintains subject matter expertise. This knowledge transfer and integration includes but is not limited to:

- ◆ Contribution of knowledge and expertise to others within the profession at the local, national, and global levels (e.g., communities of practice, international organizations); and
- ◆ Participation in training, continuing education, and development:
 - In the project management profession (e.g., universities, PMI);
 - In a related profession (e.g., systems engineering, configuration management); and
 - In other professions (e.g., information technology, aerospace).

3.3.6 ACROSS DISCIPLINES

A professional project manager may choose to orient and educate other professionals regarding the value of a project management approach to the organization. The project manager may serve as an informal ambassador by educating the organization as to the advantages of project management with regard to timeliness, quality, innovation, and resource management.

3.4 PROJECT MANAGER COMPETENCES

3.4.1 OVERVIEW

Recent PMI studies applied the *Project Manager Competency Development (PMCD) Framework* to the skills needed by project managers through the use of The PMI Talent Triangle® shown in Figure 3-2. The talent triangle focuses on three key skill sets:

- ◆ **Technical project management.** The knowledge, skills, and behaviors related to specific domains of project, program, and portfolio management. The technical aspects of performing one's role.
- ◆ **Leadership.** The knowledge, skills, and behaviors needed to guide, motivate, and direct a team, to help an organization achieve its business goals.
- ◆ **Strategic and business management.** The knowledge of and expertise in the industry and organization that enhanced performance and better delivers business outcomes.

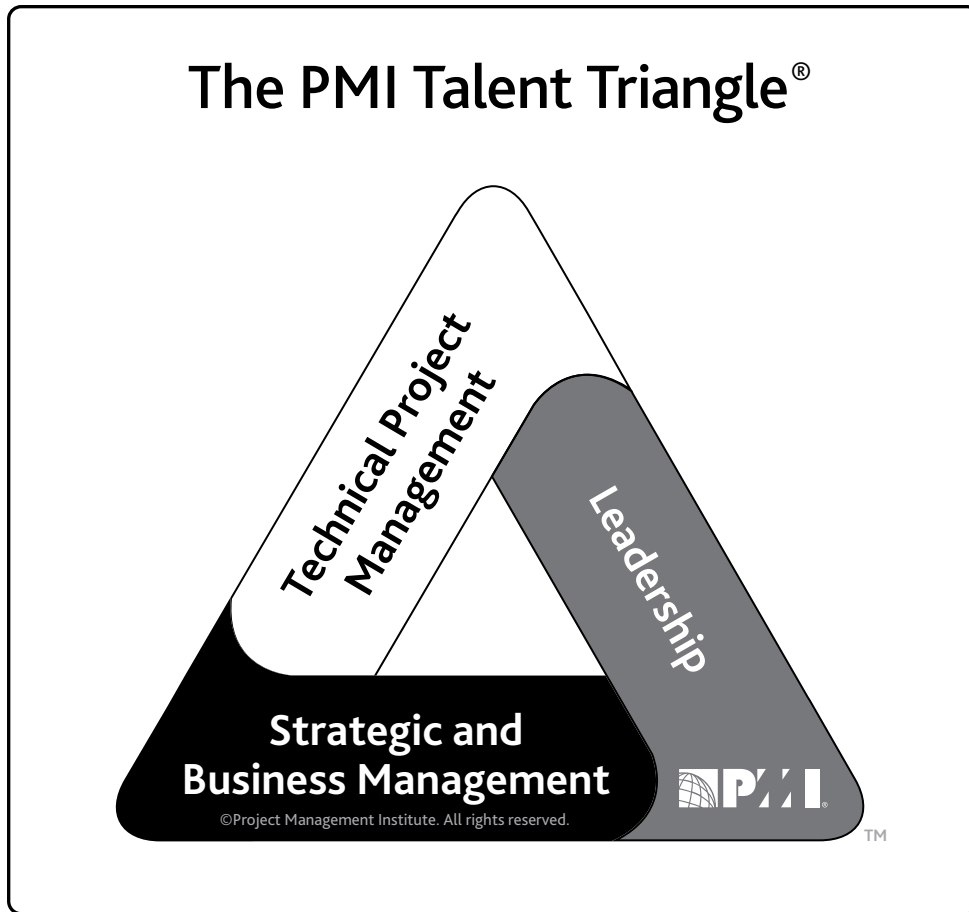

Figure 3-2. The PMI Talent Triangle®

While technical project management skills are core to program and project management, PMI research indicates that they are not enough in today's increasingly complicated and competitive global marketplace. Organizations are seeking added skills in leadership and business intelligence. Members of various organizations state their belief that these competencies can support longer-range strategic objectives that contribute to the bottom line. To be the most effective, project managers need to have a balance of these three skill sets.

3.4.2 TECHNICAL PROJECT MANAGEMENT SKILLS

Technical project management skills are defined as the skills to effectively apply project management knowledge to deliver the desired outcomes for programs or projects. There are numerous technical project management skills. The Knowledge Areas in this guide describe many of these necessary project management skills. Project managers frequently rely on expert judgment to perform well. Being aware of personal expertise and where to find others with the needed expertise are important for success as a project manager.

According to research, the top project managers consistently demonstrated several key skills including, but not limited to, the ability to:

- ◆ Focus on the critical technical project management elements for each project they manage. This focus is as simple as having the right artifacts readily available. At the top of the list were the following:
 - Critical success factors for the project,
 - Schedule,
 - Selected financial reports, and
 - Issue log.
- ◆ Tailor both traditional and agile tools, techniques, and methods for each project.
- ◆ Make time to plan thoroughly and prioritize diligently.
- ◆ Manage project elements, including, but not limited to, schedule, cost, resources, and risks.

3.4.3 STRATEGIC AND BUSINESS MANAGEMENT SKILLS

Strategic and business management skills involve the ability to see the high-level overview of the organization and effectively negotiate and implement decisions and actions that support strategic alignment and innovation. This ability may include a working knowledge of other functions such as finance, marketing, and operations. Strategic and business management skills may also include developing and applying pertinent product and industry expertise. This business knowledge is also known as domain knowledge. Project managers should be knowledgeable enough about the business to be able to:

- ◆ Explain to others the essential business aspects of a project;
- ◆ Work with the project sponsor, team, and subject matter experts to develop an appropriate project delivery strategy; and
- ◆ Implement that strategy in a way that maximizes the business value of the project.

In order to make the best decisions regarding the successful delivery of their projects, project managers should seek out and consider the expertise of the operational managers who run the business in their organization. These managers should know the work performed in their organization and how project plans will affect that work. The more the project manager is able to know about the project's subject matter, the better. At a minimum, the project manager should be knowledgeable enough to explain to others the following aspects of the organization:

- ◆ Strategy;
- ◆ Mission;
- ◆ Goals and objectives;
- ◆ Products and services;
- ◆ Operations (e.g., location, type, technology);
- ◆ The market and the market condition, such as customers, state of the market (i.e., growing or shrinking), and time-to-market factors, etc.; and
- ◆ Competition (e.g., what, who, position in the market place).

The project manager should apply the following knowledge and information about the organization to the project to ensure alignment:

- ◆ Strategy,
- ◆ Mission,
- ◆ Goals and objectives,
- ◆ Priority,
- ◆ Tactics, and
- ◆ Products or services (e.g., deliverables).



Strategic and business skills help the project manager to determine which business factors should be considered for their project. The project manager determines how these business and strategic factors could affect the project while understanding the interrelationship between the project and the organization. These factors include but are not limited to:

- ◆ Risks and issues,
- ◆ Financial implications,
- ◆ Cost versus benefits analysis (e.g., net present value, return on investment), including the various options considered,
- ◆ Business value,
- ◆ Benefits realization expectations and strategies, and
- ◆ Scope, budget, schedule, and quality.

Through the application of this business knowledge, a project manager has the ability to make the appropriate decisions and recommendations for a project. As conditions change, the project manager should be continuously working with the project sponsor to keep the business and the project strategies aligned.

3.4.4 LEADERSHIP SKILLS

Leadership skills involve the ability to guide, motivate, and direct a team. These skills may include demonstrating essential capabilities such as negotiation, resilience, communication, problem solving, critical thinking, and interpersonal skills. Projects are becoming increasingly more complicated with more and more businesses executing their strategy through projects. Project management is more than just working with numbers, templates, charts, graphs, and computing systems. A common denominator in all projects is people. People can be counted, but they are not numbers.

3.4.4.1 DEALING WITH PEOPLE

A large part of the project manager's role involves dealing with people. The project manager should study people's behaviors and motivations. The project manager should strive to be a good leader, because leadership is crucial to the success of projects in organizations. A project manager applies leadership skills and qualities when working with all project stakeholders, including the project team, the steering team, and project sponsors.

3.4.4.2 QUALITIES AND SKILLS OF A LEADER

Research shows that the qualities and skills of a leader include but are not limited to:

- ◆ Being a visionary (e.g., help to describe the products, goals, and objectives of the project; able to dream and translate those dreams for others);
- ◆ Being optimistic and positive;
- ◆ Being collaborative;
- ◆ Managing relationships and conflict by:
 - Building trust;
 - Satisfying concerns;
 - Seeking consensus;
 - Balancing competing and opposing goals;
 - Applying persuasion, negotiation, compromise, and conflict resolution skills;
 - Developing and nurturing personal and professional networks;
 - Taking a long-term view that relationships are just as important as the project; and
 - Continuously developing and applying political acumen.
- ◆ Communicating by:
 - Spending sufficient time communicating (research shows that top project managers spend about 90% of their time on a project in communicating);
 - Managing expectations;
 - Accepting feedback graciously;
 - Giving feedback constructively; and
 - Asking and listening.
- ◆ Being respectful (helping others retain their autonomy), courteous, friendly, kind, honest, trustworthy, loyal, and ethical;
- ◆ Exhibiting integrity and being culturally sensitive, courageous, a problem solver, and decisive;
- ◆ Giving credit to others where due;
- ◆ Being a life-long learner who is results- and action-oriented;

- ◆ Focusing on the important things, including:
 - Continuously prioritizing work by reviewing and adjusting as necessary;
 - Finding and using a prioritization method that works for them and the project;
 - Differentiating high-level strategic priorities, especially those related to critical success factors for the project;
 - Maintaining vigilance on primary project constraints;
 - Remaining flexible on tactical priorities; and
 - Being able to sift through massive amounts of information to obtain the most important information.
- ◆ Having a holistic and systemic view of the project, taking into account internal and external factors equally;
- ◆ Being able to apply critical thinking (e.g., application of analytical methods to reach decisions) and identify him or herself as a change agent.
- ◆ Being able to build effective teams, be service-oriented, and have fun and share humor effectively with team members.

3.4.4.3 POLITICS, POWER, AND GETTING THINGS DONE

Leadership and management are ultimately about being able to get things done. The skills and qualities noted help the project manager to achieve the project goals and objectives. At the root of many of these skills and qualities is the ability to deal with politics. Politics involves influence, negotiation, autonomy, and power.

Politics and its associated elements are not “good” or “bad,” “positive” or “negative” alone. The better the project manager understands how the organization works, the more likely he or she will be successful. The project manager observes and collects data about the project and organizational landscapes. The data then needs to be reviewed in the context of the project, the people involved, the organization, and the environment as a whole. This review yields the information and knowledge necessary for the project manager to plan and implement the most appropriate action. The project manager’s action is a result of selecting the right kind of power to influence and negotiate with others. Exercise of power also carries with it the responsibility of being sensitive to and respectful of other people. The effective action of the project manager maintains the autonomy of those involved. The project manager’s action results in the right people performing the activities necessary to fulfill the project’s objectives.

Power can originate with traits exhibited by the individual or the organization. Power is often supported by other people's perception of the leader. It is essential for project managers to be aware of their relationships with other people. Relationships enable project managers to get things done on the project. There are numerous forms of power at the disposal of project managers. Power and its use can be complex given its nature and the various factors at play in a project. Various forms of power include but are not limited to:

- ◆ Positional (sometimes called formal, authoritative, legitimate) (e.g., formal position granted in the organization or team);
- ◆ Informational (e.g., control of gathering or distribution);
- ◆ Referent (e.g., respect or admiration others hold for the individual, credibility gained);
- ◆ Situational (e.g., gained due to unique situation such as a specific crisis);
- ◆ Personal or charismatic (e.g., charm, attraction);
- ◆ Relational (e.g., participates in networking, connections, and alliances);
- ◆ Expert (e.g., skill, information possessed; experience, training, education, certification);
- ◆ Reward-oriented (e.g., ability to give praise, monetary or other desired items);
- ◆ Punitive or coercive (e.g., ability to invoke discipline or negative consequences);
- ◆ Ingratiating (e.g., application of flattery or other common ground to win favor or cooperation);
- ◆ Pressure-based (e.g., limit freedom of choice or movement for the purpose of gaining compliance to desired action);
- ◆ Guilt-based (e.g., imposition of obligation or sense of duty);
- ◆ Persuasive (e.g., ability to provide arguments that move people to a desired course of action); and
- ◆ Avoiding (e.g., refusing to participate).

Top project managers are proactive and intentional when it comes to power. These project managers will work to acquire the power and authority they need within the boundaries of organizational policies, protocols, and procedures rather than wait for it to be granted.



3.4.5 COMPARISON OF LEADERSHIP AND MANAGEMENT

The words *leadership* and *management* are often used interchangeably. However, they are not synonymous. The word *management* is more closely associated with directing another person to get from one point to another using a known set of expected behaviors. In contrast, leadership involves working with others through discussion or debate in order to guide them from one point to another.

The method that a project manager chooses to employ reveals a distinct difference in behavior, self-perception, and project role. Table 3-1 compares management and leadership on several important levels.

Project managers need to employ both leadership and management in order to be successful. The skill is in finding the right balance for each situation. The way in which management and leadership are employed often shows up in the project manager's leadership style.

Table 3-1. Team Management and Team Leadership Compared

Management	Leadership
Direct using positional power	Guide, influence, and collaborate using relational power
Maintain	Develop
Administrate	Innovate
Focus on systems and structure	Focus on relationships with people
Rely on control	Inspire trust
Focus on near-term goals	Focus on long-range vision
Ask how and when	Ask what and why
Focus on bottom line	Focus on the horizon
Accept status quo	Challenge status quo
Do things right	Do the right things
Focus on operational issues and problem solving	Focus on vision, alignment, motivation, and inspiration

3.4.5.1 LEADERSHIP STYLES

Project managers may lead their teams in many ways. The style a project manager selects may be a personal preference, or the result of the combination of multiple factors associated with the project. The style a project manager uses may change over time based on the factors in play. Major factors to consider include but are not limited to:

- ◆ Leader characteristics (e.g., attitudes, moods, needs, values, ethics);
- ◆ Team member characteristics (e.g., attitudes, moods, needs, values, ethics);
- ◆ Organizational characteristics (e.g., its purpose, structure, and type of work performed); and
- ◆ Environmental characteristics (e.g., social situation, economic state, and political elements).

Research describes numerous leadership styles that a project manager can adopt. Some of the most common examples of these styles include but are not limited to:

- ◆ Laissez-faire (e.g., allowing the team to make their own decisions and establish their own goals, also referred to as taking a hands-off style);
- ◆ Transactional (e.g., focus on goals, feedback, and accomplishment to determine rewards; management by exception);
- ◆ Servant leader (e.g., demonstrates commitment to serve and put other people first; focuses on other people's growth, learning, development, autonomy, and well-being; concentrates on relationships, community and collaboration; leadership is secondary and emerges after service);
- ◆ Transformational (e.g., empowering followers through idealized attributes and behaviors, inspirational motivation, encouragement for innovation and creativity, and individual consideration);
- ◆ Charismatic (e.g., able to inspire; is high-energy, enthusiastic, self-confident; holds strong convictions); and
- ◆ Interactional (e.g., a combination of transactional, transformational, and charismatic).



3.4.5.2 PERSONALITY

Personality refers to the individual differences in characteristic patterns of thinking, feeling, and behaving. Personality characteristics or traits include but are not limited to:

- ◆ Authentic (e.g., accepts others for what and who they are, show open concern);
- ◆ Courteous (e.g., ability to apply appropriate behavior and etiquette);
- ◆ Creative (e.g., ability to think abstractly, to see things differently, to innovate);
- ◆ Cultural (e.g., measure of sensitivity to other cultures including values, norms, and beliefs);
- ◆ Emotional (e.g., ability to perceive emotions and the information they present and to manage them; measure of interpersonal skills);
- ◆ Intellectual (e.g., measure of human intelligence over multiple aptitudes);
- ◆ Managerial (e.g., measure of management practice and potential);
- ◆ Political (e.g., measure of political intelligence and making things happen);
- ◆ Service-oriented (e.g., evidence of willingness to serve other people);
- ◆ Social (e.g., ability to understand and manage people); and
- ◆ Systemic (e.g., drive to understand and build systems).

An effective project manager will have some level of ability with each of these characteristics in order to be successful. Each project, organization, and situation requires that the project manager emphasize different aspects of personality.

3.5 PERFORMING INTEGRATION

The role of the project manager is twofold when performing integration on the project:

- ◆ Project managers play a key role in working with the project sponsor to understand the strategic objectives and ensure the alignment of the project objectives and results with those of the portfolio, program, and business areas. In this way, project managers contribute to the integration and execution of the strategy.
- ◆ Project managers are responsible for guiding the team to work together to focus on what is really essential at the project level. This is achieved through the integration of processes, knowledge, and people.

Integration is a critical skill for project managers. Integration is covered more in depth in the Project Integration Management Knowledge Area of this guide. Sections 3.5.1 through 3.5.4 focus on integration that takes place at three different levels: the process, cognitive, and context levels. Section 3.5.4 concludes by addressing complexity and integration.

3.5.1 PERFORMING INTEGRATION AT THE PROCESS LEVEL

Project management may be seen as a set of processes and activities that are undertaken to achieve the project objectives. Some of these processes may take place once (e.g., the initial creation of the project charter), but many others overlap and occur several times throughout the project. One example of this process overlap and multiple occurrences is a change in a requirement that impacts scope, schedule, or budget and requires a change request. Several project management processes such as the Control Scope process and the Perform Integrated Change Control process may involve a change request. The Perform Integrated Change Control process occurs throughout the project for integrating change requests.

Although there is no stated definition on how to integrate the project processes, it is clear that a project has a small chance of meeting its objective when the project manager fails to integrate the project processes where they interact.

3.5.2 INTEGRATION AT THE COGNITIVE LEVEL

There are many different ways to manage a project, and the method selected typically depends on the specific characteristics of the project including its size, how complicated the project or organization may be, and the culture of the performing organization. It is clear that the personal skills and abilities of the project manager are closely related to the way in which the project is managed.

The project manager should strive to become proficient in all of the Project Management Knowledge Areas. In concert with proficiency in these Knowledge Areas, the project manager applies experience, insight, leadership, and technical and business management skills to the project. Finally, it is through the project manager's ability to integrate the processes in these Knowledge Areas that makes it possible to achieve the desired project results.

3.5.3 INTEGRATION AT THE CONTEXT LEVEL

There have been many changes in the context in which business and projects take place today compared to a few decades ago. New technologies have been introduced. Social networks, multicultural aspects, virtual teams, and new values are part of the new reality of projects. An example is knowledge and people integration in the context of a large cross-functional project implementation involving multiple organizations. The project manager considers the implications of this context in communications planning and knowledge management for guiding the project team.

Project managers need to be cognizant of the project context and these new aspects when managing the integration. Then project managers can decide how to best use these new elements of the environment in their projects to achieve success.

3.5.4 INTEGRATION AND COMPLEXITY

Some projects may be referred to as complex and considered difficult to manage. In simple terms, complex and complicated are concepts often used to describe what is considered to be intricate or complicated.

Complexity within projects is a result of the organization's system behavior, human behavior, and the uncertainty at work in the organization or its environment. In *Navigating Complexity: A Practice Guide* [13], these three dimensions of complexity are defined as:

- ◆ **System behavior.** The interdependencies of components and systems.
- ◆ **Human behavior.** The interplay between diverse individuals and groups.
- ◆ **Ambiguity.** Uncertainty of emerging issues and lack of understanding or confusion.

Complexity itself is a perception of an individual based on personal experience, observation, and skill. Rather than being complex, a project is more accurately described as containing complexity. Portfolios, programs, and projects may contain elements of complexity.

When approaching the integration of a project, the project manager should consider elements that are both inside and outside of the project. The project manager should examine the characteristics or properties of the project. Complexity as a characteristic or property of a project is typically defined as:

- ◆ Containing multiple parts,
- ◆ Possessing a number of connections between the parts,
- ◆ Exhibiting dynamic interactions between the parts, and
- ◆ Exhibiting behavior produced as a result of those interactions that cannot be explained as the simple sum of the parts (e.g., emergent behavior).

Examining these various items that appear to make the project complex should help the project manager identify key areas when planning, managing, and controlling the project to ensure integration.

4

PROJECT INTEGRATION MANAGEMENT

Project Integration Management includes the processes and activities to identify, define, combine, unify, and coordinate the various processes and project management activities within the Project Management Process Groups. In the project management context, integration includes characteristics of unification, consolidation, communication, and interrelationship. These actions should be applied from the start of the project through completion. Project Integration Management includes making choices about:

- ◆ Resource allocation,
- ◆ Balancing competing demands,
- ◆ Examining any alternative approaches,
- ◆ Tailoring the processes to meet the project objectives, and
- ◆ Managing the interdependencies among the Project Management Knowledge Areas.



The Project Integration Management processes are:

4.1 Develop Project Charter—The process of developing a document that formally authorizes the existence of a project and provides the project manager with the authority to apply organizational resources to project activities.

4.2 Develop Project Management Plan—The process of defining, preparing, and coordinating all plan components and consolidating them into an integrated project management plan.

4.3 Direct and Manage Project Work—The process of leading and performing the work defined in the project management plan and implementing approved changes to achieve the project's objectives.

4.4 Manage Project Knowledge—The process of using existing knowledge and creating new knowledge to achieve the project's objectives and contribute to organizational learning.

4.5 Monitor and Control Project Work—The process of tracking, reviewing, and reporting overall progress to meet the performance objectives defined in the project management plan.

4.6 Perform Integrated Change Control—The process of reviewing all change requests; approving changes and managing changes to deliverables, organizational process assets, project documents, and the project management plan; and communicating the decisions.

4.7 Close Project or Phase—The process of finalizing all activities for the project, phase, or contract.

Figure 4-1 provides an overview of the Project Integration Management processes. The Project Integration Management processes are presented as discrete processes with defined interfaces while, in practice, they overlap and interact in ways that cannot be completely detailed in the *PMBOK® Guide*.



**Project Integration
Management Overview**

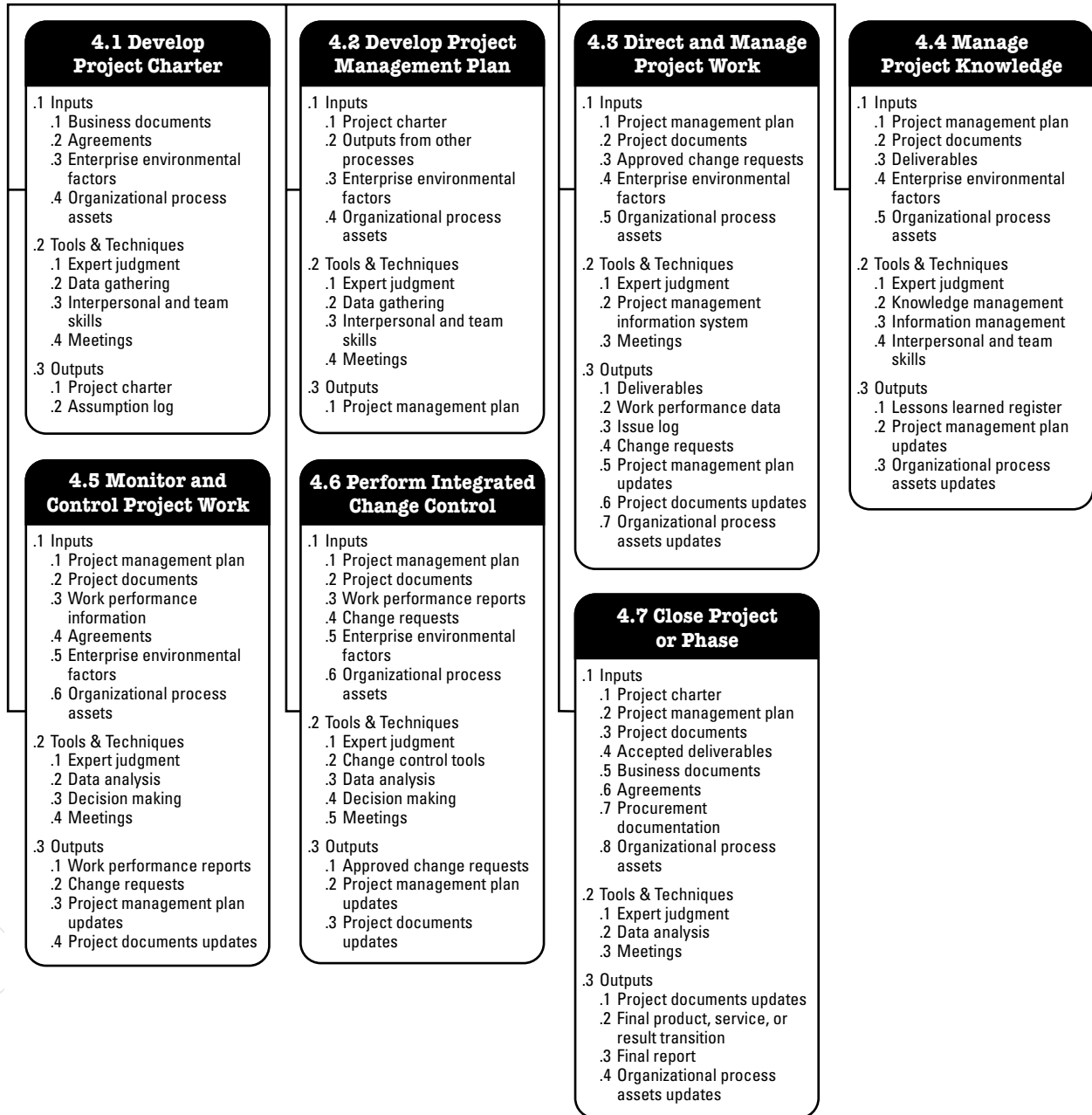

Figure 4-1. Project Integration Management Overview

KEY CONCEPTS FOR PROJECT INTEGRATION MANAGEMENT

Project Integration Management is specific to project managers. Whereas other Knowledge Areas may be managed by specialists (e.g., cost analysis, scheduling specialists, risk management experts), the accountability of Project Integration Management cannot be delegated or transferred. The project manager is the one who combines the results in all the other Knowledge Areas and has the overall view of the project. The project manager is ultimately responsible for the project as a whole.

Projects and project management are integrative by nature. For example, a cost estimate needed for a contingency plan involves integrating the processes in the Project Cost Management, Project Schedule Management, and Project Risk Management Knowledge Areas. When additional risks associated with various staffing alternatives are identified, then one or more of those processes may be revisited.

The links among the processes in the Project Management Process Groups are often iterative. For example, the Planning Process Group provides the Executing Process Group with a documented project management plan early in the project and then updates the project management plan if changes occur as the project progresses.

Project Integration Management is about:

- ◆ Ensuring that the deliverable due dates of the product, service, or result; project life cycle; and the benefits management plan are aligned;
- ◆ Providing a project management plan to achieve the project objectives;
- ◆ Ensuring the creation and the use of the appropriate knowledge to and from the project as necessary;
- ◆ Managing the performance and changes of the activities in the project management plan;
- ◆ Making integrated decisions regarding key changes impacting the project;
- ◆ Measuring and monitoring the project's progress and taking appropriate action to meet project objectives;
- ◆ Collecting data on the results achieved, analyzing the data to obtain information, and communicating this information to relevant stakeholders;
- ◆ Completing all the work of the project and formally closing each phase, contract, and the project as a whole; and
- ◆ Managing phase transitions when necessary.

The more complex the project and the more varied the expectations of the stakeholders, the more a sophisticated approach to integration is needed.

TRENDS AND EMERGING PRACTICES IN PROJECT INTEGRATION MANAGEMENT

The Project Integration Management Knowledge Area requires combining the results from all the other Knowledge Areas. Evolving trends in integration processes include but are not limited to:

- ◆ **Use of automated tools.** The volume of data and information that project managers need to integrate makes it necessary to use a project management information system (PMIS) and automated tools to collect, analyze, and use information to meet project objectives and realize project benefits.
- ◆ **Use of visual management tools.** Some project teams use visual management tools, rather than written plans and other documents, to capture and oversee critical project elements. Making key project elements visible to the entire team provides a real-time overview of the project status, facilitates knowledge transfer, and empowers team members and other stakeholders to help identify and solve issues.
- ◆ **Project knowledge management.** The increasingly mobile and transitory work force requires a more rigorous process of identifying knowledge throughout the project life cycle and transferring it to the target audience so that the knowledge is not lost.
- ◆ **Expanding the project manager's responsibilities.** Project managers are being called on to initiate and finalize the project, such as project business case development and benefits management. Historically, these activities have been the responsibility of management and the project management office, but project managers are more frequently collaborating with them to better meet project objectives and deliver benefits. Project managers are also engaging in more comprehensive identification and engagement of stakeholders. This includes managing the interfaces with various functional and operational departments and senior management personnel.
- ◆ **Hybrid methodologies.** Some project management methodologies are evolving to incorporate successfully applied new practices. Examples include the use of agile and other iterative practices; business analysis techniques for requirements management; tools for identifying complex elements in projects; and organizational change management methods to prepare for transitioning the project outputs into the organization.

TAILORING CONSIDERATIONS

Because each project is unique, the project manager may need to tailor the way that Project Integration Management processes are applied. Considerations for tailoring include but are not limited to:

- ◆ **Project life cycle.** What is an appropriate project life cycle? What phases should comprise the project life cycle?
- ◆ **Development life cycle.** What development life cycle and approach are appropriate for the product, service, or result? Is a predictive or adaptive approach appropriate? If adaptive, should the product be developed incrementally or iteratively? Is a hybrid approach best?
- ◆ **Management approaches.** What management processes are most effective based on the organizational culture and the complexity of the project?
- ◆ **Knowledge management.** How will knowledge be managed in the project to foster a collaborative working environment?
- ◆ **Change.** How will change be managed in the project?
- ◆ **Governance.** What control boards, committees, and other stakeholders are part of the project? What are the project status reporting requirements?
- ◆ **Lessons learned.** What information should be collected throughout and at the end of the project? How will historical information and lessons learned be made available to future projects?
- ◆ **Benefits.** When and how should benefits be reported: at the end of the project or at the end of each iteration or phase?

CONSIDERATIONS FOR AGILE/ADAPTIVE ENVIRONMENTS

Iterative and agile approaches promote the engagement of team members as local domain experts in integration management. The team members determine how plans and components should integrate.

The expectations of the project manager as noted in the *Key Concepts for Integration Management* do not change in an adaptive environment, but control of the detailed product planning and delivery is delegated to the team. The project manager's focus is on building a collaborative decision-making environment and ensuring the team has the ability to respond to changes. This collaborative approach can be further enhanced when team members possess a broad skill base rather than a narrow specialization.

4.1 DEVELOP PROJECT CHARTER

Develop Project Charter is the process of developing a document that formally authorizes the existence of a project and provides the project manager with the authority to apply organizational resources to project activities. The key benefits of this process are that it provides a direct link between the project and the strategic objectives of the organization, creates a formal record of the project, and shows the organizational commitment to the project. This process is performed once or at predefined points in the project. The inputs, tools and techniques, and outputs of the process are depicted in Figure 4-2. Figure 4-3 depicts the data flow diagram for the process.

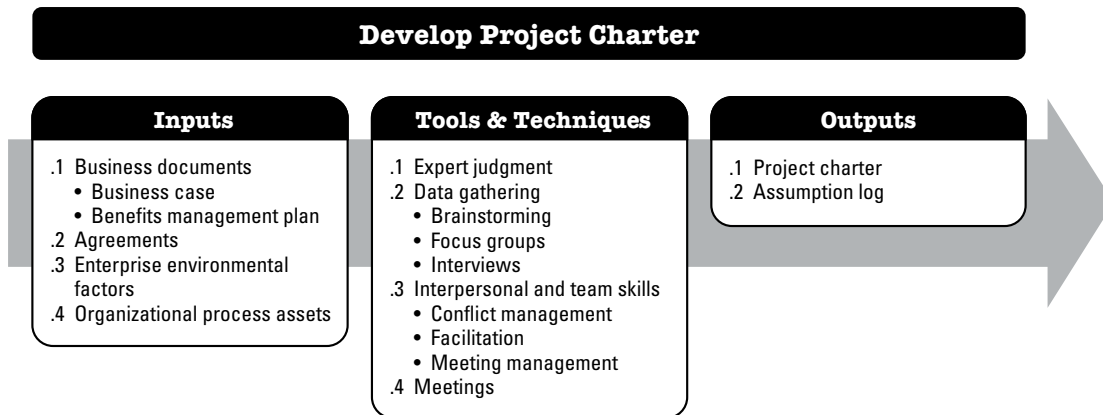

Figure 4-2. Develop Project Charter: Inputs, Tools & Techniques, and Outputs

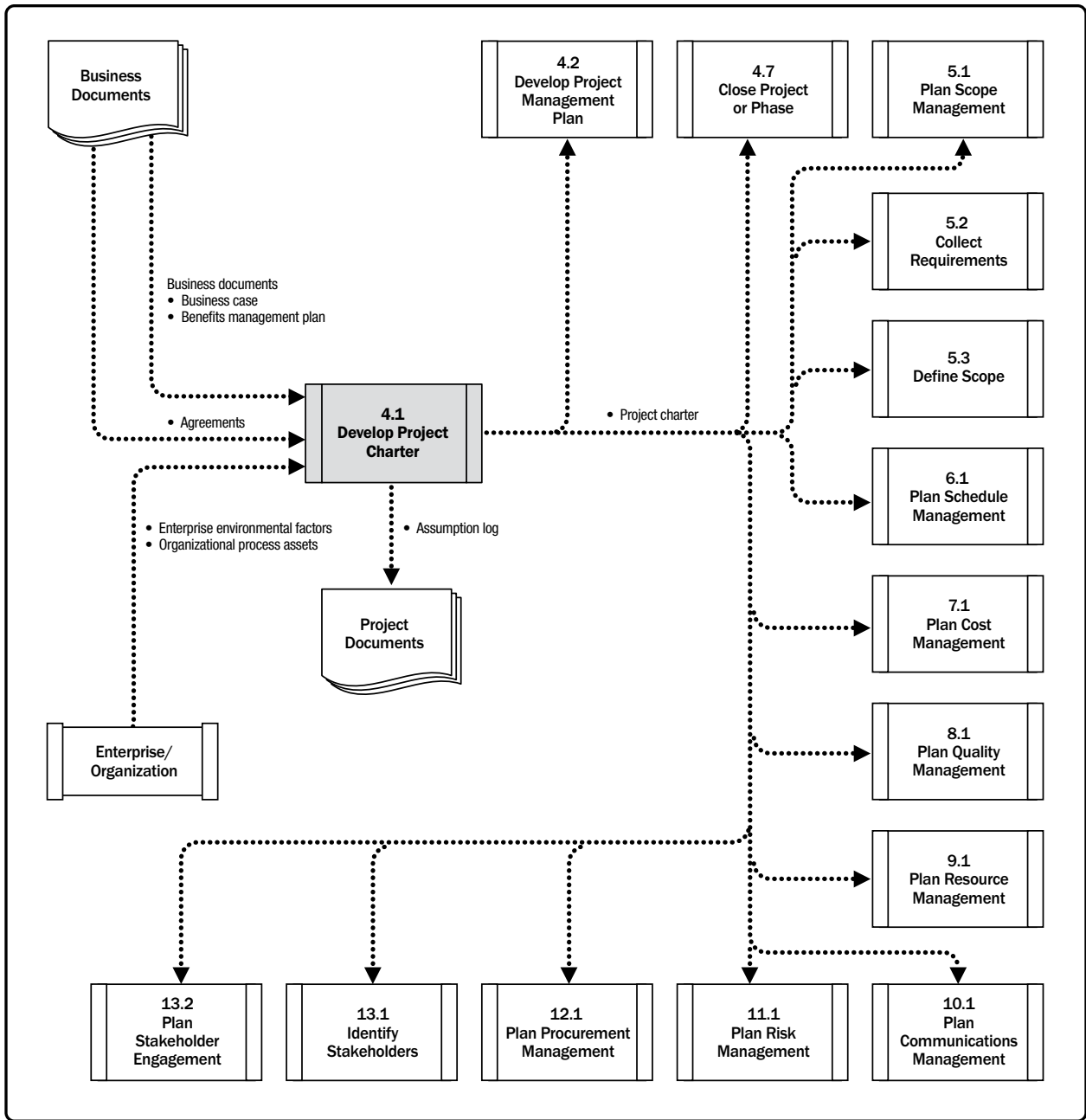

Figure 4-3. Develop Project Charter: Data Flow Diagram

The project charter establishes a partnership between the performing and requesting organizations. In the case of external projects, a formal contract is typically the preferred way to establish an agreement. A project charter may still be used to establish internal agreements within an organization to ensure proper delivery under the contract. The approved project charter formally initiates the project. A project manager is identified and assigned as early in the project as is feasible, preferably while the project charter is being developed and always prior to the start of planning. The project charter can be developed by the sponsor or the project manager in collaboration with the initiating entity. This collaboration allows the project manager to have a better understanding of the project purpose, objectives, and expected benefits. This understanding will better allow for efficient resource allocation to project activities. The project charter provides the project manager with the authority to plan, execute, and control the project.

Projects are initiated by an entity external to the project such as a sponsor, program, or project management office (PMO), or a portfolio governing body chairperson or authorized representative. The project initiator or sponsor should be at a level that is appropriate to procure funding and commit resources to the project. Projects are initiated due to internal business needs or external influences. These needs or influences often trigger the creation of a needs analysis, feasibility study, business case, or description of the situation that the project will address. Chartering a project validates alignment of the project to the strategy and ongoing work of the organization. A project charter is not considered to be a contract because there is no consideration or money promised or exchanged in its creation.

4.1.1 DEVELOP PROJECT CHARTER: INPUTS

4.1.1.1 BUSINESS DOCUMENTS

The business case (described in Section 1.2.6.1) and the benefits management plan (described in Section 1.2.6.2) are sources of information about the project's objectives and how the project will contribute to the business goals. Although the business documents are developed prior to the project, they are reviewed periodically.

- ◆ **Business case.** The approved business case, or similar, is the business document most commonly used to create the project charter. The business case describes the necessary information from a business standpoint to determine whether the expected outcomes of the project justify the required investment. It is commonly used for decision making by managers or executives above the project level. Typically, the business need and the cost-benefit analysis are contained in the business case to justify and establish boundaries for the project. For more information on the business case, see Section 1.2.6.1. The business case is created as a result of one or more of the following:

- *Market demand* (e.g., an automobile manufacturer authorizing a project to build more fuel-efficient cars in response to gasoline shortages),
- *Organizational need* (e.g., due to high overhead costs, a company may combine staff functions and streamline processes to reduce costs),
- *Customer request* (e.g., an electric utility authorizing a project to build a new substation to serve a new industrial park),
- *Technological advance* (e.g., an airline authorizing a new project to develop electronic tickets instead of paper tickets based on technological advances),
- *Legal requirement* (e.g., a paint manufacturer authorizing a project to establish guidelines for handling toxic materials),
- *Ecological impacts* (e.g., a company authorizing a project to lessen its environmental impact), or
- *Social need* (e.g., a nongovernmental organization in a developing country authorizing a project to provide potable water systems, latrines, and sanitation education to communities suffering from high rates of cholera).

The project charter incorporates the appropriate information for the project from the business documents. The project manager does not update or modify the business documents since they are not project documents; however, the project manager may make recommendations.

4.1.1.2 AGREEMENTS

Described in Section 12.2.3.2. Agreements are used to define initial intentions for a project. Agreements may take the form of contracts, memorandums of understanding (MOUs), service level agreements (SLA), letters of agreement, letters of intent, verbal agreements, email, or other written agreements. Typically, a contract is used when a project is being performed for an external customer.

4.1.1.3 ENTERPRISE ENVIRONMENTAL FACTORS

The enterprise environmental factors that can influence the Develop Project Charter process include but are not limited to:

- ◆ Government or industry standards (e.g., product standards, quality standards, safety standards, and workmanship standards),
- ◆ Legal and regulatory requirements and/or constraints,
- ◆ Marketplace conditions,
- ◆ Organizational culture and political climate,
- ◆ Organizational governance framework (a structured way to provide control, direction, and coordination through people, policies, and processes to meet organizational strategic and operational goals), and
- ◆ Stakeholders' expectations and risk thresholds.

4.1.1.4 ORGANIZATIONAL PROCESS ASSETS

The organizational process assets that can influence the Develop Project Charter process include but are not limited to:

- ◆ Organizational standard policies, processes, and procedures;
- ◆ Portfolio, program, and project governance framework (governance functions and processes to provide guidance and decision making);
- ◆ Monitoring and reporting methods;
- ◆ Templates (e.g., project charter template); and
- ◆ Historical information and lessons learned repository (e.g., project records and documents, information about the results of previous project selection decisions, and information about previous project performance).

4.1.2 DEVELOP PROJECT CHARTER: TOOLS AND TECHNIQUES

4.1.2.1 EXPERT JUDGMENT

Expert judgment is defined as judgment provided based upon expertise in an application area, Knowledge Area, discipline, industry, etc., as appropriate for the activity being performed. Such expertise may be provided by any group or person with specialized education, knowledge, skill, experience, or training.

For this process, expertise should be considered from individuals or groups with specialized knowledge of or training in the following topics:

- ◆ Organizational strategy,
- ◆ Benefits management,
- ◆ Technical knowledge of the industry and focus area of the project,
- ◆ Duration and budget estimation, and
- ◆ Risk identification.

4.1.2.2 DATA GATHERING

Data-gathering techniques that can be used for this process include but are not limited to:

- ◆ **Brainstorming.** This technique is used to identify a list of ideas in a short period of time. It is conducted in a group environment and is led by a facilitator. Brainstorming comprises two parts: idea generation and analysis. Brainstorming can be used to gather data and solutions or ideas from stakeholders, subject matter experts, and team members when developing the project charter.
- ◆ **Focus groups.** Described in Section 5.2.2.2. Focus groups bring together stakeholders and subject matter experts to learn about the perceived project risk, success criteria, and other topics in a more conversational way than a one-on-one interview.
- ◆ **Interviews.** Described in Section 5.2.2.2. Interviews are used to obtain information on high-level requirements, assumptions or constraints, approval criteria, and other information from stakeholders by talking directly to them.

4.1.2.3 INTERPERSONAL AND TEAM SKILLS

Interpersonal and team skills that can be used for this process include but are not limited to:

- ◆ **Conflict management.** Described in Section 9.5.2.1. Conflict management can be used to help bring stakeholders into alignment on the objectives, success criteria, high-level requirements, project description, summary milestones, and other elements of the charter.
- ◆ **Facilitation.** Facilitation is the ability to effectively guide a group event to a successful decision, solution, or conclusion. A facilitator ensures that there is effective participation, that participants achieve a mutual understanding, that all contributions are considered, that conclusions or results have full buy-in according to the decision process established for the project, and that the actions and agreements achieved are appropriately dealt with afterward.
- ◆ **Meeting management.** Described in Section 10.2.2.6. Meeting management includes preparing the agenda, ensuring that a representative for each key stakeholder group is invited, and preparing and sending the follow-up minutes and actions.

4.1.2.4 MEETINGS

For this process, meetings are held with key stakeholders to identify the project objectives, success criteria, key deliverables, high-level requirements, summary milestones, and other summary information.

4.1.3 DEVELOP PROJECT CHARTER: OUTPUTS

4.1.3.1 PROJECT CHARTER

The project charter is the document issued by the project initiator or sponsor that formally authorizes the existence of a project and provides the project manager with the authority to apply organizational resources to project activities. It documents the high-level information on the project and on the product, service, or result the project is intended to satisfy, such as:

- ◆ Project purpose;
- ◆ Measurable project objectives and related success criteria;
- ◆ High-level requirements;
- ◆ High-level project description, boundaries, and key deliverables;
- ◆ Overall project risk;
- ◆ Summary milestone schedule;
- ◆ Preapproved financial resources;
- ◆ Key stakeholder list;
- ◆ Project approval requirements (i.e., what constitutes project success, who decides the project is successful, and who signs off on the project);
- ◆ Project exit criteria (i.e., what are the conditions to be met in order to close or to cancel the project or phase);
- ◆ Assigned project manager, responsibility, and authority level; and
- ◆ Name and authority of the sponsor or other person(s) authorizing the project charter.

At a high level, the project charter ensures a common understanding by the stakeholders of the key deliverables, milestones, and the roles and responsibilities of everyone involved in the project.

4.1.3.2 ASSUMPTION LOG

High-level strategic and operational assumptions and constraints are normally identified in the business case before the project is initiated and will flow into the project charter. Lower-level activity and task assumptions are generated throughout the project such as defining technical specifications, estimates, the schedule, risks, etc. The assumption log is used to record all assumptions and constraints throughout the project life cycle.

4.2 DEVELOP PROJECT MANAGEMENT PLAN

Develop Project Management Plan is the process of defining, preparing, and coordinating all plan components and consolidating them into an integrated project management plan. The key benefit of this process is the production of a comprehensive document that defines the basis of all project work and how the work will be performed. This process is performed once or at predefined points in the project. The inputs, tools and techniques, and outputs of the process are depicted in Figure 4-4. Figure 4-5 depicts the data flow diagram for the process.

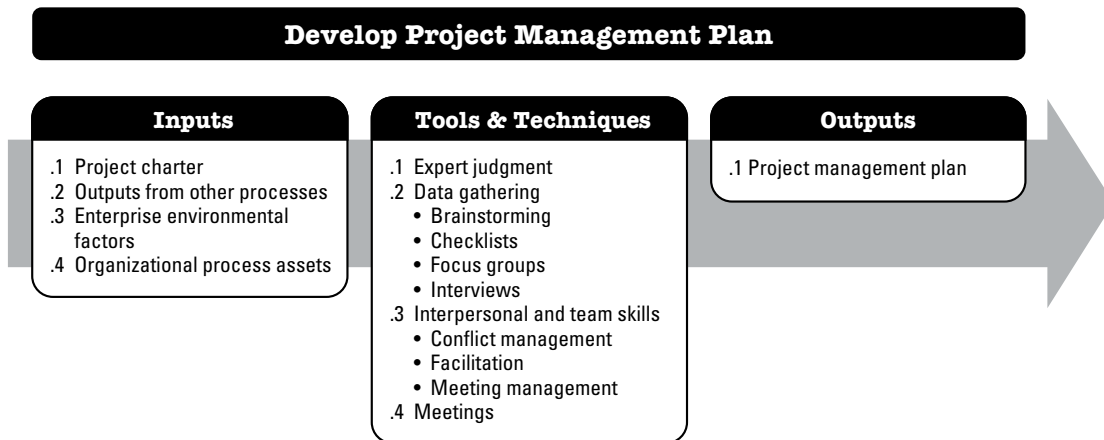

Figure 4-4. Develop Project Management Plan: Inputs, Tools & Techniques, and Outputs

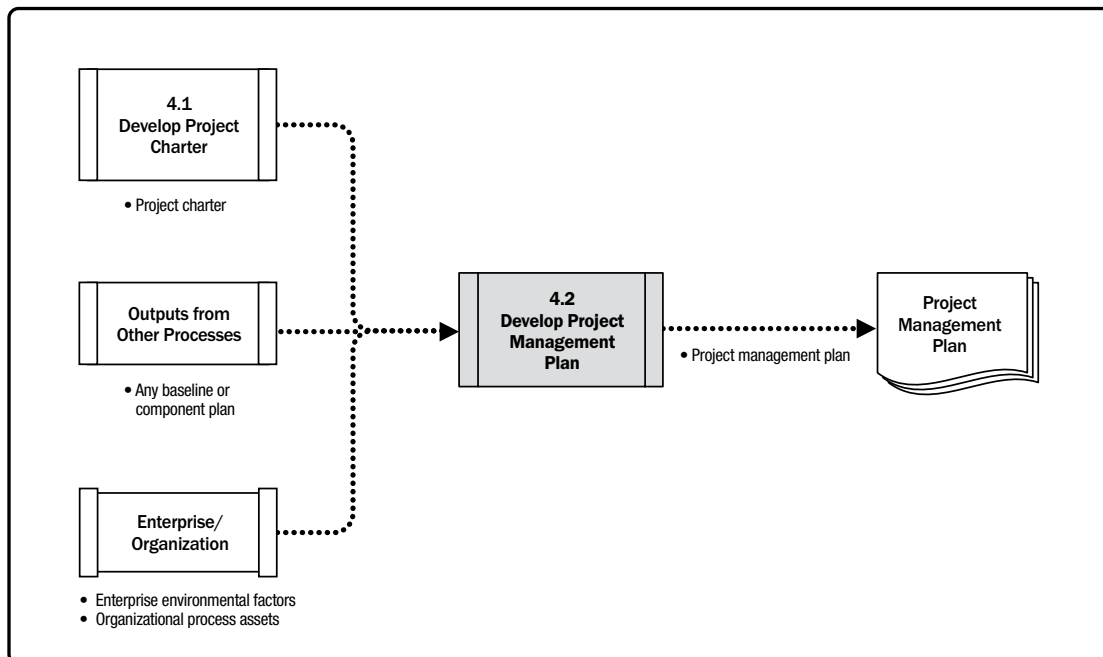

Figure 4-5. Develop Project Management Plan: Data Flow Diagram

The project management plan defines how the project is executed, monitored and controlled, and closed. The project management plan's content varies depending on the application area and complexity of the project.

The project management plan may be either summary level or detailed. Each component plan is described to the extent required by the specific project. The project management plan should be robust enough to respond to an ever-changing project environment. This agility may result in more accurate information as the project progresses.

The project management plan should be baselined; that is, it is necessary to define at least the project references for scope, time, and cost, so that the project execution can be measured and compared to those references and performance can be managed. Before the baselines are defined, the project management plan may be updated as many times as necessary. No formal process is required at that time. But, once it is baselined, it may only be changed through the Perform Integrated Change Control process. Consequently, change requests will be generated and decided upon whenever a change is requested. This results in a project management plan that is progressively elaborated by controlled and approved updates extending through project closure.

Projects that exist in the context of a program or portfolio should develop a project management plan that is consistent with the program or portfolio management plan. For example, if the program management plan indicates all changes exceeding a specified cost need to be reviewed by the change control board (CCB), then this process and cost threshold need to be defined in the project management plan.

4.2.1 DEVELOP PROJECT MANAGEMENT PLAN: INPUTS

4.2.1.1 PROJECT CHARTER

Described in Section 4.1.3.1. The project team uses the project charter as a starting point for initial project planning. The type and amount of information in the project charter varies depending on the complexity of the project and the information known at the time of its creation. At a minimum, the project charter should define the high-level information about the project that will be elaborated in the various components of the project management plan.

4.2.1.2 OUTPUTS FROM OTHER PROCESSES

Outputs from many of the other processes described in Sections 5 through 13 are integrated to create the project management plan. Subsidiary plans and baselines that are an output from other planning processes are inputs to this process. In addition, changes to these documents may necessitate updates to the project management plan.

4.2.1.3 ENTERPRISE ENVIRONMENTAL FACTORS

The enterprise environmental factors that can influence the Develop Project Management Plan process include but are not limited to:

- ◆ Government or industry standards (e.g., product standards, quality standards, safety standards, and workmanship standards);
- ◆ Legal and regulatory requirements and/or constraints;
- ◆ Project management body of knowledge for vertical market (e.g., construction) and/or focus area (e.g., environmental, safety, risk, or agile software development);
- ◆ Organizational structure, culture, management practices, and sustainability;
- ◆ Organizational governance framework (a structured way to provide control, direction, and coordination through people, policies, and processes to meet organizational strategic and operational goals); and
- ◆ Infrastructure (e.g., existing facilities and capital equipment).

4.2.1.4 ORGANIZATIONAL PROCESS ASSETS

The organizational process assets that can influence the Develop Project Management Plan process include but are not limited to:

- ◆ Organizational standard policies, processes, and procedures;
- ◆ Project management plan template, including:
 - Guidelines and criteria for tailoring the organization's set of standard processes to satisfy the specific needs of the project, and
 - Project closure guidelines or requirements such as the product validation and acceptance criteria.
- ◆ Change control procedures, including the steps by which official organizational standards, policies, plans, procedures, or any project documents will be modified and how any changes will be approved and validated;
- ◆ Monitoring and reporting methods, risk control procedures, and communication requirements;
- ◆ Project information from previous similar projects (e.g., scope, cost, schedule and performance measurement baselines, project calendars, project schedule network diagrams, and risk registers); and
- ◆ Historical information and lessons learned repository.

4.2.2 DEVELOP PROJECT MANAGEMENT PLAN: TOOLS AND TECHNIQUES

4.2.2.1 EXPERT JUDGMENT

Described in Section 4.1.2.1. Expertise should be considered from individuals or groups with specialized knowledge of or training in the following topics:

- ◆ Tailoring the project management process to meet the project needs, including the dependencies and interactions among those processes and the essential inputs and outputs;
- ◆ Developing additional components of the project management plan if needed;
- ◆ Determining the tools and techniques to be used for accomplishing those processes;
- ◆ Developing technical and management details to be included in the project management plan;
- ◆ Determining resources and skill levels needed to perform project work;
- ◆ Defining the level of configuration management to apply on the project;
- ◆ Determining which project documents will be subject to the formal change control process; and
- ◆ Prioritizing the work on the project to ensure the project resources are allocated to the appropriate work at the appropriate time.

4.2.2.2 DATA GATHERING

Data-gathering techniques that can be used for this process include but are not limited to:

- ◆ **Brainstorming.** Described in Section 4.1.2.2. Brainstorming is frequently used when developing the project management plan to gather ideas and solutions about the project approach. Attendees include the project team members although other subject matter experts (SMEs) or stakeholders may also participate.
- ◆ **Checklists.** Described in Section 11.2.2.2. Many organizations have standardized checklists available based in their own experience or use checklists from the industry. A checklist may guide the project manager to develop the plan or may help to verify that all the required information is included in the project management plan.
- ◆ **Focus groups.** Described in Section 5.2.2.2. Focus groups bring together stakeholders to discuss the project management approach and the integration of the different components of the project management plan.
- ◆ **Interviews.** Described in Section 5.2.2.2. Interviews are used to obtain specific information from stakeholders to develop the project management plan or any component plan or project document.

4.2.2.3 INTERPERSONAL AND TEAM SKILLS

The interpersonal and team skills used when developing the project management plan include:

- ◆ **Conflict management.** Described in Section 9.5.2.1. Conflict management may be necessary to bring diverse stakeholders into alignment on all aspects of the project management plan.
- ◆ **Facilitation.** Described in Section 4.1.2.3. Facilitation ensures that there is effective participation, that participants achieve a mutual understanding, that all contributions are considered, and that conclusions or results have full buy-in according to the decision process established for the project.
- ◆ **Meeting management.** Described in Section 10.2.2.6. Meeting management is necessary to ensure that the numerous meetings that are necessary to develop, unify, and agree on the project management plan are well run.

4.2.2.4 MEETINGS

For this process, meetings are used to discuss the project approach, determine how work will be executed to accomplish the project objectives, and establish the way the project will be monitored and controlled.

The project kick-off meeting is usually associated with the end of planning and the start of executing. Its purpose is to communicate the objectives of the project, gain the commitment of the team for the project, and explain the roles and responsibilities of each stakeholder. The kick-off may occur at different points in time depending on the characteristics of the project:

- ◆ For small projects, there is usually only one team that performs the planning and the execution. In this case, the kick-off occurs shortly after initiation, in the Planning Process Group, because the team is involved in planning.
- ◆ In large projects, a project management team normally does the majority of the planning, and the remainder of the project team is brought on when the initial planning is complete, at the start of the development/implementation. In this instance, the kick-off meeting takes place with processes in the Executing Process Group.

Multiphase projects will typically include a kick-off meeting at the beginning of each phase.

4.2.3 DEVELOP PROJECT MANAGEMENT PLAN: OUTPUTS

4.2.3.1 PROJECT MANAGEMENT PLAN

The project management plan is the document that describes how the project will be executed, monitored and controlled, and closed. It integrates and consolidates all of the subsidiary management plans and baselines, and other information necessary to manage the project. The needs of the project determine which components of the project management plan are needed.

Project management plan components include but are not limited to:

◆ **Subsidiary management plans:**

- *Scope management plan.* Described in Section 5.1.3.1. Establishes how the scope will be defined, developed, monitored, controlled, and validated.
- *Requirements management plan.* Described in Section 5.1.3.2. Establishes how the requirements will be analyzed, documented, and managed.
- *Schedule management plan.* Described in Section 6.1.3.1. Establishes the criteria and the activities for developing, monitoring, and controlling the schedule.
- *Cost management plan.* Described in Section 7.1.3.1. Establishes how the costs will be planned, structured, and controlled.
- *Quality management plan.* Described in Section 8.1.3.1. Establishes how an organization's quality policies, methodologies, and standards will be implemented in the project.
- *Resource management plan.* Described in Section 9.1.3.1 Provides guidance on how project resources should be categorized, allocated, managed, and released.
- *Communications management plan.* Described in Section 10.1.3.1. Establishes how, when, and by whom information about the project will be administered and disseminated.
- *Risk management plan.* Described in Section 11.1.3.1. Establishes how the risk management activities will be structured and performed.
- *Procurement management plan.* Described in Section 12.1.3.1. Establishes how the project team will acquire goods and services from outside of the performing organization.
- *Stakeholder engagement plan.* Described in Section 13.2.3.1. Establishes how stakeholders will be engaged in project decisions and execution, according to their needs, interests, and impact.

◆ **Baselines:**

- *Scope baseline.* Described in Section 5.4.3.1. The approved version of a scope statement, work breakdown structure (WBS), and its associated WBS dictionary, which is used as a basis for comparison.
- *Schedule baseline.* Described in Section 6.5.3.1. The approved version of the schedule model that is used as a basis for comparison to the actual results.
- *Cost baseline.* Described in Section 7.3.3.1. The approved version of the time-phased project budget that is used as a basis for comparison to the actual results.

- ◆ **Additional components.** Most components of the project management plan are produced as outputs from other processes, though some are produced during this process. Those components developed as part of this process will be dependent on the project; however, they often include but are not limited to:
 - *Change management plan.* Describes how the change requests throughout the project will be formally authorized and incorporated.
 - *Configuration management plan.* Describes how the information about the items of the project (and which items) will be recorded and updated so that the product, service, or result of the project remains consistent and/or operative.
 - *Performance measurement baseline.* An integrated scope-schedule-cost plan for the project work against which project execution is compared to measure and manage performance.
 - *Project life cycle.* Describes the series of phases that a project passes through from its initiation to its closure.
 - *Development approach.* Describes the product, service, or result development approach, such as predictive, iterative, agile, or a hybrid model.
 - *Management reviews.* Identifies the points in the project when the project manager and relevant stakeholders will review the project progress to determine if performance is as expected, or if preventive or corrective actions are necessary.

While the project management plan is one of the primary documents used to manage the project, other project documents are also used. These other documents are not part of the project management plan; however, they are necessary to manage the project effectively. Table 4-1 is a representative list of the project management plan components and project documents.

Table 4-1. Project Management Plan and Project Documents

Project Management Plan	Project Documents	
1. Scope management plan	1. Activity attributes	19. Quality control measurements
2. Requirements management plan	2. Activity list	20. Quality metrics
3. Schedule management plan	3. Assumption log	21. Quality report
4. Cost management plan	4. Basis of estimates	22. Requirements documentation
5. Quality management plan	5. Change log	23. Requirements traceability matrix
6. Resource management plan	6. Cost estimates	24. Resource breakdown structure
7. Communications management plan	7. Cost forecasts	25. Resource calendars
8. Risk management plan	8. Duration estimates	26. Resource requirements
9. Procurement management plan	9. Issue log	27. Risk register
10. Stakeholder engagement plan	10. Lessons learned register	28. Risk report
11. Change management plan	11. Milestone list	29. Schedule data
12. Configuration management plan	12. Physical resource assignments	30. Schedule forecasts
13. Scope baseline	13. Project calendars	31. Stakeholder register
14. Schedule baseline	14. Project communications	32. Team charter
15. Cost baseline	15. Project schedule	33. Test and evaluation documents
16. Performance measurement baseline	16. Project schedule network diagram	
17. Project life cycle description	17. Project scope statement	
18. Development approach	18. Project team assignments	



4.3 DIRECT AND MANAGE PROJECT WORK

Direct and Manage Project Work is the process of leading and performing the work defined in the project management plan and implementing approved changes to achieve the project’s objectives. The key benefit of this process is that it provides overall management of the project work and deliverables, thus improving the probability of project success. This process is performed throughout the project. The inputs, tools and techniques, and outputs of the process are depicted in Figure 4-6. Figure 4-7 depicts the data flow diagram for the process.

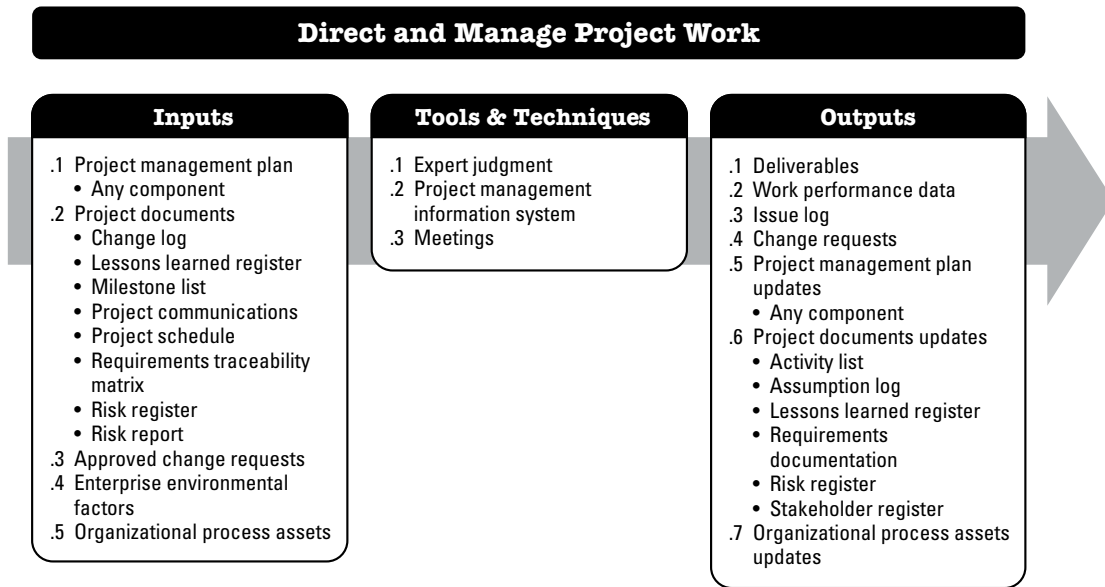

Figure 4-6. Direct and Manage Project Work: Inputs, Tools & Techniques, and Outputs

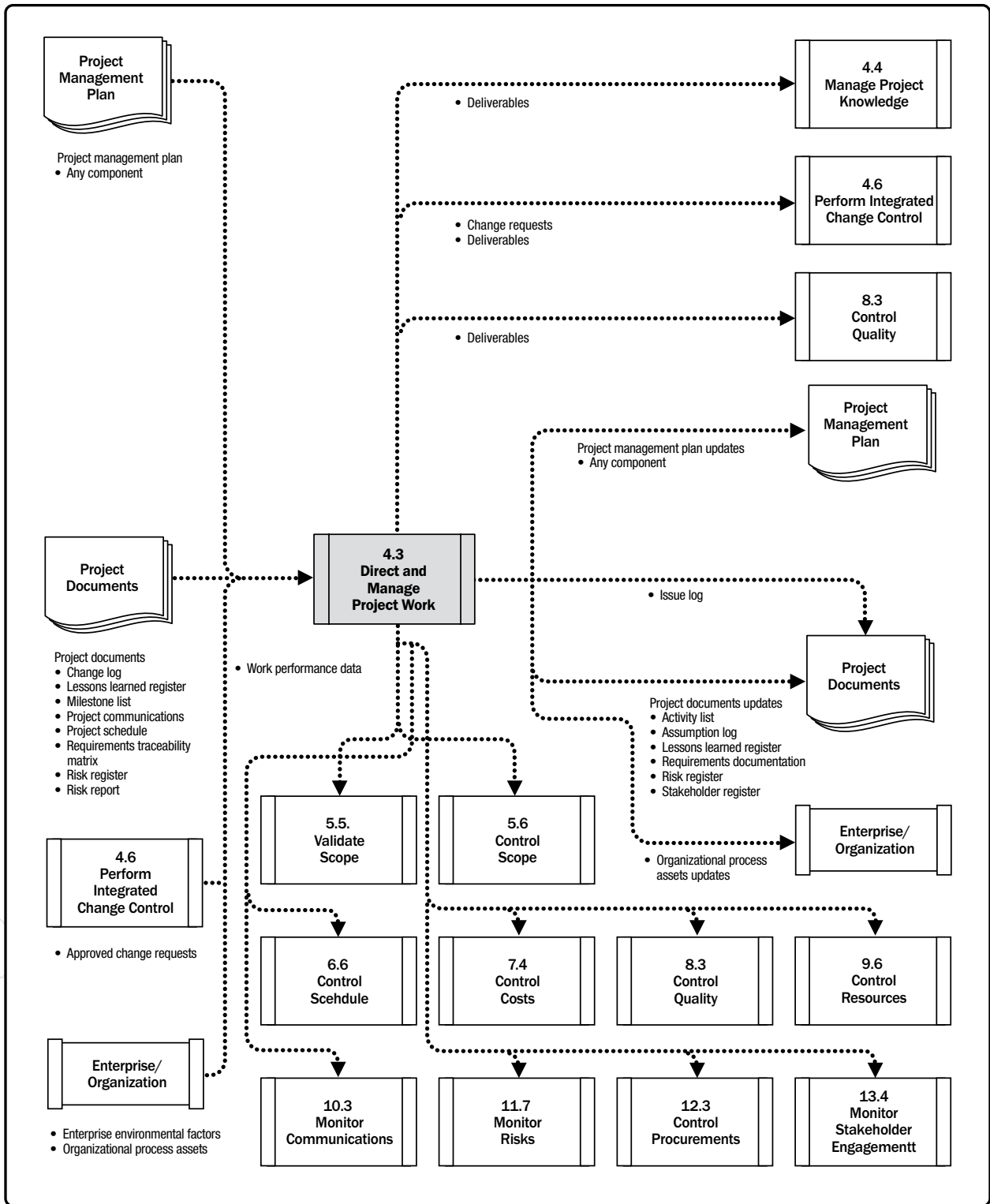

Figure 4-7. Direct and Manage Project Work: Data Flow Diagram

Direct and Manage Project Work involves executing the planned project activities to complete project deliverables and accomplish established objectives. Available resources are allocated, their efficient use is managed, and changes in project plans stemming from analyzing work performance data and information are carried out. The Direct and Manage Project Work process is directly affected by the project application area. Deliverables are produced as outputs from processes performed to accomplish the project work as planned and scheduled in the project management plan.

The project manager, along with the project management team, directs the performance of the planned project activities and manages the various technical and organizational interfaces that exist in the project. Direct and Manage Project Work also requires review of the impact of all project changes and the implementation of approved changes: corrective action, preventive action, and/or defect repair.

During project execution, the work performance data is collected and communicated to the applicable controlling processes for analysis. Work performance data analysis provides information about the completion status of deliverables and other relevant details about project performance. The work performance data will also be used as an input to the Monitoring and Controlling Process Group, and can be used as feedback into lessons learned to improve the performance of future work packages.

4.3.1 DIRECT AND MANAGE PROJECT WORK: INPUTS

4.3.1.1 PROJECT MANAGEMENT PLAN

Described in Section 4.2.3.1. Any component of the project management plan may be an input to this process.

4.3.1.2 PROJECT DOCUMENTS

Project documents that can be considered as inputs for this process include but are not limited to:

- ◆ **Change log.** Described in Section 4.6.3.3. The change log contains the status of all change requests.
- ◆ **Lessons learned register.** Described in Section 4.4.3.1. Lessons learned are used to improve the performance of the project and to avoid repeating mistakes. The register helps identify where to set rules or guidelines so the team's actions are aligned.
- ◆ **Milestone list.** Described in Section 6.2.3.3. The milestone list shows the scheduled dates for specific milestones.
- ◆ **Project communications.** Described in Section 10.2.3.1. Project communications include performance reports, deliverable status, and other information generated by the project.

- ◆ **Project schedule.** Described in Section 6.5.3.2. The schedule includes at least the list of work activities, their durations, resources, and planned start and finish dates.
- ◆ **Requirements traceability matrix.** Described in Section 5.2.3.2. The requirements traceability matrix links product requirements to the deliverables that satisfy them and helps to focus on the final outcomes.
- ◆ **Risk register.** Described in Section 11.2.3.1. The risk register provides information on threats and opportunities that may impact project execution.
- ◆ **Risk report.** Described in Section 11.2.3.2. The risk report provides information on sources of overall project risk along with summary information on identified individual project risks.

4.3.1.3 APPROVED CHANGE REQUESTS

Described in Section 4.6.3.1. Approved change requests are an output of the Perform Integrated Change Control process, and include those requests reviewed and approved for implementation by the project manager or by the change control board (CCB) when applicable. The approved change request may be a corrective action, a preventive action, or a defect repair. Approved change requests are scheduled and implemented by the project team and can impact any area of the project or project management plan. The approved change requests can also modify the formally controlled project management plan components or project documents.

4.3.1.4 ENTERPRISE ENVIRONMENTAL FACTORS

The enterprise environmental factors that can influence the Direct and Manage Project Work process include but are not limited to:

- ◆ Organizational structure, culture, management practices, and sustainability;
- ◆ Infrastructure (e.g., existing facilities and capital equipment); and
- ◆ Stakeholder risk thresholds (e.g., allowable cost overrun percentage).



4.3.1.5 ORGANIZATIONAL PROCESS ASSETS

The organizational process assets that can influence the Direct and Manage Project Work process include but are not limited to:

- ◆ Organizational standard policies, processes, and procedures;
- ◆ Issue and defect management procedures defining issue and defect controls, issue and defect identification and resolution, and action item tracking;
- ◆ Issue and defect management database(s) containing historical issue and defect status, issue and defect resolution, and action item results;
- ◆ Performance measurement database used to collect and make available measurement data on processes and products;
- ◆ Change control and risk control procedures; and
- ◆ Project information from previous projects (e.g., scope, cost, schedule, performance measurement baselines, project calendars, project schedule network diagrams, risk registers, risk reports, and lessons learned repository).

4.3.2 DIRECT AND MANAGE PROJECT WORK: TOOLS AND TECHNIQUES

4.3.2.1 EXPERT JUDGMENT

Described in Section 4.1.2.1. Expertise should be considered from individuals or groups with specialized knowledge or training in the following topics:

- ◆ Technical knowledge on the industry and focus area of the project,
- ◆ Cost and budget management,
- ◆ Legal and procurement,
- ◆ Legislation and regulations, and
- ◆ Organizational governance.

4.3.2.2 PROJECT MANAGEMENT INFORMATION SYSTEM (PMIS)

The PMIS provides access to information technology (IT) software tools, such as scheduling software tools, work authorization systems, configuration management systems, information collection and distribution systems, as well as interfaces to other online automated systems such as corporate knowledge base repositories. Automated gathering and reporting on key performance indicators (KPI) can be part of this system.

4.3.2.3 MEETINGS

Meetings are used to discuss and address pertinent topics of the project when directing and managing project work. Attendees may include the project manager, the project team, and appropriate stakeholders involved or affected by the topics addressed. Each attendee should have a defined role to ensure appropriate participation. Types of meetings include but are not limited to: kick-off, technical, sprint or iteration planning, Scrum daily standups, steering group, problem solving, progress update, and retrospective meetings.

4.3.3 DIRECT AND MANAGE PROJECT WORK: OUTPUTS

4.3.3.1 DELIVERABLES

A deliverable is any unique and verifiable product, result, or capability to perform a service that is required to be produced to complete a process, phase, or project. Deliverables are typically the outcomes of the project and can include components of the project management plan.

Change control should be applied once the first version of a deliverable has been completed. The control of the multiple versions or editions of a deliverable (e.g., documents, software, and building blocks) is supported by configuration management tools and procedures.

4.3.3.2 WORK PERFORMANCE DATA

Work performance data are the raw observations and measurements identified during activities being performed to carry out the project work. Data are often viewed as the lowest level of detail from which information is derived by other processes. Data is gathered through work execution and passed to the controlling processes for further analysis.

Examples of work performance data include work completed, key performance indicators (KPIs), technical performance measures, actual start and finish dates of schedule activities, story points completed, deliverables status, schedule progress, number of change requests, number of defects, actual costs incurred, actual durations, etc.

4.3.3.3 ISSUE LOG

Throughout the life cycle of a project, the project manager will normally face problems, gaps, inconsistencies, or conflicts that occur unexpectedly and that require some action so they do not impact the project performance. The issue log is a project document where all the issues are recorded and tracked. Data on issues may include:

- ◆ Issue type,
- ◆ Who raised the issue and when,
- ◆ Description,
- ◆ Priority,
- ◆ Who is assigned to the issue,
- ◆ Target resolution date,
- ◆ Status, and
- ◆ Final solution.

The issue log will help the project manager effectively track and manage issues, ensuring that they are investigated and resolved. The issue log is created for the first time as an output of this process, although issues may happen at any time during the project. The issue log is updated as a result of the monitoring and control activities throughout the project's life cycle.

4.3.3.4 CHANGE REQUESTS

A change request is a formal proposal to modify any document, deliverable, or baseline. When issues are found while project work is being performed, change requests can be submitted, which may modify project policies or procedures, project or product scope, project cost or budget, project schedule, or quality of the project or product results. Other change requests cover the needed preventive or corrective actions to forestall negative impact later in the project. Any project stakeholder may request a change. Change requests are processed for review and disposition through the Perform Integrated Change Control process (Section 4.6). Change requests can be initiated from inside or outside the project and they can be optional or legally/contractually mandated. Change requests may include:

- ◆ **Corrective action.** An intentional activity that realigns the performance of the project work with the project management plan.
- ◆ **Preventive action.** An intentional activity that ensures the future performance of the project work is aligned with the project management plan.
- ◆ **Defect repair.** An intentional activity to modify a nonconforming product or product component.
- ◆ **Updates.** Changes to formally controlled project documents, plans, etc., to reflect modified or additional ideas or content.

4.3.3.5 PROJECT MANAGEMENT PLAN UPDATES

Any change to the project management plan goes through the organization's change control process via a change request. Any component of the project management plan may require a change request as a result of this process.

4.3.3.6 PROJECT DOCUMENTS UPDATES

Project documents that may be updated as a result of carrying out this process include but are not limited to:

- ◆ **Activity list.** Described in Section 6.2.3.1. The activity list may be updated with additional or modified activities to be performed to complete project work.
- ◆ **Assumption log.** Described in Section 4.1.3.2. New assumptions and constraints may be added, and the status of existing assumptions and constraints may be updated or closed out.
- ◆ **Lessons learned register.** Described in Section 4.4.3.1. Any lessons learned that will improve performance for current or future projects is recorded as it is learned.
- ◆ **Requirements documentation.** Described in Section 5.2.3.1. New requirements may be identified during this process. Progress on meeting requirements can also be updated.
- ◆ **Risk register.** Described in Section 11.2.3.1. New risks may be identified and existing risks may be updated during this process. Risks are recorded in the risk register via risk management processes.
- ◆ **Stakeholder register.** Described in Section 13.1.3.1. Where additional information on existing or new stakeholders is gathered as a result of this process, it is recorded in the stakeholder register.

4.3.3.7 ORGANIZATIONAL PROCESS ASSETS UPDATES

Any organizational process asset can be updated as a result of this process.

4.4 MANAGE PROJECT KNOWLEDGE

Manage Project Knowledge is the process of using existing knowledge and creating new knowledge to achieve the project's objectives and contribute to organizational learning. The key benefits of this process are that prior organizational knowledge is leveraged to produce or improve the project outcomes, and knowledge created by the project is available to support organizational operations and future projects or phases. This process is performed throughout the project. The inputs, tools and techniques, and outputs of the process are depicted in Figure 4-8. Figure 4-9 depicts the data flow diagram for the process.

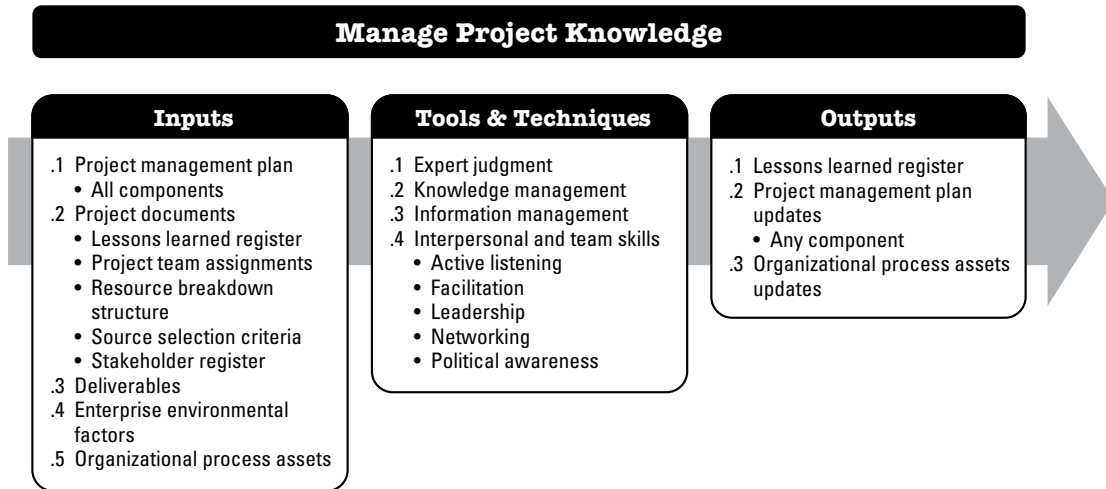

Figure 4-8. Manage Project Knowledge: Inputs, Tools & Techniques, and Outputs

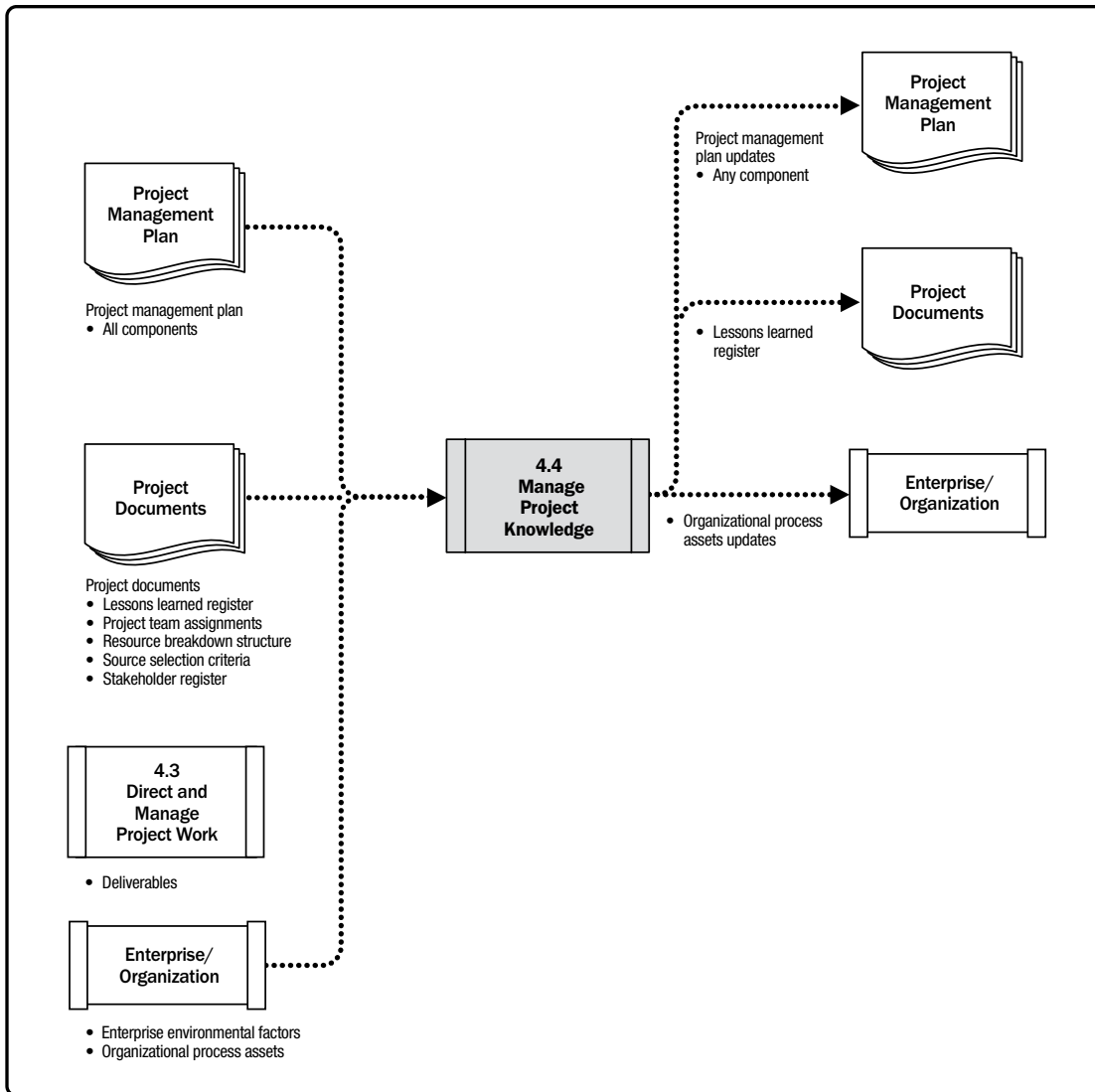

Figure 4-9. Manage Project Knowledge: Data Flow Diagram

Knowledge is commonly split into “explicit” (knowledge that can be readily codified using words, pictures, and numbers) and “tacit” (knowledge that is personal and difficult to express, such as beliefs, insights, experience, and “know-how”). Knowledge management is concerned with managing both tacit and explicit knowledge for two purposes: reusing existing knowledge and creating new knowledge. The key activities that underpin both purposes are knowledge sharing and knowledge integration (of knowledge from different domains, contextual knowledge, and project management knowledge).

It is a common misconception that managing knowledge involves just documenting it so it can be shared. Another common misconception is that managing knowledge involves just obtaining lessons learned at the end of the project, in order to use it in the future projects. Only codified explicit knowledge can be shared in this way. But codified explicit knowledge lacks context and is open to different interpretations, so even though it can easily be shared, it isn’t always understood or applied in the right way. Tacit knowledge has context built in but is very difficult to codify. It resides in the minds of individual experts or in social groups and situations, and is normally shared through conversations and interactions between people.

From an organizational perspective, knowledge management is about making sure the skills, experience, and expertise of the project team and other stakeholders are used before, during, and after the project. Because knowledge resides in the minds of people and people cannot be forced to share what they know (or to pay attention to others’ knowledge), the most important part of knowledge management is creating an atmosphere of trust so that people are motivated to share their knowledge. Even the best knowledge management tools and techniques will not work if people are not motivated to share what they know or to pay attention to what others know. In practice, knowledge is shared using a mixture of knowledge management tools and techniques (interactions between people) and information management tools and techniques (in which people codify part of their explicit knowledge by documenting it so it can be shared).

4.4.1 MANAGE PROJECT KNOWLEDGE: INPUTS

4.4.1.1 PROJECT MANAGEMENT PLAN

Described in Section 4.2.3.1. All components of the project management plan are inputs.

4.4.1.2 PROJECT DOCUMENTS

Project documents that can be considered as inputs for this process include but are not limited to:

- ◆ **Lessons learned register.** Described in Section 4.4.3.1. The lessons learned register provides information on effective practices in knowledge management.
- ◆ **Project team assignments.** Described in Section 9.3.3.1. Project team assignments provide information on the type of competencies and experience available in the project and the knowledge that may be missing.
- ◆ **Resource breakdown structure.** Described in Section 9.2.3.3. The resource breakdown structure includes information on the composition of the team and may help to understand what knowledge is available as a group and what knowledge is missing.
- ◆ **Stakeholder register.** Described in Section 13.1.3.1. The stakeholder register contains details about the identified stakeholders to help understand the knowledge they may have.

4.4.1.3 DELIVERABLES

A deliverable is any unique and verifiable product, result, or capability to perform a service that is required to be produced to complete a process, phase, or project. Deliverables are typically tangible components completed to meet the project objectives and can include components of the project management plan.

4.4.1.4 ENTERPRISE ENVIRONMENTAL FACTORS

The enterprise environmental factors that can influence the Manage Project Knowledge process include but are not limited to:

- ◆ **Organizational, stakeholder, and customer culture.** The existence of trusting working relationships and a no-blame culture is particularly important in managing knowledge. Other factors include the value placed on learning and social behavioral norms.
- ◆ **Geographic distribution of facilities and resources.** The location of team members helps determine methods for gaining and sharing knowledge.
- ◆ **Organizational knowledge experts.** Some organizations have a team or individual that specializes in knowledge management.
- ◆ **Legal and regulatory requirements and/or constraints.** These include confidentiality of project information.

4.4.1.5 ORGANIZATIONAL PROCESS ASSETS

Knowledge about project management is often embedded in processes and routines. The organizational process assets that can influence the Manage Project Knowledge process include but are not limited to:

- ◆ **Organizational standard policies, processes, and procedures.** These may include: confidentiality and access to information; security and data protection; record retention policies; use of copyrighted information; destruction of classified information; format and maximum size of files; registry data and metadata; authorized technology and social media; etc.
- ◆ **Personnel administration.** These include, for example, employee development and training records, and competency frameworks that refer to knowledge-sharing behaviors.
- ◆ **Organizational communication requirements.** Formal, rigid communication requirements are good for sharing information. Informal communication is more effective for creating new knowledge and integrating knowledge across diverse stakeholder groups.
- ◆ **Formal knowledge-sharing and information-sharing procedures.** These include learning reviews before, during, and after projects and project phases; for example, identifying, capturing, and sharing lessons learned from the current project and other projects.

4.4.2 MANAGE PROJECT KNOWLEDGE: TOOLS AND TECHNIQUES

4.4.2.1 EXPERT JUDGMENT

Described in Section 4.1.2.1. Expertise should be considered from individuals or groups with specialized knowledge or training in the following topics:

- ◆ Knowledge management,
- ◆ Information management,
- ◆ Organizational learning,
- ◆ Knowledge and information management tools, and
- ◆ Relevant information from other projects.

4.4.2.2 KNOWLEDGE MANAGEMENT

Knowledge management tools and techniques connect people so they can work together to create new knowledge, share tacit knowledge, and integrate the knowledge of diverse team members. The tools and techniques appropriate in a project depend on the nature of the project, especially the degree of innovation involved, the project complexity, and the level of diversity (including diversity of disciplines) among team members.

Tools and techniques include but are not limited to:

- ◆ Networking, including informal social interaction and online social networking. Online forums where people can ask open questions (“What does anyone know about...?”) are useful for starting knowledge-sharing conversations with specialists;
- ◆ Communities of practice (sometimes called communities of interest or just communities) and special interest groups;
- ◆ Meetings, including virtual meetings where participants can interact using communications technology;
- ◆ Work shadowing and reverse shadowing;
- ◆ Discussion forums such as focus groups;
- ◆ Knowledge-sharing events such as seminars and conferences;
- ◆ Workshops, including problem-solving sessions and learning reviews designed to identify lessons learned;
- ◆ Storytelling;
- ◆ Creativity and ideas management techniques;
- ◆ Knowledge fairs and cafés; and
- ◆ Training that involves interaction between learners.

All of these tools and techniques can be applied face-to-face or virtually, or both. Face-to-face interaction is usually the most effective way to build the trusting relationships that are needed to manage knowledge. Once relationships are established, virtual interaction can be used to maintain the relationship.

4.4.2.3 INFORMATION MANAGEMENT

Information management tools and techniques are used to create and connect people to information. They are effective for sharing simple, unambiguous, codified explicit knowledge. They include but are not limited to:

- ◆ Methods for codifying explicit knowledge; for example, for producing lessons to be learned entries for the lessons learned register;
- ◆ Lessons learned register;
- ◆ Library services;
- ◆ Information gathering, for example, web searches and reading published articles; and
- ◆ Project management information system (PMIS). Described in Section 4.3.2.2. Project management information systems often include document management systems.

Tools and techniques that connect people to information can be enhanced by adding an element of interaction, for example, include a “contact me” function so users can get in touch with the originators of the lessons and ask for advice specific to their project and context.

Interaction and support also helps people find relevant information. Asking for help is generally quicker and easier than trying to identify search terms. Search terms are often difficult to select because people may not know which keywords or key phrases to use to access the information they need.

Knowledge and information management tools and techniques should be connected to project processes and process owners. Communities of practice and subject matter experts (SMEs), for example, may generate insights that lead to improved control processes; having an internal sponsor can ensure improvements are implemented. Lessons learned register entries may be analyzed to identify common issues that can be addressed by changes to project procedures.

4.4.2.4 INTERPERSONAL AND TEAM SKILLS

The interpersonal and team skills used include but are not limited to:

- ◆ **Active listening.** Described in Section 10.2.2.6. Active listening helps reduce misunderstandings and improves communication and knowledge sharing.
- ◆ **Facilitation.** Described in Section 4.1.2.3. Facilitation helps effectively guide a group to a successful decision, solution, or conclusion.
- ◆ **Leadership.** Described in Section 3.4.4. Leadership is used to communicate the vision and inspire the project team to focus on the appropriate knowledge and knowledge objectives.
- ◆ **Networking.** Described in Section 10.2.2.6. Networking allows informal connections and relations among project stakeholders to be established and creates the conditions to share tacit and explicit knowledge.
- ◆ **Political awareness.** Described in Section 10.1.2.6. Political awareness helps the project manager to plan communications based on the project environment as well as the organization's political environment.

4.4.3 MANAGE PROJECT KNOWLEDGE: OUTPUTS

4.4.3.1 LESSONS LEARNED REGISTER

The lessons learned register can include the category and description of the situation. The lessons learned register may also include the impact, recommendations, and proposed actions associated with the situation. The lessons learned register may record challenges, problems, realized risks and opportunities, or other content as appropriate.

The lessons learned register is created as an output of this process early in the project. Thereafter it is used as an input and updated as an output in many processes throughout the project. The persons or teams involved in the work are also involved in capturing the lessons learned. Knowledge can be documented using videos, pictures, audios, or other suitable means that ensure the efficiency of the lessons captured.

At the end of a project or phase, the information is transferred to an organizational process asset called a lessons learned repository.

4.4.3.2 PROJECT MANAGEMENT PLAN UPDATES

Any change to the project management plan goes through the organization's change control process via a change request. Any component of the project management plan may be updated as a result of this process.

4.4.3.3 ORGANIZATIONAL PROCESS ASSETS UPDATES

All projects create new knowledge. Some of this knowledge is codified, embedded in deliverables, or embedded in improvements to processes and procedures as a result of the Manage Project Knowledge process. Existing knowledge can also be codified or embedded for the first time as a result of this process; for example, if an existing idea for a new procedure is piloted in the project and found to be successful.

Any organizational process asset can be updated as a result of this process.

4.5 MONITOR AND CONTROL PROJECT WORK

Monitor and Control Project Work is the process of tracking, reviewing, and reporting the overall progress to meet the performance objectives defined in the project management plan. The key benefits of this process are that it allows stakeholders to understand the current state of the project, to recognize the actions taken to address any performance issues, and to have visibility into the future project status with cost and schedule forecasts. This process is performed throughout the project. The inputs, tools and techniques, and outputs of the process are depicted in Figure 4-10. Figure 4-11 depicts the data flow diagram for the process.

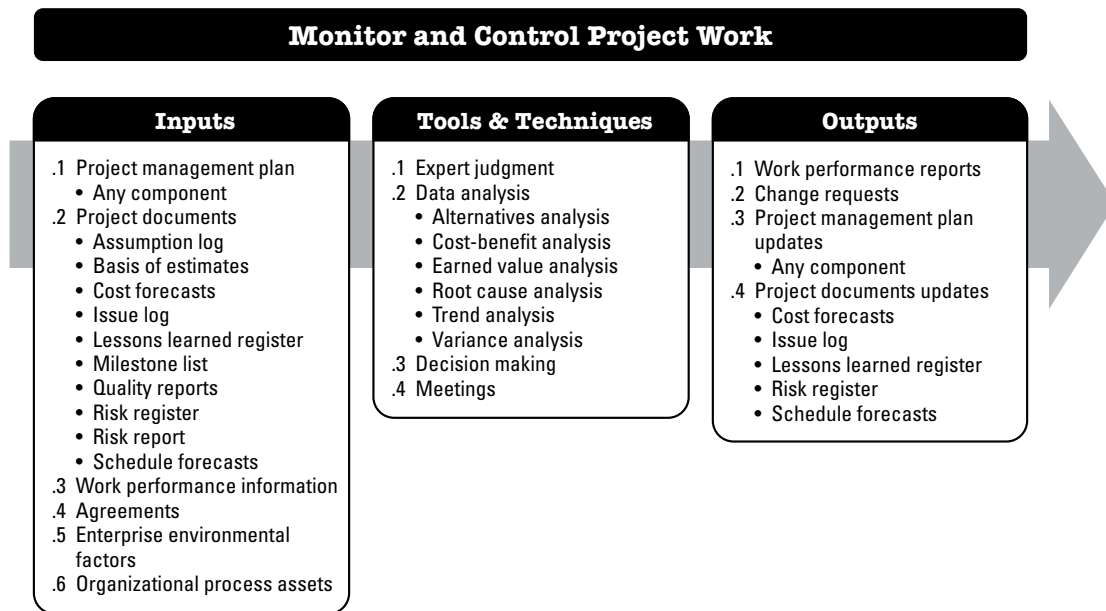

Figure 4-10. Monitor and Control Project Work: Inputs, Tools & Techniques, and Outputs

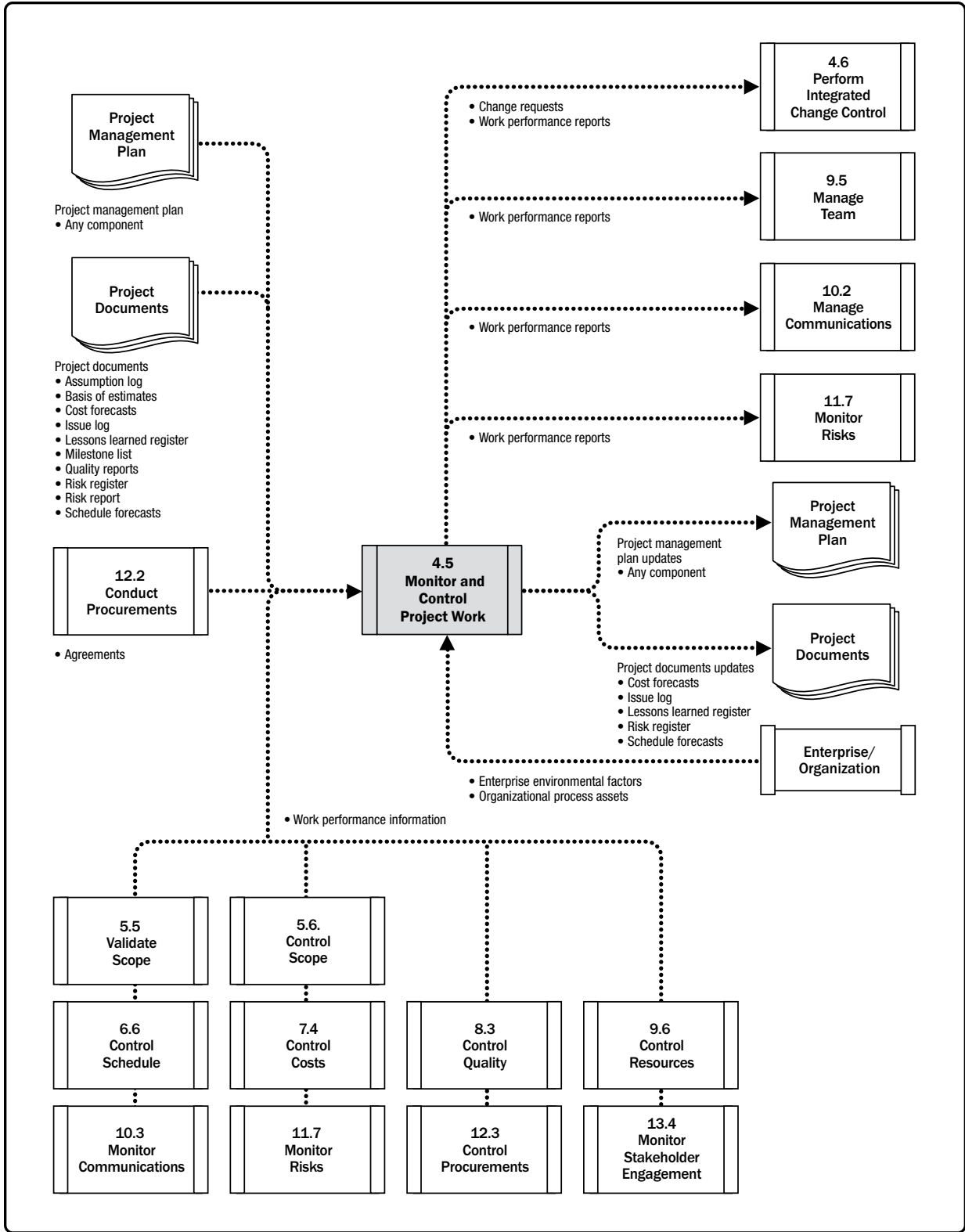

Figure 4-11. Monitor and Control Project Work: Data Flow Diagram

Monitoring is an aspect of project management performed throughout the project. Monitoring includes collecting, measuring, and assessing measurements and trends to effect process improvements. Continuous monitoring gives the project management team insight into the health of the project and identifies any areas that may require special attention. Control includes determining corrective or preventive actions or replanning and following up on action plans to determine whether the actions taken resolved the performance issue. The Monitor and Control Project Work process is concerned with:

- ◆ Comparing actual project performance against the project management plan;
- ◆ Assessing performance periodically to determine whether any corrective or preventive actions are indicated, and then recommending those actions as necessary;
- ◆ Checking the status of individual project risks;
- ◆ Maintaining an accurate, timely information base concerning the project's product(s) and their associated documentation through project completion;
- ◆ Providing information to support status reporting, progress measurement, and forecasting;
- ◆ Providing forecasts to update current cost and current schedule information;
- ◆ Monitoring implementation of approved changes as they occur;
- ◆ Providing appropriate reporting on project progress and status to program management when the project is part of an overall program; and
- ◆ Ensuring that the project stays aligned with the business needs.

4.5.1 MONITOR AND CONTROL PROJECT WORK: INPUTS

4.5.1.1 PROJECT MANAGEMENT PLAN

Described in Section 4.2.3.1. Monitoring and controlling project work involves looking at all aspects of the project. Any component of the project management plan may be an input for this process.



4.5.1.2 PROJECT DOCUMENTS

Project documents that can be considered as inputs for this process include but are not limited to:

- ◆ **Assumption log.** Described in Section 4.1.3.2. The assumption log contains information about assumptions and constraints identified as affecting the project.
- ◆ **Basis of estimates.** Described in Sections 6.4.3.2 and 7.2.3.2. Basis of estimates indicates how the various estimates were derived and can be used to make a decision on how to respond to variances.
- ◆ **Cost forecasts.** Described in Section 7.4.3.2. Based on the project's past performance, the cost forecasts are used to determine if the project is within defined tolerance ranges for budget and to identify any necessary change requests.
- ◆ **Issue log.** Described in Section 4.3.3.3. The issue log is used to document and monitor who is responsible for resolving specific issues by a target date.
- ◆ **Lessons learned register.** Described in Section 4.4.3.1. The lessons learned register may have information on effective responses for variances, and corrective and preventive actions.
- ◆ **Milestone list.** Described in Section 6.2.3.3. The milestone list shows the scheduled dates for specific milestones and is used to check if the planned milestones have been met.
- ◆ **Quality reports.** Described in Section 8.2.3.1. The quality report includes quality management issues; recommendations for process, project, and product improvements; corrective actions recommendations (includes rework, defect/bugs repair, 100% inspection, and more); and the summary of findings from the Control Quality process.
- ◆ **Risk register.** Described in Section 11.2.3.1. The risk register provides information on threats and opportunities that have occurred during project execution.
- ◆ **Risk report.** Described in Section 11.2.3.2. The risk report provides information on the overall project risks as well as information on specified individual risks.
- ◆ **Schedule forecasts.** Described in Section 6.6.3.2. Based on the project's past performance, the schedule forecasts are used to determine if the project is within defined tolerance ranges for schedule and to identify any necessary change requests.

4.5.1.3 WORK PERFORMANCE INFORMATION

Work performance data is gathered through work execution and passed to the controlling processes. To become work performance information, the work performance data are compared with the project management plan components, project documents, and other project variables. This comparison indicates how the project is performing.

Specific work performance metrics for scope, schedule, budget, and quality are defined at the start of the project as part of the project management plan. Performance data are collected during the project through the controlling processes and compared to the plan and other variables to provide a context for work performance.

For example, work performance data on cost may include funds that have been expended. However, to be useful, that data has to be compared to the budget, the work that was performed, the resources used to accomplish the work, and the funding schedule. This additional information provides the context to determine if the project is on budget or if there is a variance. It also indicates the degree of variance from the plan, and by comparing it to the variance thresholds in the project management plan it can indicate if preventive or corrective action is required. Interpreting work performance data and the additional information as a whole provides a context that provides a sound foundation for project decisions.

4.5.1.4 AGREEMENTS

Described in Section 12.2.3.2. A procurement agreement includes terms and conditions, and may incorporate other items that the buyer specifies regarding what the seller is to perform or provide. If the project is outsourcing part of the work, the project manager needs to oversee the contractor's work to make certain that all the agreements meet the specific needs of the project while adhering to organizational procurement policies.

4.5.1.5 ENTERPRISE ENVIRONMENTAL FACTORS

The enterprise environmental factors that can influence the Monitor and Control Project Work process include but are not limited to:

- ◆ Project management information systems such as scheduling, cost, resourcing tools, performance indicators, databases, project records, and financials;
- ◆ Infrastructure (e.g., existing facilities and equipment, organization's telecommunications channels);
- ◆ Stakeholders' expectations and risk thresholds; and
- ◆ Government or industry standards (e.g., regulatory agency regulations, product standards, quality standards, and workmanship standards).

4.5.1.6 ORGANIZATIONAL PROCESS ASSETS

The organizational process assets that can influence the Monitor and Control Project Work process include but are not limited to:

- ◆ Organizational standard policies, processes, and procedures;
- ◆ Financial controls procedures (e.g., required expenditure and disbursement reviews, accounting codes, and standard contract provisions);
- ◆ Monitoring and reporting methods;
- ◆ Issue management procedures defining issue controls, issue identification, and resolution and action item tracking;
- ◆ Defect management procedures defining defect controls, defect identification, and resolution and action item tracking; and
- ◆ Organizational knowledge base, in particular process measurement and the lessons learned repository.

4.5.2 MONITOR AND CONTROL PROJECT WORK: TOOLS AND TECHNIQUES

4.5.2.1 EXPERT JUDGMENT

Described in Section 4.1.2.1. Expertise should be considered from individuals or groups with specialized knowledge or training in the following topics:

- ◆ Earned value analysis,
- ◆ Interpretation and contextualization of data,
- ◆ Techniques to estimate duration and costs,
- ◆ Trend analysis,
- ◆ Technical knowledge on the industry and focus area of the project,
- ◆ Risk management, and
- ◆ Contract management.

4.5.2.2 DATA ANALYSIS

Data analysis techniques that can be used include but are not limited to:

- ◆ **Alternatives analysis.** Alternatives analysis is used to select the corrective actions or a combination of corrective and preventive actions to implement when a deviation occurs.
- ◆ **Cost-benefit analysis.** Described in Section 8.1.2.3. Cost-benefit analysis helps to determine the best corrective action in terms of cost in case of project deviations.
- ◆ **Earned value analysis.** Described in Section 7.4.2.2. Earned value provides an integrated perspective on scope, schedule, and cost performance.
- ◆ **Root cause analysis.** Described in Section 8.2.2.2. Root cause analysis focuses on identifying the main reasons of a problem. It can be used to identify the reasons for a deviation and the areas the project manager should focus on in order to achieve the objectives of the project.
- ◆ **Trend analysis.** Trend analysis is used to forecast future performance based on past results. It looks ahead in the project for expected slippages and warns the project manager ahead of time that there may be problems later in the schedule if established trends persist. This information is made available early enough in the project timeline to give the project team time to analyze and correct any anomalies. The results of trend analysis can be used to recommend preventive actions if necessary.
- ◆ **Variance analysis.** Variance analysis reviews the differences (or variance) between planned and actual performance. This can include duration estimates, cost estimates, resources utilization, resources rates, technical performance, and other metrics.

Variance analysis may be conducted in each Knowledge Area based on its particular variables. In Monitor and Control Project Work, the variance analysis reviews the variances from an integrated perspective considering cost, time, technical, and resource variances in relation to each other to get an overall view of variance on the project. This allows for the appropriate preventive or corrective actions to be initiated.

4.5.2.3 DECISION MAKING

A decision-making technique that can be used includes but is not limited to voting. Described in Section 5.2.2.4. Voting can include making decisions based on unanimity, majority, or plurality.

4.5.2.4 MEETINGS

Meetings may be face-to-face, virtual, formal, or informal. They may include project team members and other project stakeholders when appropriate. Types of meetings include but are not limited to user groups and review meetings.

4.5.3 MONITOR AND CONTROL PROJECT WORK: OUTPUTS

4.5.3.1 WORK PERFORMANCE REPORTS

Work performance information is combined, recorded, and distributed in a physical or electronic form in order to create awareness and generate decisions or actions. Work performance reports are the physical or electronic representation of work performance information intended to generate decisions, actions, or awareness. They are circulated to the project stakeholders through the communication processes as defined in the project communications management plan.

Examples of work performance reports include status reports and progress reports. Work performance reports can contain earned value graphs and information, trend lines and forecasts, reserve burndown charts, defect histograms, contract performance information, and risk summaries. They can be presented as dashboards, heat reports, stop light charts, or other representations useful for creating awareness and generating decisions and actions.

4.5.3.2 CHANGE REQUESTS

Described in Section 4.3.3.4. As a result of comparing planned results to actual results, change requests may be issued to expand, adjust, or reduce project scope, product scope, or quality requirements and schedule or cost baselines. Change requests may necessitate the collection and documentation of new requirements. Changes can impact the project management plan, project documents, or product deliverables. Change requests are processed for review and disposition through the Perform Integrated Change Control process (Section 4.6). Changes may include but are not limited to:

- ◆ **Corrective action.** An intentional activity that realigns the performance of the project work with the project management plan.
- ◆ **Preventive action.** An intentional activity that ensures the future performance of the project work is aligned with the project management plan.
- ◆ **Defect repair.** An intentional activity that modifies a nonconforming product or product component.

4.5.3.3 PROJECT MANAGEMENT PLAN UPDATES

Any change to the project management plan goes through the organization's change control process via a change request. Changes identified during the Monitor and Control Project Work process may affect the overall project management plan.

4.5.3.4 PROJECT DOCUMENTS UPDATES

Project documents that may be updated as a result of carrying out this process include but are not limited to:

- ◆ **Cost forecasts.** Described in Section 7.4.3.2. Changes in cost forecasts resulting from this process are recorded using cost management processes.
- ◆ **Issue log.** Described in Section 4.3.3.3. New issues raised as a result of this process are recorded in the issue log.
- ◆ **Lessons learned register.** Described in Section 4.4.3.1. The lessons learned register is updated with effective responses for variances and corrective and preventive actions.
- ◆ **Risk register.** Described in Section 11.2.3.1. New risks identified during this process are recorded in the risk register and managed using the risk management processes.
- ◆ **Schedule forecasts.** Described in Section 6.6.3.2. Changes in schedule forecasts resulting from this process are recorded using schedule management processes.

4.6 PERFORM INTEGRATED CHANGE CONTROL

Perform Integrated Change Control is the process of reviewing all change requests; approving changes and managing changes to deliverables, project documents, and the project management plan; and communicating the decisions. This process reviews all requests for changes to project documents, deliverables, or the project management plan and determines the resolution of the change requests. The key benefit of this process is that it allows for documented changes within the project to be considered in an integrated manner while addressing overall project risk, which often arises from changes made without consideration of the overall project objectives or plans. This process is performed throughout the project. The inputs, tools and techniques, and outputs of the process are depicted in Figure 4-12. Figure 4-13 depicts the data flow diagram for the process.

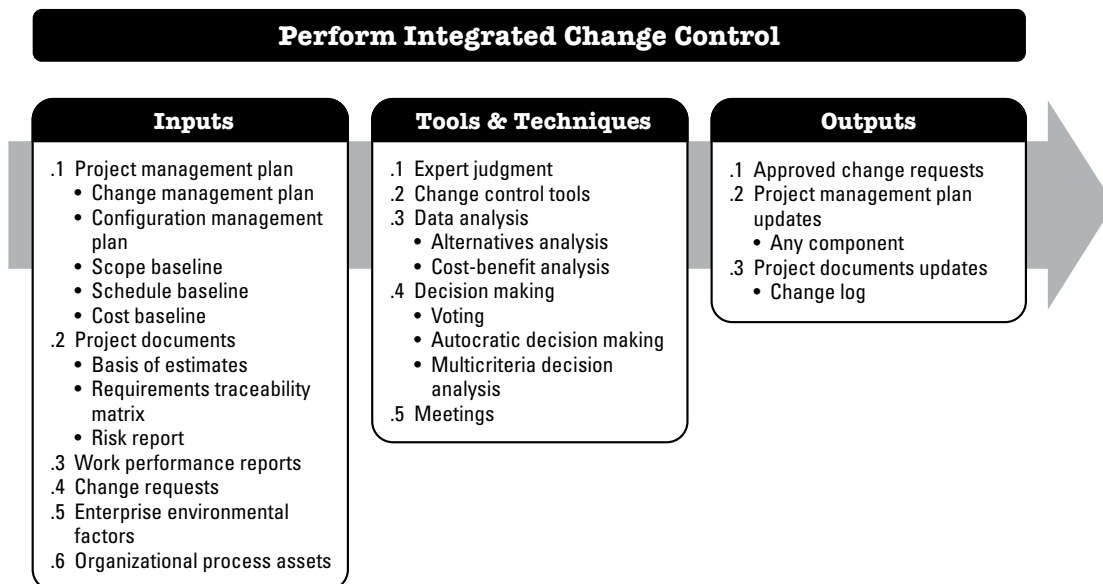

Figure 4-12. Perform Integrated Change Control: Inputs, Tools & Techniques, and Outputs

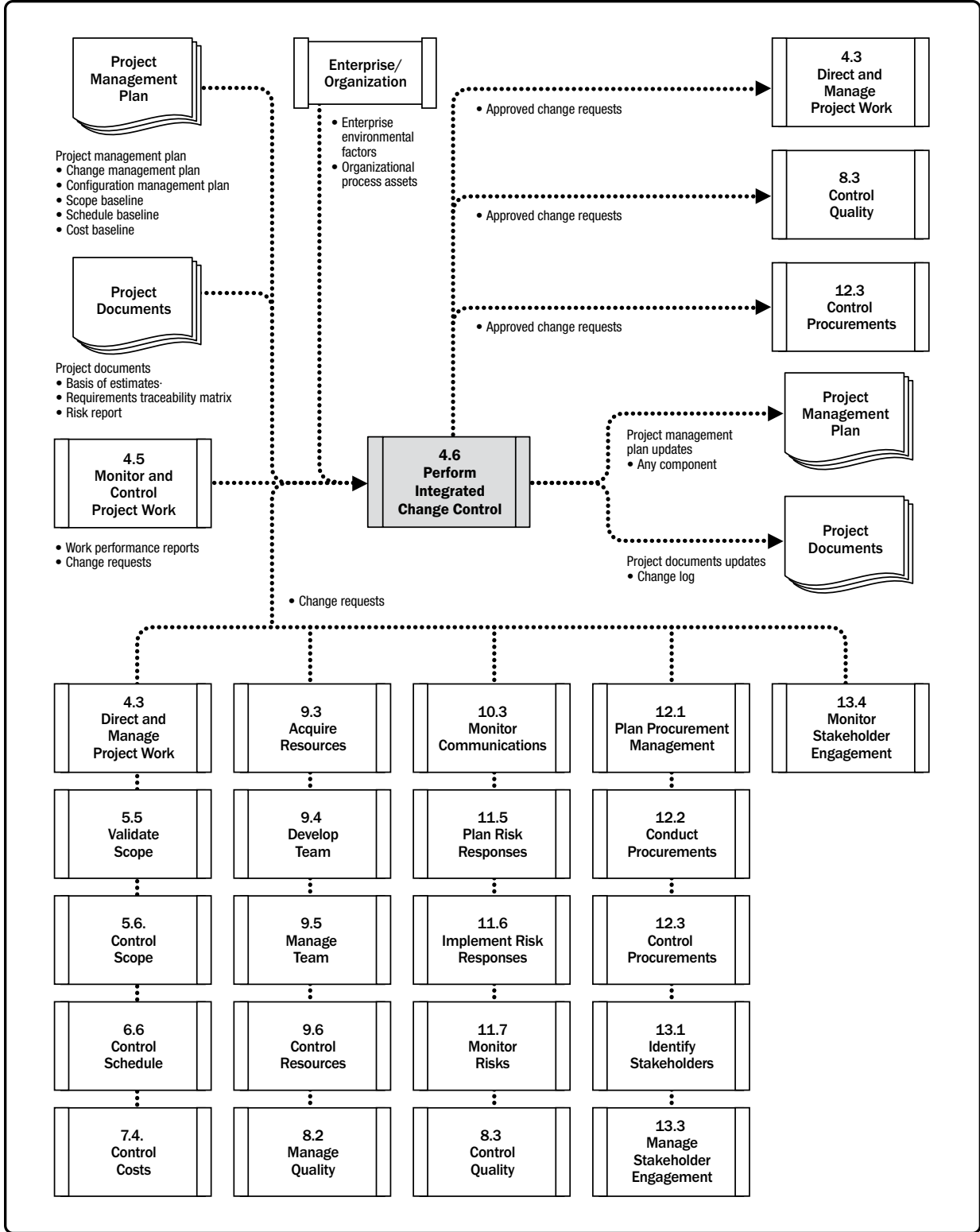

Figure 4-13. Perform Integrated Change Control: Data Flow Diagram

The Perform Integrated Change Control process is conducted from project start through completion and is the ultimate responsibility of the project manager. Change requests can impact the project scope and the product scope, as well as any project management plan component or any project document. Changes may be requested by any stakeholder involved with the project and may occur at any time throughout the project life cycle. The applied level of change control is dependent upon the application area, complexity of the specific project, contract requirements, and the context and environment in which the project is performed.

Before the baselines are established, changes are not required to be formally controlled by the Perform Integrated Change Control process. Once the project is baselined, change requests go through this process. As a general rule, each project's configuration management plan should define which project artifacts need to be placed under configuration control. Any change in a configuration element should be formally controlled and will require a change request.

Although changes may be initiated verbally, they should be recorded in written form and entered into the change management and/or configuration management system. Change requests may require information on estimated schedule impacts and estimated cost impacts prior to approval. Whenever a change request may impact any of the project baselines, a formal integrated change control process is always required. Every documented change request needs to be either approved, deferred, or rejected by a responsible individual, usually the project sponsor or project manager. The responsible individual will be identified in the project management plan or by organizational procedures. When required, the Perform Integrated Change Control process includes a change control board (CCB), which is a formally chartered group responsible for reviewing, evaluating, approving, deferring, or rejecting changes to the project and for recording and communicating such decisions.

Approved change requests can require new or revised cost estimates, activity sequences, schedule dates, resource requirements, and/or analysis of risk response alternatives. These changes can require adjustments to the project management plan and other project documents. Customer or sponsor approval may be required for certain change requests after CCB approval, unless they are part of the CCB.



4.6.1 PERFORM INTEGRATED CHANGE CONTROL: INPUTS

4.6.1.1 PROJECT MANAGEMENT PLAN

Described in Section 4.2.3.1. Project management plan components include but are not limited to:

- ◆ **Change management plan.** Described in Section 4.2.3.1. The change management plan provides the direction for managing the change control process and documents the roles and responsibilities of the change control board (CCB).
- ◆ **Configuration management plan.** Described in Section 4.2.3.1. The configuration management plan describes the configurable items of the project and identifies the items that will be recorded and updated so that the product of the project remains consistent and operable.
- ◆ **Scope baseline.** Described in Section 5.4.3.1. The scope baseline provides the project and product definition.
- ◆ **Schedule baseline.** Described in Section 6.5.3.1. The schedule baseline is used to assess the impact of the changes in the project schedule.
- ◆ **Cost baseline.** Described in Section 7.3.3.1. The cost baseline is used to assess the impact of the changes to the project cost.

4.6.1.2 PROJECT DOCUMENTS

Project documents that can be considered as inputs for this process include but are not limited to:

- ◆ **Basis of estimates.** Described in Section 6.4.3.2. Basis of estimates indicate how the duration, cost, and resources estimates were derived and can be used to calculate the impact of the change in time, budget, and resources.
- ◆ **Requirements traceability matrix.** Described in Section 5.2.3.2. The requirements traceability matrix helps assess the impact of the change on the project scope.
- ◆ **Risk report.** Described in Section 11.2.3.2. The risk report presents information on sources of overall and individual project risks involved by the change requested.

4.6.1.3 WORK PERFORMANCE REPORTS

Described in Section 4.5.3.1. Work performance reports of particular interest to the Perform Integrated Change Control process include resource availability, schedule and cost data, earned value reports, and burnup or burndown charts.

4.6.1.4 CHANGE REQUESTS

Many processes produce change requests as an output. Change requests (described in Section 4.3.3.4) may include corrective action, preventive action, defect repairs, as well as updates to formally controlled documents or deliverables to reflect modified or additional ideas or content. Changes may or may not impact the project baselines—sometimes only the performance against the baseline is affected. Decisions on those changes are usually made by the project manager.

Change requests that have an impact on the project baselines should normally include information about the cost of implementing the change, modifications in the scheduled dates, resource requirements, and risks. These changes should be approved by the CCB (if it exists) and by the customer or sponsor, unless they are part of the CCB. Only approved changes should be incorporated into a revised baseline.

4.6.1.5 ENTERPRISE ENVIRONMENTAL FACTORS

The enterprise environmental factors that can influence the Perform Integrated Change Control process include but are not limited to:

- ◆ Legal restrictions, such as country or local regulations;
- ◆ Government or industry standards (e.g., product standards, quality standards, safety standards, and workmanship standards);
- ◆ Legal and regulatory requirements and/or constraints;
- ◆ Organizational governance framework (a structured way to provide control, direction, and coordination through people, policies, and processes to meet organizational strategic and operational goals); and
- ◆ Contracting and purchasing constraints.

4.6.1.6 ORGANIZATIONAL PROCESS ASSETS

The organizational process assets that can influence the Perform Integrated Change Control process include but are not limited to:

- ◆ Change control procedures, including the steps by which organizational standards, policies, plans, procedures, or any project documents will be modified, and how any changes will be approved and validated;
- ◆ Procedures for approving and issuing change authorizations; and
- ◆ Configuration management knowledge base containing the versions and baselines of all official organizational standards, policies, procedures, and any project documents.

4.6.2 PERFORM INTEGRATED CHANGE CONTROL: TOOLS AND TECHNIQUES

4.6.2.1 EXPERT JUDGMENT

Described in Section 4.1.2.1. Expertise should be considered from individuals or groups with specialized knowledge of or training in the following topics:

- ◆ Technical knowledge of the industry and focus area of the project,
- ◆ Legislation and regulations,
- ◆ Legal and procurement,
- ◆ Configuration management, and
- ◆ Risk management.

4.6.2.2 CHANGE CONTROL TOOLS

In order to facilitate configuration and change management, manual or automated tools may be used. Configuration control is focused on the specification of both the deliverables and the processes, while change control is focused on identifying, documenting, and approving or rejecting changes to the project documents, deliverables, or baselines.

Tool selection should be based on the needs of the project stakeholders including organizational and environmental considerations and/or constraints. Tools should support the following configuration management activities:

- ◆ **Identify configuration item.** Identification and selection of a configuration item to provide the basis for which the product configuration is defined and verified, products and documents are labeled, changes are managed, and accountability is maintained.
- ◆ **Record and report configuration item status.** Information recording and reporting about each configuration item.
- ◆ **Perform configuration item verification and audit.** Configuration verification and configuration audits ensure that the composition of a project's configuration items is correct and that corresponding changes are registered, assessed, approved, tracked, and correctly implemented. This ensures that the functional requirements defined in the configuration documentation are met.

Tools should support the following change management activities as well:

- ◆ **Identify changes.** Identifying and selecting a change item for processes or project documents.
- ◆ **Document changes.** Documenting the change into a proper change request.
- ◆ **Decide on changes.** Reviewing the changes; approving, rejecting, deferring, or making any other decision about changes to the project documents, deliverables, or baselines.
- ◆ **Track changes.** Verifying that the changes are registered, assessed, approved, and tracked and communicating final results to stakeholders.

Tools are also used to manage the change requests and the resulting decisions. Additional considerations should be made for communications to assist the change control board (CCB) members in their duties, as well as to distribute the decisions to the appropriate stakeholders.

4.6.2.3 DATA ANALYSIS

Data analysis techniques that can be used for this process include but are not limited to:

- ◆ **Alternatives analysis.** Described in Section 9.2.2.5. This technique is used to assess the requested changes and decide which are accepted, rejected, or need to be modified to be finally accepted.
- ◆ **Cost-benefit analysis.** Described in Section 8.1.2.3. This analysis helps to determine if the requested change is worth its associated cost.

4.6.2.4 DECISION MAKING

Decision-making techniques that can be used for this process include but are not limited to:

- ◆ **Voting.** Described in Section 5.2.2.4. Voting can take the form of unanimity, majority, or plurality to decide on whether to accept, defer, or reject change requests.
- ◆ **Autocratic decision making.** In this decision-making technique, one individual takes the responsibility for making the decision for the entire group.
- ◆ **Multicriteria decision analysis.** Described in Section 8.1.2.4. This technique uses a decision matrix to provide a systematic analytical approach to evaluate the requested changes according to a set of predefined criteria.

4.6.2.5 MEETINGS

Change control meetings are held with a change control board (CCB) that is responsible for meeting and reviewing the change requests and approving, rejecting, or deferring change requests. Most changes will have some sort of impact on time, cost, resources, or risks. Assessing the impact of the changes is an essential part of the meeting. Alternatives to the requested changes may also be discussed and proposed. Finally, the decision is communicated to the request owner or group.

The CCB may also review configuration management activities. The roles and responsibilities of these boards are clearly defined and agreed upon by the appropriate stakeholders and are documented in the change management plan. CCB decisions are documented and communicated to the stakeholders for information and follow-up actions.

4.6.3 PERFORM INTEGRATED CHANGE CONTROL: OUTPUTS

4.6.3.1 APPROVED CHANGE REQUESTS

Change requests (described in Section 4.3.3.4) are processed according to the change management plan by the project manager, CCB, or an assigned team member. As a result, changes may be approved, deferred, or rejected. Approved change requests will be implemented through the Direct and Manage Project Work process. Deferred or rejected change requests are communicated to the person or group requesting the change.

The disposition of all change requests are recorded in the change log as a project document update.

4.6.3.2 PROJECT MANAGEMENT PLAN UPDATES

Any formally controlled component of the project management plan may be changed as a result of this process. Changes to baselines are only made from the last baseline forward. Past performance is not changed. This protects the integrity of the baselines and the historical data of past performance.

4.6.3.3 PROJECT DOCUMENTS UPDATES

Any formally controlled project document may be changed as a result of this process. A project document that is normally updated as a result of this process is the change log. The change log is used to document changes that occur during a project.

4.7 CLOSE PROJECT OR PHASE

Close Project or Phase is the process of finalizing all activities for the project, phase, or contract. The key benefits of this process are the project or phase information is archived, the planned work is completed, and organizational team resources are released to pursue new endeavors. This process is performed once or at predefined points in the project. The inputs, tools and techniques, and outputs of the process are depicted in Figure 4-14. Figure 4-15 depicts the data flow diagram for the process.

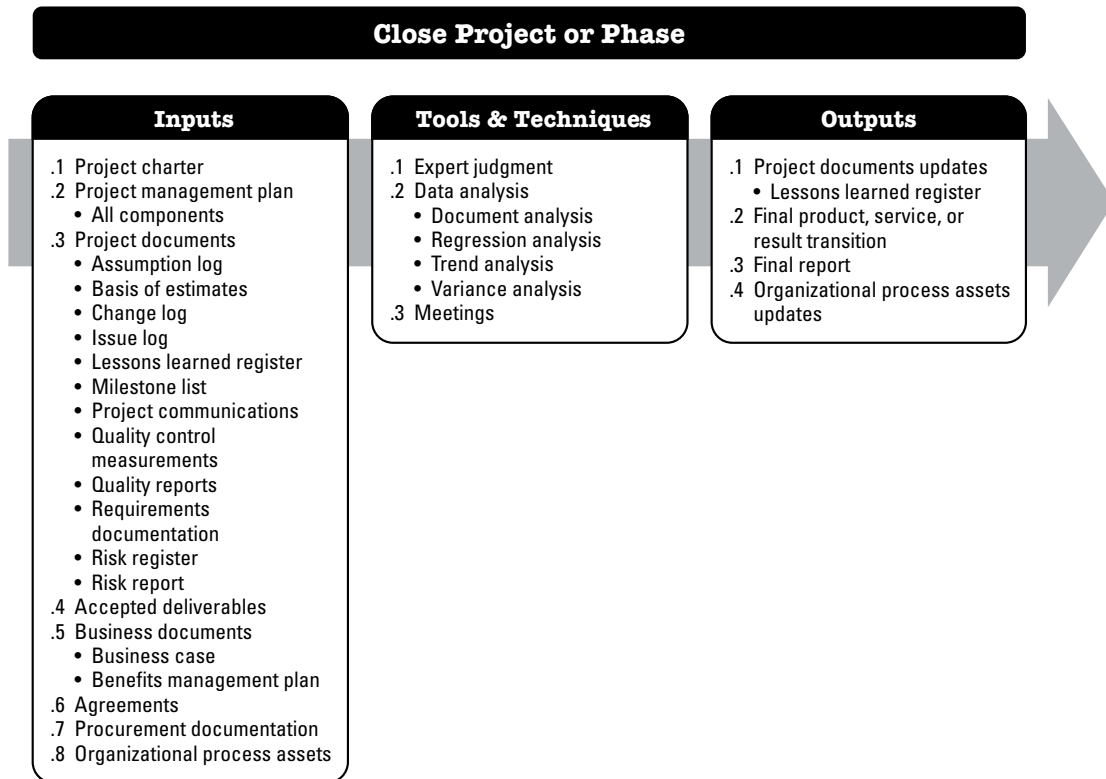

Figure 4-14. Close Project or Phase: Inputs, Tools & Techniques, and Outputs

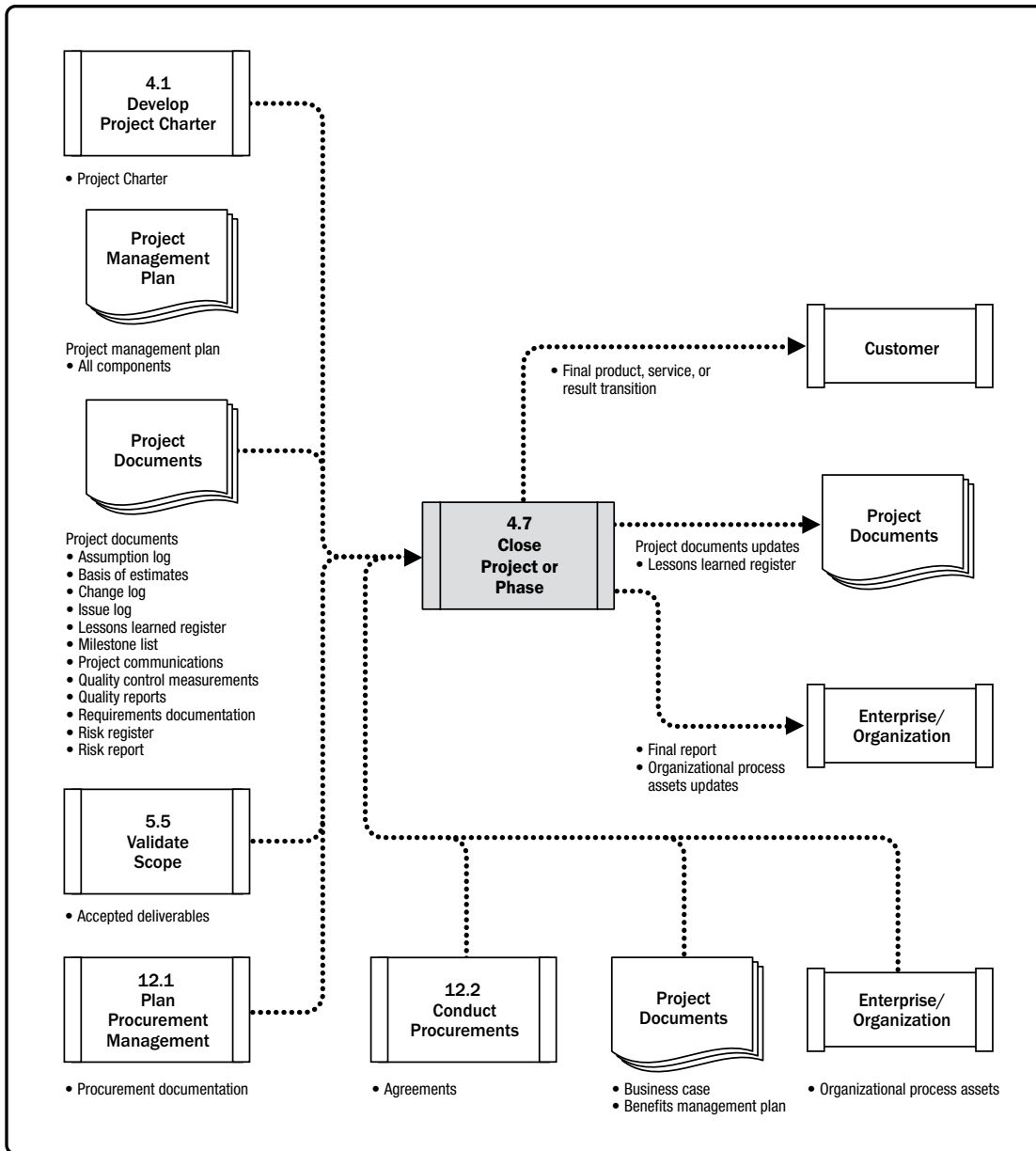

Figure 4-15. Close Project or Phase: Data Flow Diagram

When closing the project, the project manager reviews the project management plan to ensure that all project work is completed and that the project has met its objectives. The activities necessary for the administrative closure of the project or phase include but are not limited to:

- ◆ Actions and activities necessary to satisfy completion or exit criteria for the phase or project such as:
 - Making certain that all documents and deliverables are up-to-date and that all issues are resolved;
 - Confirming the delivery and formal acceptance of deliverables by the customer;
 - Ensuring that all costs are charged to the project;
 - Closing project accounts;
 - Reassigning personnel;
 - Dealing with excess project material;
 - Reallocating project facilities, equipment, and other resources; and
 - Elaborating the final project reports as required by organizational policies.
- ◆ Activities related to the completion of the contractual agreements applicable to the project or project phase such as:
 - Confirming the formal acceptance of the seller's work,
 - Finalizing open claims,
 - Updating records to reflect final results, and
 - Archiving such information for future use.
- ◆ Activities needed to:
 - Collect project or phase records,
 - Audit project success or failure,
 - Manage knowledge sharing and transfer,
 - Identify lessons learned, and
 - Archive project information for future use by the organization.
- ◆ Actions and activities necessary to transfer the project's products, services, or results to the next phase or to production and/or operations.
- ◆ Collecting any suggestions for improving or updating the policies and procedures of the organization, and sending them to the appropriate organizational unit.
- ◆ Measuring stakeholder satisfaction.

The Close Project or Phase process also establishes the procedures to investigate and document the reasons for actions taken if a project is terminated before completion. In order to successfully achieve this, the project manager needs to engage all the proper stakeholders in the process.

4.7.1 CLOSE PROJECT OR PHASE: INPUTS

4.7.1.1 PROJECT CHARTER

Described in Section 4.1.3.1. The project charter documents the project success criteria, the approval requirements, and who will sign off on the project.

4.7.1.2 PROJECT MANAGEMENT PLAN

Described in Section 4.2.3.1. All components of the project management plan are an input to this process.

4.7.1.3 PROJECT DOCUMENTS

Project documents that may be inputs for this process include but are not limited to:

- ◆ **Assumption log.** Described in Section 4.1.3.2. The assumption log has a record of all the assumptions and constraints that guided the technical specifications, estimates, schedule, risks, etc.
- ◆ **Basis of estimates.** Described in Sections 6.4.3.2 and 7.2.3.2. The basis of estimates is used to evaluate how the estimation of durations, cost, resources, and cost control compared to the actual results.
- ◆ **Change log.** Described in Section 4.6.3.3. The change log contains the status of all change requests throughout the project or phase.
- ◆ **Issue log.** Described in Section 4.3.3.3. The issue log is used to check that there is no open issue.
- ◆ **Lessons learned register.** Described in Section 4.3.3.1. The lessons learned in the phase or project will be finalized before being entered into the lessons learned repository.
- ◆ **Milestone list.** Described in Section 6.2.3.3. The milestone list shows the final dates on which the project milestones have been accomplished.
- ◆ **Project communications.** Described in Section 10.2.3.1. Project communications include any and all communications that have been created throughout the project.
- ◆ **Quality control measurements.** Described in Section 8.3.3.1. The quality control measurements document the results of Control Quality activities and demonstrate compliance with the quality requirements.
- ◆ **Quality reports.** Described in Section 8.2.3.1. The information presented in the quality report may include all quality assurance issues managed or escalated by the team, recommendations for improvement, and the summary of findings from the Control Quality process.
- ◆ **Requirements documentation.** Described in Section 5.2.3.1. Requirements documentation is used to demonstrate compliance with the project scope.

- ◆ **Risk register.** Described in Section 11.2.3.1. The risk register provides information on risks that have occurred throughout the project.
- ◆ **Risk report.** Described in Section 11.2.3.2. The risk report provides information on the risk status and is used to check that there are no open risks at the end of the project.

4.7.1.4 ACCEPTED DELIVERABLES

Described in Section 5.5.3.1. Accepted deliverables may include approved product specifications, delivery receipts, and work performance documents. Partial or interim deliverables may also be included for phased or cancelled projects.

4.7.1.5 BUSINESS DOCUMENTS

Described in Section 1.2.6. Business documents include but are not limited to:

- ◆ **Business case.** The business case documents the business need and the cost benefit analysis that justify the project.
- ◆ **Benefits management plan.** The benefits management plan outlines the target benefits of the project.

The business case is used to determine if the expected outcomes from the economic feasibility study used to justify the project occurred. The benefits management plan is used to measure whether the benefits of the project were achieved as planned.

4.7.1.6 AGREEMENTS

Described in Section 12.2.3.2. The requirements for formal procurement closure are usually defined in the terms and conditions of the contract and are included in the procurement management plan. A complex project may involve managing multiple contracts simultaneously or in sequence.

4.7.1.7 PROCUREMENT DOCUMENTATION

Described in Section 12.3.1.4. To close the contract, all procurement documentation is collected, indexed, and filed. Information on contract schedule, scope, quality, and cost performance along with all contract change documentation, payment records, and inspection results are cataloged. “As-built” plans/drawing or “as-developed” documents, manuals, troubleshooting, and other technical documentation should also be considered as part of the procurement documents when closing a project. This information can be used for lessons learned information and as a basis for evaluating contractors for future contracts.

4.7.1.8 ORGANIZATIONAL PROCESS ASSETS

The organizational process assets that can influence the Close Project or Phase process include but are not limited to:

- ◆ Project or phase closure guidelines or requirements (e.g., lessons learned, final project audits, project evaluations, product validations, acceptance criteria, contract closure, resource reassignment, team performance appraisals, and knowledge transfer).
- ◆ Configuration management knowledge base containing the versions and baselines of all official organizational standards, policies, procedures, and any project documents.

4.7.2 CLOSE PROJECT OR PHASE: TOOLS AND TECHNIQUES

4.7.2.1 EXPERT JUDGMENT

Described in Section 4.1.2.1. Expertise should be considered from individuals or groups with specialized knowledge or training in the following topics:

- ◆ Management control,
- ◆ Audit,
- ◆ Legal and procurement, and
- ◆ Legislation and regulations.

4.7.2.2 DATA ANALYSIS

Data analysis techniques that can be used in project closeout include but are not limited to:

- ◆ **Document analysis.** Described in Section 5.2.2.3. Assessing available documentation will allow identifying lessons learned and knowledge sharing for future projects and organizational assets improvement.
- ◆ **Regression analysis.** This technique analyzes the interrelationships between different project variables that contributed to the project outcomes to improve performance on future projects.
- ◆ **Trend analysis.** Described in Section 4.5.2.2. Trend analysis can be used to validate the models used in the organization and to implement adjustments for future projects.
- ◆ **Variance analysis.** Described in Section 4.5.2.2. Variance analysis can be used to improve the metrics of the organization by comparing what was initially planned and the end result.

4.7.2.3 MEETINGS

Meetings are used to confirm that the deliverables have been accepted, to validate that the exit criteria have been met, to formalize the completion of the contracts, to evaluate the satisfaction of the stakeholders, to gather lessons learned, to transfer knowledge and information from the project, and to celebrate success. Attendees may include project team members and other stakeholders involved in or affected by the project. Meetings may be face-to-face, virtual, formal, or informal. Types of meetings include but are not limited to close-out reporting meetings, customer wrap-up meetings, lessons learned meetings, and celebration meetings.

4.7.3 CLOSE PROJECT OR PHASE: OUTPUTS

4.7.3.1 PROJECT DOCUMENTS UPDATES

All project documents may be updated and marked as final versions as a result of project closure. Of particular interest is the lessons learned register, which is finalized to include final information on phase or project closure. The final lessons learned register may include information on benefits management, accuracy of the business case, project and development life cycles, risk and issue management, stakeholder engagement, and other project management processes.

4.7.3.2 FINAL PRODUCT, SERVICE, OR RESULT TRANSITION

A product, service, or result, once delivered by the project, may be handed over to a different group or organization that will operate, maintain, and support it throughout its life cycle.

This output refers to this transition of the final product, service, or result that the project was authorized to produce (or in the case of phase closure, the intermediate product, service, or result of that phase) from one team to another.

4.7.3.3 FINAL REPORT

The final report provides a summary of the project performance. It can include information such as:

- ◆ Summary level description of the project or phase.
- ◆ Scope objectives, the criteria used to evaluate the scope, and evidence that the completion criteria were met.
- ◆ Quality objectives, the criteria used to evaluate the project and product quality, the verification and actual milestone delivery dates, and reasons for variances.
- ◆ Cost objectives, including the acceptable cost range, actual costs, and reasons for any variances.
- ◆ Summary of the validation information for the final product, service, or result.

- ◆ Schedule objectives including whether results achieved the benefits that the project was undertaken to address. If the benefits are not met at the close of the project, indicate the degree to which they were achieved and estimate for future benefits realization.
- ◆ Summary of how the final product, service, or result achieved the business needs identified in the business plan. If the business needs are not met at the close of the project, indicate the degree to which they were achieved and estimate for when the business needs will be met in the future.
- ◆ Summary of any risks or issues encountered on the project and how they were addressed.

4.7.3.4 ORGANIZATIONAL PROCESS ASSET UPDATES

Organizational process assets that are updated include but are not limited to:

- ◆ **Project documents.** Documentation resulting from the project's activities; for example, project management plan; scope, cost, schedule, and project calendars; and change management documentation.
- ◆ **Operational and support documents.** Documents required for an organization to maintain, operate, and support the product or service delivered by the project. These may be new documents or updates to existing documents.
- ◆ **Project or phase closure documents.** Project or phase closure documents, consisting of formal documentation that indicates completion of the project or phase and the transfer of the completed project or phase deliverables to others, such as an operations group or to the next phase. During project closure, the project manager reviews prior phase documentation, customer acceptance documentation from the Validate Scope process (Section 5.5), and the agreement (if applicable) to ensure that all project requirements are completed prior to finalizing the closure of the project. If the project was terminated prior to completion, the formal documentation indicates why the project was terminated and formalizes the procedures for the transfer of the finished and unfinished deliverables of the cancelled project to others.
- ◆ **Lessons learned repository.** Lessons learned and knowledge gained throughout the project are transferred to the lessons learned repository for use by future projects.

5

PROJECT SCOPE MANAGEMENT

Project Scope Management includes the processes required to ensure that the project includes all the work required, and only the work required, to complete the project successfully. Managing the project scope is primarily concerned with defining and controlling what is and is not included in the project.

The Project Scope Management processes are:

5.1 Plan Scope Management—The process of creating a scope management plan that documents how the project and product scope will be defined, validated, and controlled.

5.2 Collect Requirements—The process of determining, documenting, and managing stakeholder needs and requirements to meet project objectives.

5.3 Define Scope—The process of developing a detailed description of the project and product.

5.4 Create WBS—The process of subdividing project deliverables and project work into smaller, more manageable components.

5.5 Validate Scope—The process of formalizing acceptance of the completed project deliverables.

5.6 Control Scope—The process of monitoring the status of the project and product scope and managing changes to the scope baseline.

Figure 5-1 provides an overview of the Project Scope Management processes. The Project Scope Management processes are presented as discrete processes with defined interfaces while, in practice, they overlap and interact in ways that cannot be completely detailed in the *PMBOK® Guide*.

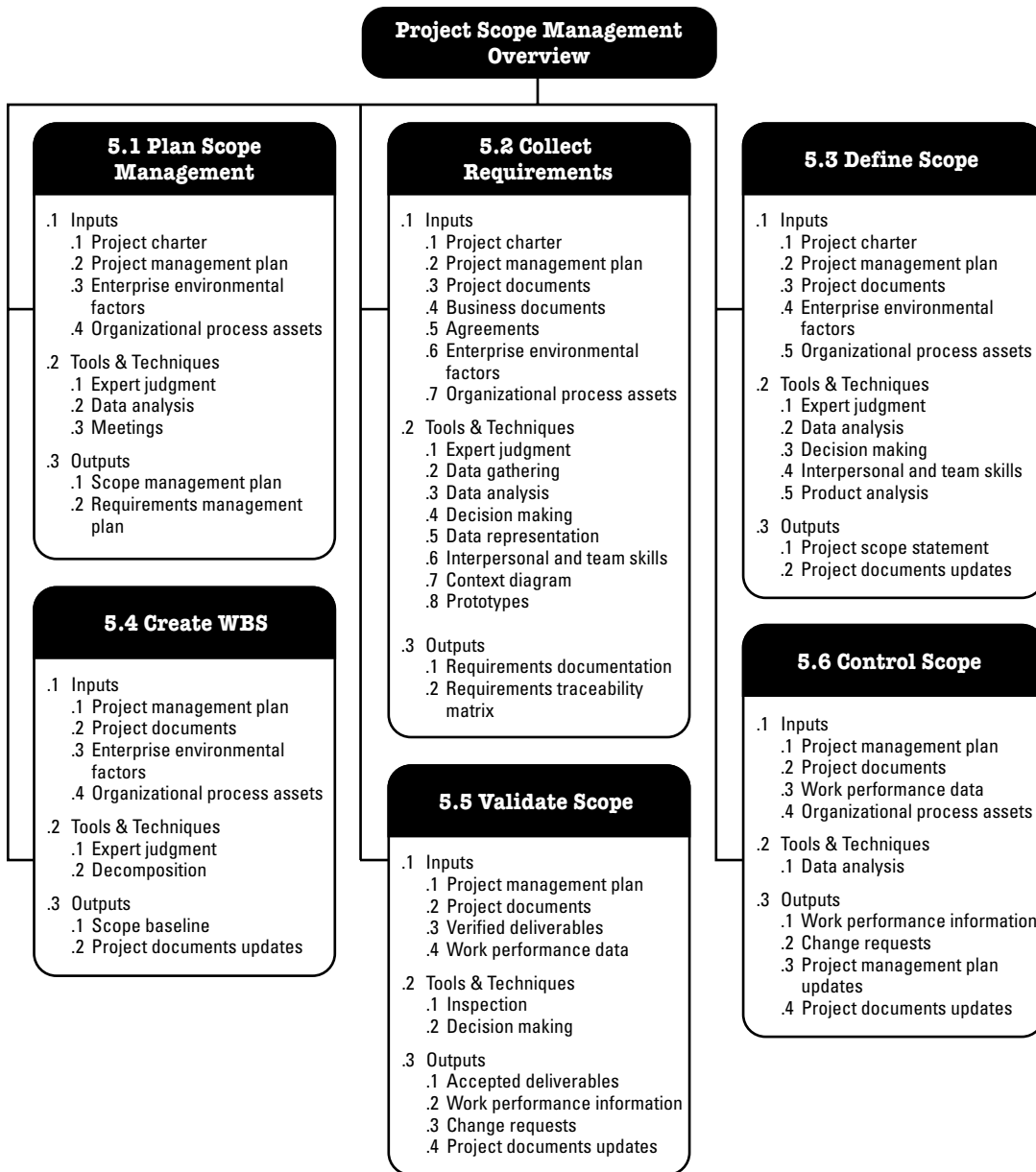

Figure 5-1. Project Scope Management Overview

KEY CONCEPTS FOR PROJECT SCOPE MANAGEMENT

In the project context, the term “scope” can refer to:

- ◆ **Product scope.** The features and functions that characterize a product, service, or result.
- ◆ **Project scope.** The work performed to deliver a product, service, or result with the specified features and functions. The term “project scope” is sometimes viewed as including product scope.

Project life cycles can range along a continuum from predictive approaches at one end to adaptive or agile approaches at the other. In a predictive life cycle, the project deliverables are defined at the beginning of the project and any changes to the scope are progressively managed. In an adaptive or agile life cycle, the deliverables are developed over multiple iterations where a detailed scope is defined and approved for each iteration when it begins.

Projects with adaptive life cycles are intended to respond to high levels of change and require ongoing stakeholder engagement. The overall scope of an adaptive project will be decomposed into a set of requirements and work to be performed, sometimes referred to as a product backlog. At the beginning of an iteration, the team will work to determine how many of the highest-priority items on the backlog list can be delivered within the next iteration. Three processes (Collect Requirements, Define Scope, and Create WBS) are repeated for each iteration. On the contrary, in a predictive project, these processes are performed toward the beginning of the project and updated as necessary, using the integrated change control process.

In an adaptive or agile life cycle, the sponsor and customer representatives should be continuously engaged with the project to provide feedback on deliverables as they are created and to ensure that the product backlog reflects their current needs. Two processes (Validate Scope and Control Scope) are repeated for each iteration. On the contrary, in a predictive project, Validate Scope occurs with each deliverable or phase review and Control Scope is an ongoing process.

In predictive projects, the scope baseline for the project is the approved version of the project scope statement, work breakdown structure (WBS), and its associated WBS dictionary. A baseline can be changed only through formal change control procedures and is used as a basis for comparison while performing Validate Scope and Control Scope processes as well as other controlling processes. Projects with adaptive life cycles use backlogs (including product requirements and user stories) to reflect their current needs.

Completion of the project scope is measured against the project management plan, while completion of the product scope is measured against the product requirements. The term “requirement” is defined as a condition or capability that is required to be present in a product, service, or result to satisfy an agreement or other formally imposed specification.

Validate Scope is the process of formalizing acceptance of the completed project deliverables. The verified deliverables obtained from the Control Quality process are an input to the Validate Scope process. One of the outputs of Validate Scope is accepted deliverables that are formally signed off and approved by the authorized stakeholder. Therefore, the stakeholder needs to get involved early on during planning (sometimes initiating as well) and to provide inputs about quality of deliverables so that Control Quality can assess the performance and recommend necessary changes.

TRENDS AND EMERGING PRACTICES IN PROJECT SCOPE MANAGEMENT

Requirements have always been a concern in project management and have continued to gain more attention in the profession. As the global environment becomes more complex, organizations are starting to recognize how to use business analysis to their competitive advantage by defining, managing, and controlling requirements activities. Activities of business analysis may start before a project is initiated and a project manager is assigned. According to *Requirements Management: A Practice Guide* [14], the requirements management process starts with a needs assessment, which may begin in portfolio planning, in program planning, or within a discrete project.

Eliciting, documenting, and managing stakeholder requirements takes place within the Project Scope Management processes. Trends and emerging practices for Project Scope Management include but are not limited to a focus on collaborating with business analysis professionals to:

- ◆ Determine problems and identify business needs;
- ◆ Identify and recommend viable solutions for meeting those needs;
- ◆ Elicit, document, and manage stakeholder requirements in order to meet business and project objectives; and
- ◆ Facilitate the successful implementation of the product, service, or end result of the program or project [7].

The process ends with the requirements closure, which transitions the product, service, or result to the recipient in order to measure, monitor, realize, and sustain benefits over time.

The role with responsibility to conduct business analysis should be assigned to resources with sufficient business analysis skills and expertise. If a business analyst is assigned to a project, requirement-related activities are the responsibility of that role. The project manager is responsible for ensuring that requirements-related work is accounted for in the project management plan and that requirements-related activities are performed on time and within budget and deliver value.

The relationship between a project manager and a business analyst should be a collaborative partnership. A project will have a higher likelihood of being successful if project managers and business analysts fully understand each other's roles and responsibilities to successfully achieve project objectives.



TAILORING CONSIDERATIONS

Because each project is unique, the project manager will need to tailor the way Project Scope Management processes are applied. Considerations for tailoring include but are not limited to:

- ◆ **Knowledge and requirements management.** Does the organization have formal or informal knowledge and requirements management systems? What guidelines should the project manager establish for requirements to be reused in the future?
- ◆ **Validation and control.** Does the organization have existing formal or informal validation and control-related policies, procedures, and guidelines?
- ◆ **Development approach.** Does the organization use agile approaches in managing projects? Is the development approach iterative or incremental? Is a predictive approach used? Will a hybrid approach be productive?
- ◆ **Stability of requirements.** Are there areas of the project with unstable requirements? Do unstable requirements necessitate the use of lean, agile, or other adaptive techniques until they are stable and well defined?
- ◆ **Governance.** Does the organization have formal or informal audit and governance policies, procedures, and guidelines?

CONSIDERATIONS FOR AGILE/ADAPTIVE ENVIRONMENTS

In projects with evolving requirements, high risk, or significant uncertainty, the scope is often not understood at the beginning of the project or it evolves during the project. Agile methods deliberately spend less time trying to define and agree on scope in the early stage of the project and spend more time establishing the process for its ongoing discovery and refinement. Many environments with emerging requirements find that there is often a gap between the real business requirements and the business requirements that were originally stated. Therefore, agile methods purposefully build and review prototypes and release versions in order to refine the requirements. As a result, scope is defined and redefined throughout the project. In agile approaches, the requirements constitute the backlog.

5.1 PLAN SCOPE MANAGEMENT

Plan Scope Management is the process of creating a scope management plan that documents how the project and product scope will be defined, validated, and controlled. The key benefit of this process is that it provides guidance and direction on how scope will be managed throughout the project. This process is performed once or at predefined points in the project. The inputs, tools and techniques, and outputs of this process are depicted in Figure 5-2. Figure 5-3 depicts the data flow diagram of the process.

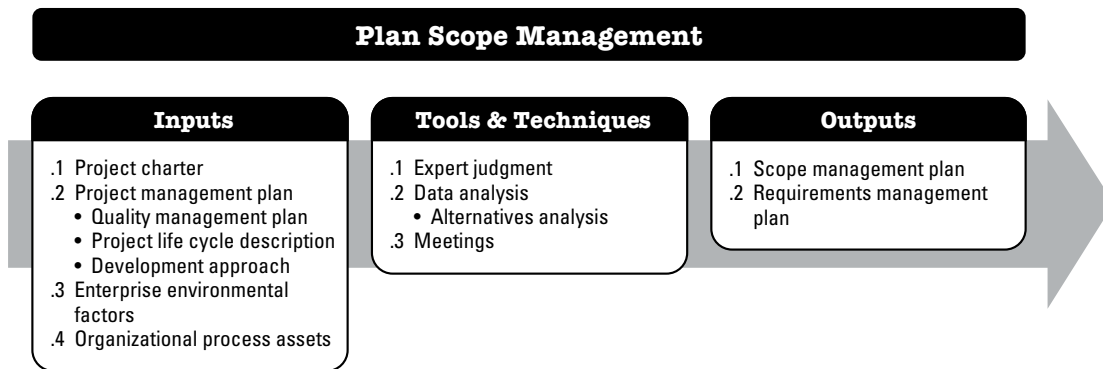

Figure 5-2. Plan Scope Management: Inputs, Tools & Techniques, and Outputs

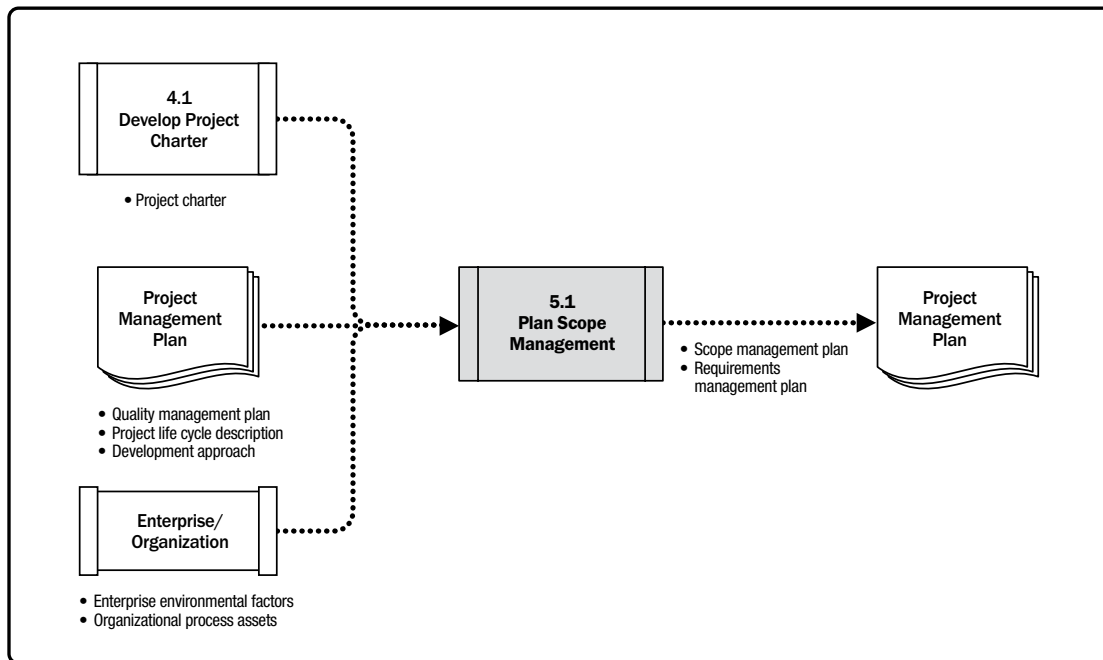

Figure 5-3. Plan Scope Management: Data Flow Diagram

The scope management plan is a component of the project or program management plan that describes how the scope will be defined, developed, monitored, controlled, and validated. The development of the scope management plan and the detailing of the project scope begin with the analysis of information contained in the project charter (Section 4.1.3.1), the latest approved subsidiary plans of the project management plan (Section 4.2.3.1), historical information contained in the organizational process assets (Section 2.3), and any other relevant enterprise environmental factors (Section 2.2).

5.1.1 PLAN SCOPE MANAGEMENT: INPUTS

5.1.1.1 PROJECT CHARTER

Described in Section 4.1.3.1. The project charter documents the project purpose, high-level project description, assumptions, constraints, and high-level requirements that the project is intended to satisfy.

5.1.1.2 PROJECT MANAGEMENT PLAN

Described in Section 4.2.3.1. Project management plan components include but are not limited to:

- ◆ **Quality management plan.** Described in Section 8.1.3.1. The way the project and product scope will be managed can be influenced by how the organization's quality policy, methodologies, and standards are implemented on the project.
- ◆ **Project life cycle description.** The project life cycle determines the series of phases that a project passes through from its inception to the end of the project.
- ◆ **Development approach.** The development approach defines whether waterfall, iterative, adaptive, agile, or a hybrid development approach will be used.

5.1.1.3 ENTERPRISE ENVIRONMENTAL FACTORS

The enterprise environmental factors that can influence the Plan Scope Management process include but are not limited to:

- ◆ Organization's culture,
- ◆ Infrastructure,
- ◆ Personnel administration, and
- ◆ Marketplace conditions.

5.1.1.4 ORGANIZATIONAL PROCESS ASSETS

The organizational process assets that can influence the Plan Scope Management process include but are not limited to:

- ◆ Policies and procedures, and
- ◆ Historical information and lessons learned repositories.

5.1.2 PLAN SCOPE MANAGEMENT: TOOLS AND TECHNIQUES

5.1.2.1 EXPERT JUDGMENT

Described in Section 4.1.2.1 Expertise should be considered from individuals or groups with specialized knowledge or training in the following topics:

- ◆ Previous similar projects, and
- ◆ Information in the industry, discipline, and application area.

5.1.2.2 DATA ANALYSIS

A data analysis technique that can be used for this process includes but is not limited to alternatives analysis. Various ways of collecting requirements, elaborating the project and product scope, creating the product, validating the scope, and controlling the scope are evaluated.

5.1.2.3 MEETINGS

Project teams may attend project meetings to develop the scope management plan. Attendees may include the project manager, the project sponsor, selected project team members, selected stakeholders, anyone with responsibility for any of the scope management processes, and others as needed.

5.1.3 PLAN SCOPE MANAGEMENT: OUTPUTS

5.1.3.1 SCOPE MANAGEMENT PLAN

The scope management plan is a component of the project management plan that describes how the scope will be defined, developed, monitored, controlled, and validated. The components of a scope management plan include:

- ◆ Process for preparing a project scope statement;
- ◆ Process that enables the creation of the WBS from the detailed project scope statement;
- ◆ Process that establishes how the scope baseline will be approved and maintained; and
- ◆ Process that specifies how formal acceptance of the completed project deliverables will be obtained.

The scope management plan can be formal or informal, broadly framed or highly detailed, based on the needs of the project.

5.1.3.2 REQUIREMENTS MANAGEMENT PLAN

The requirements management plan is a component of the project management plan that describes how project and product requirements will be analyzed, documented, and managed. According to *Business Analysis for Practitioners: A Practice Guide* [7], some organizations refer to it as a business analysis plan. Components of the requirements management plan can include but are not limited to:

- ◆ How requirements activities will be planned, tracked, and reported;
- ◆ Configuration management activities such as: how changes will be initiated; how impacts will be analyzed; how they will be traced, tracked, and reported; as well as the authorization levels required to approve these changes;
- ◆ Requirements prioritization process;
- ◆ Metrics that will be used and the rationale for using them; and
- ◆ Traceability structure that reflects the requirement attributes captured on the traceability matrix.



5.2 COLLECT REQUIREMENTS

Collect Requirements is the process of determining, documenting, and managing stakeholder needs and requirements to meet objectives. The key benefit of this process is that it provides the basis for defining the product scope and project scope. This process is performed once or at predefined points in the project. The inputs, tools and techniques, and outputs of this process are depicted in Figure 5-4. Figure 5-5 depicts the data flow diagram of the process.

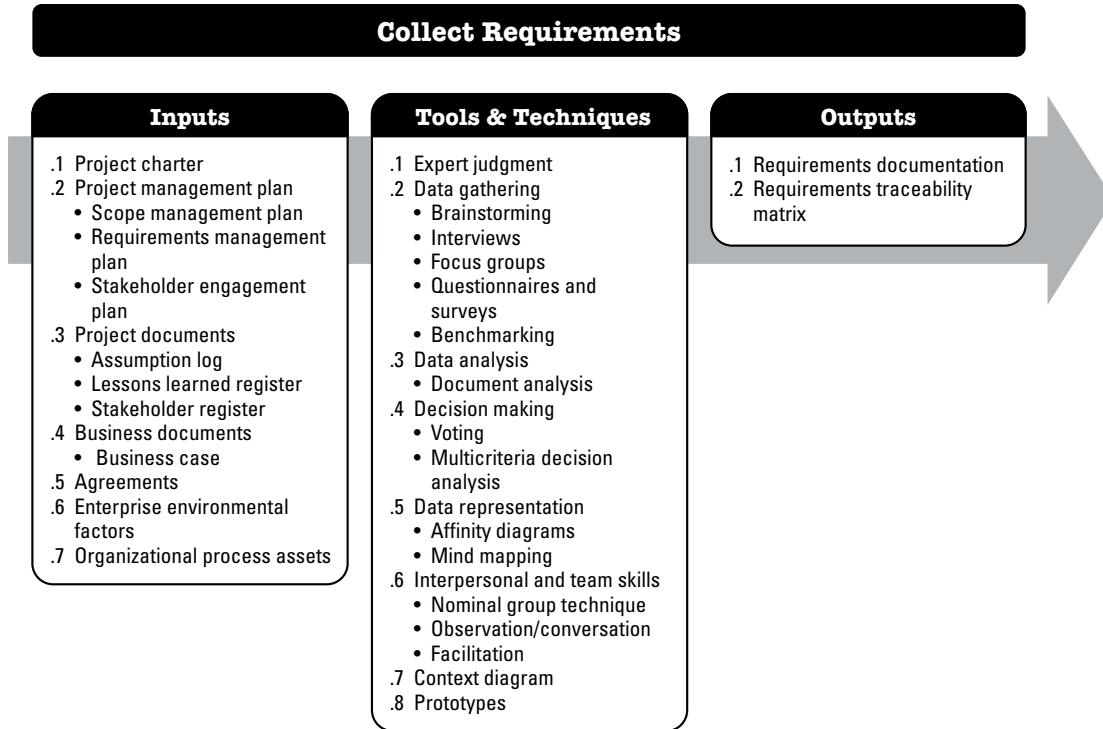

Figure 5-4. Collect Requirements: Inputs, Tools & Techniques, and Outputs

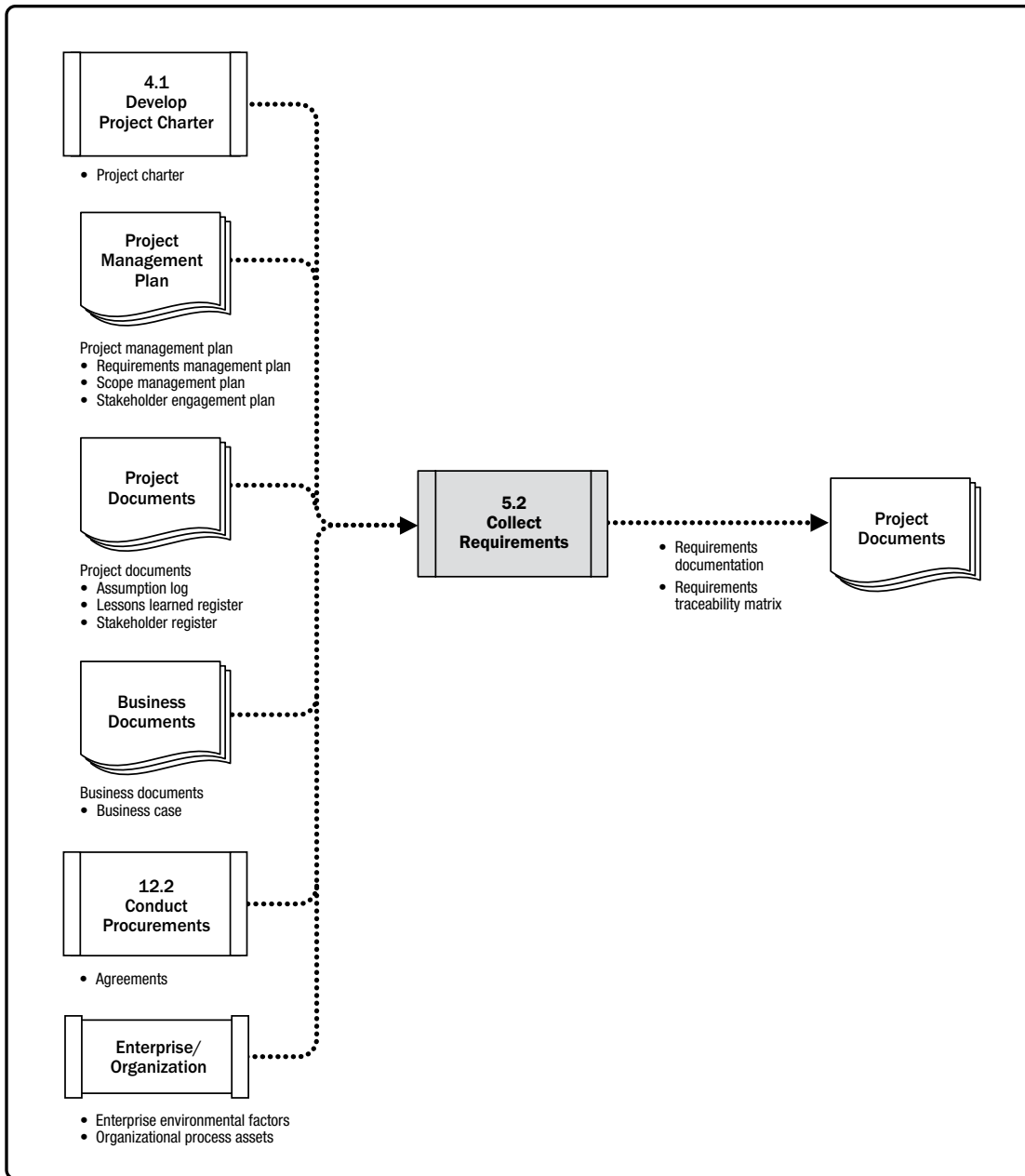

Figure 5-5. Collect Requirements: Data Flow Diagram

The *PMBOK® Guide* does not specifically address product requirements since those are industry specific. Note that *Business Analysis for Practitioners: A Practice Guide* [7] provides more in-depth information about product requirements. The project's success is directly influenced by active stakeholder involvement in the discovery and decomposition of needs into project and product requirements and by the care taken in determining, documenting, and managing the requirements of the product, service, or result of the project. Requirements include conditions or capabilities that are required to be present in a product, service, or result to satisfy an agreement or other formally imposed specification. Requirements include the quantified and documented needs and expectations of the sponsor, customer, and other stakeholders. These requirements need to be elicited, analyzed, and recorded in enough detail to be included in the scope baseline and to be measured once project execution begins. Requirements become the foundation of the WBS. Cost, schedule, quality planning, and procurement are all based on these requirements.

5.2.1 COLLECT REQUIREMENTS: INPUTS

5.2.1.1 PROJECT CHARTER

Described in Section 4.1.3.1. The project charter documents the high-level project description and high-level requirements that will be used to develop detailed requirements.

5.2.1.2 PROJECT MANAGEMENT PLAN

Described in Section 4.2.3.1. Project management plan components include but are not limited to:

- ◆ **Scope management plan.** Described in Section 5.1.3.1. The scope management plan contains information on how the project scope will be defined and developed.
- ◆ **Requirements management plan.** Described in Section 5.1.3.2. The requirements management plan has information on how project requirements will be collected, analyzed, and documented.
- ◆ **Stakeholder engagement plan.** Described in Section 13.2.3.1. The stakeholder engagement plan is used to understand stakeholder communication requirements and the level of stakeholder engagement in order to assess and adapt to the level of stakeholder participation in requirements activities.

5.2.1.3 PROJECT DOCUMENTS

Examples of project documents that can be considered as inputs for this process include but are not limited to:

- ◆ **Assumption Log.** Described in Section 4.1.3.2. The assumption log identified assumptions about the product, project, environment, stakeholders, and other factors that can influence requirements.
- ◆ **Lessons learned register.** Described in Section 4.4.3.1. The lessons learned register is used to provide information on effective requirements collection techniques, especially for projects that are using an iterative or adaptive product development methodology.
- ◆ **Stakeholder Register.** Described in Section 13.1.3.1. The stakeholder register is used to identify stakeholders who can provide information on the requirements. It also captures requirements and expectations that stakeholders have for the project.

5.2.1.4 BUSINESS DOCUMENTS

Described in Section 1.2.6. A business document that can influence the Collect Requirements process is the business case, which can describe required, desired, and optional criteria for meeting the business needs.

5.2.1.5 AGREEMENTS

Described in Section 12.2.3.2. Agreements can contain project and product requirements.

5.2.1.6 ENTERPRISE ENVIRONMENTAL FACTORS

The enterprise environmental factors that can influence the Collect Requirements process include but are not limited to:

- ◆ Organization's culture,
- ◆ Infrastructure,
- ◆ Personnel administration, and
- ◆ Marketplace conditions.

5.2.1.7 ORGANIZATIONAL PROCESS ASSETS

The organizational process assets that can influence the Collect Requirements process include but are not limited to:

- ◆ Policies and procedures, and
- ◆ Historical information and lessons learned repository with information from previous projects.

5.2.2 COLLECT REQUIREMENTS: TOOLS AND TECHNIQUES

5.2.2.1 EXPERT JUDGMENT

Described in Section 4.1.2.1. Expertise should be considered from individuals or groups with specialized knowledge or training in the following topics:

- ◆ Business analysis,
- ◆ Requirements elicitation,
- ◆ Requirements analysis,
- ◆ Requirements documentation,
- ◆ Project requirements in previous similar projects,
- ◆ Diagramming techniques,
- ◆ Facilitation, and
- ◆ Conflict management.

5.2.2.2 DATA GATHERING

Data-gathering techniques that can be used for this process include but are not limited to:

- ◆ **Brainstorming.** Described in Section 4.1.2.2. Brainstorming is a technique used to generate and collect multiple ideas related to project and product requirements.
- ◆ **Interviews.** An interview is a formal or informal approach to elicit information from stakeholders by talking to them directly. It is typically performed by asking prepared and spontaneous questions and recording the responses. Interviews are often conducted on an individual basis between an interviewer and an interviewee, but may involve multiple interviewers and/or multiple interviewees. Interviewing experienced project participants, sponsors, other executives, and subject matter experts can aid in identifying and defining the features and functions of the desired product deliverables. Interviews are also useful for obtaining confidential information.
- ◆ **Focus groups.** Focus groups bring together prequalified stakeholders and subject matter experts to learn about their expectations and attitudes about a proposed product, service, or result. A trained moderator guides the group through an interactive discussion designed to be more conversational than a one-on-one interview.

- ◆ **Questionnaires and surveys.** Questionnaires and surveys are written sets of questions designed to quickly accumulate information from a large number of respondents. Questionnaires and/or surveys are most appropriate with varied audiences, when a quick turnaround is needed, when respondents are geographically dispersed, and where statistical analysis could be appropriate.
- ◆ **Benchmarking.** Described in Section 8.1.2.2. Benchmarking involves comparing actual or planned products, processes, and practices to those of comparable organizations to identify best practices, generate ideas for improvement, and provide a basis for measuring performance. The organizations compared during benchmarking can be internal or external.

5.2.2.3 DATA ANALYSIS

Described in Section 4.5.2.2. Data analysis techniques that can be used for this process include but are not limited to document analysis. Document analysis consists of reviewing and assessing any relevant documented information. In this process, document analysis is used to elicit requirements by analyzing existing documentation and identifying information relevant to the requirements. There is a wide range of documents that may be analyzed to help elicit relevant requirements. Examples of documents that may be analyzed include but are not limited to:

- ◆ Agreements;
- ◆ Business plans;
- ◆ Business process or interface documentation;
- ◆ Business rules repositories;
- ◆ Current process flows;
- ◆ Marketing literature;
- ◆ Problem/issue logs;
- ◆ Policies and procedures;
- ◆ Regulatory documentation such as laws, codes, or ordinances, etc.;
- ◆ Requests for proposal; and
- ◆ Use cases.

5.2.2.4 DECISION MAKING

Decision-making techniques that can be used in the Collect Requirements process include but are not limited to:

- ◆ **Voting.** Voting is a collective decision-making technique and an assessment process having multiple alternatives with an expected outcome in the form of future actions. These techniques can be used to generate, classify, and prioritize product requirements. Examples of voting techniques include:
 - *Unanimity.* A decision that is reached whereby everyone agrees on a single course of action.
 - *Majority.* A decision that is reached with support obtained from more than 50% of the members of the group. Having a group size with an uneven number of participants can ensure that a decision will be reached, rather than resulting in a tie.
 - *Plurality.* A decision that is reached whereby the largest block in a group decides, even if a majority is not achieved. This method is generally used when the number of options nominated is more than two.
- ◆ **Autocratic decision making.** In this method, one individual takes responsibility for making the decision for the group.
- ◆ **Multicriteria decision analysis.** A technique that uses a decision matrix to provide a systematic analytical approach for establishing criteria, such as risk levels, uncertainty, and valuation, to evaluate and rank many ideas.

5.2.2.5 DATA REPRESENTATION

Data representation techniques that can be used for this process include but are not limited to:

- ◆ **Affinity diagrams.** Affinity diagrams allow large numbers of ideas to be classified into groups for review and analysis.
- ◆ **Mind mapping.** Mind mapping consolidates ideas created through individual brainstorming sessions into a single map to reflect commonality and differences in understanding and to generate new ideas.

5.2.2.6 INTERPERSONAL AND TEAM SKILLS

Described in Section 4.1.2.3. The interpersonal and team skills that can be used in this process include but are not limited to:

- ◆ **Nominal group technique.** The nominal group technique enhances brainstorming with a voting process used to rank the most useful ideas for further brainstorming or for prioritization. The nominal group technique is a structured form of brainstorming consisting of four steps:

- A question or problem is posed to the group. Each person silently generates and writes down their ideas.
 - The moderator writes down the ideas on a flip chart until all ideas are recorded.
 - Each recorded idea is discussed until all group members have a clear understanding.
 - Individuals vote privately to prioritize the ideas, usually using a scale of 1 – 5, with 1 being the lowest and 5 being the highest. Voting may take place in many rounds to reduce and focus in on ideas. After each round, the votes are tallied and the highest scoring ideas are selected.
- ◆ **Observation/conversation.** Observation and conversation provide a direct way of viewing individuals in their environment and how they perform their jobs or tasks and carry out processes. It is particularly helpful for detailed processes when the people who use the product have difficulty or are reluctant to articulate their requirements. Observation is also known as “job shadowing.” It is usually done externally by an observer viewing a business expert performing a job. It can also be done by a “participant observer” who actually performs a process or procedure to experience how it is done to uncover hidden requirements.
- ◆ **Facilitation.** Described in Section 4.1.2.3. Facilitation is used with focused sessions that bring key stakeholders together to define product requirements. Workshops can be used to quickly define cross-functional requirements and reconcile stakeholder differences. Because of their interactive group nature, well-facilitated sessions can build trust, foster relationships, and improve communication among the participants, which can lead to increased stakeholder consensus. In addition, issues can be discovered earlier and resolved more quickly than in individual sessions.

Facilitation skills are used in the following situations, but are not limited to:

- *Joint application design/development (JAD).* JAD sessions are used in the software development industry. These facilitated sessions focus on bringing business subject matter experts and the development team together to gather requirements and improve the software development process.
- *Quality function deployment (QFD).* In the manufacturing industry, QFD is another facilitation technique that helps determine critical characteristics for new product development. QFD starts by collecting customer needs, also known as voice of the customer (VOC). These needs are then objectively sorted and prioritized, and goals are set for achieving them.
- *User stories.* User stories, which are short, textual descriptions of required functionality, are often developed during a requirements workshop. User stories describe the stakeholder role, who benefits from the feature (role), what the stakeholder needs to accomplish (goal), and the benefit to the stakeholder (motivation).

5.2.2.7 CONTEXT DIAGRAM

The context diagram is an example of a scope model. Context diagrams visually depict the product scope by showing a business system (process, equipment, computer system, etc.), and how people and other systems (actors) interact with it (see Figure 5-6). Context diagrams show inputs to the business system, the actor(s) providing the input, the outputs from the business system, and the actor(s) receiving the output.

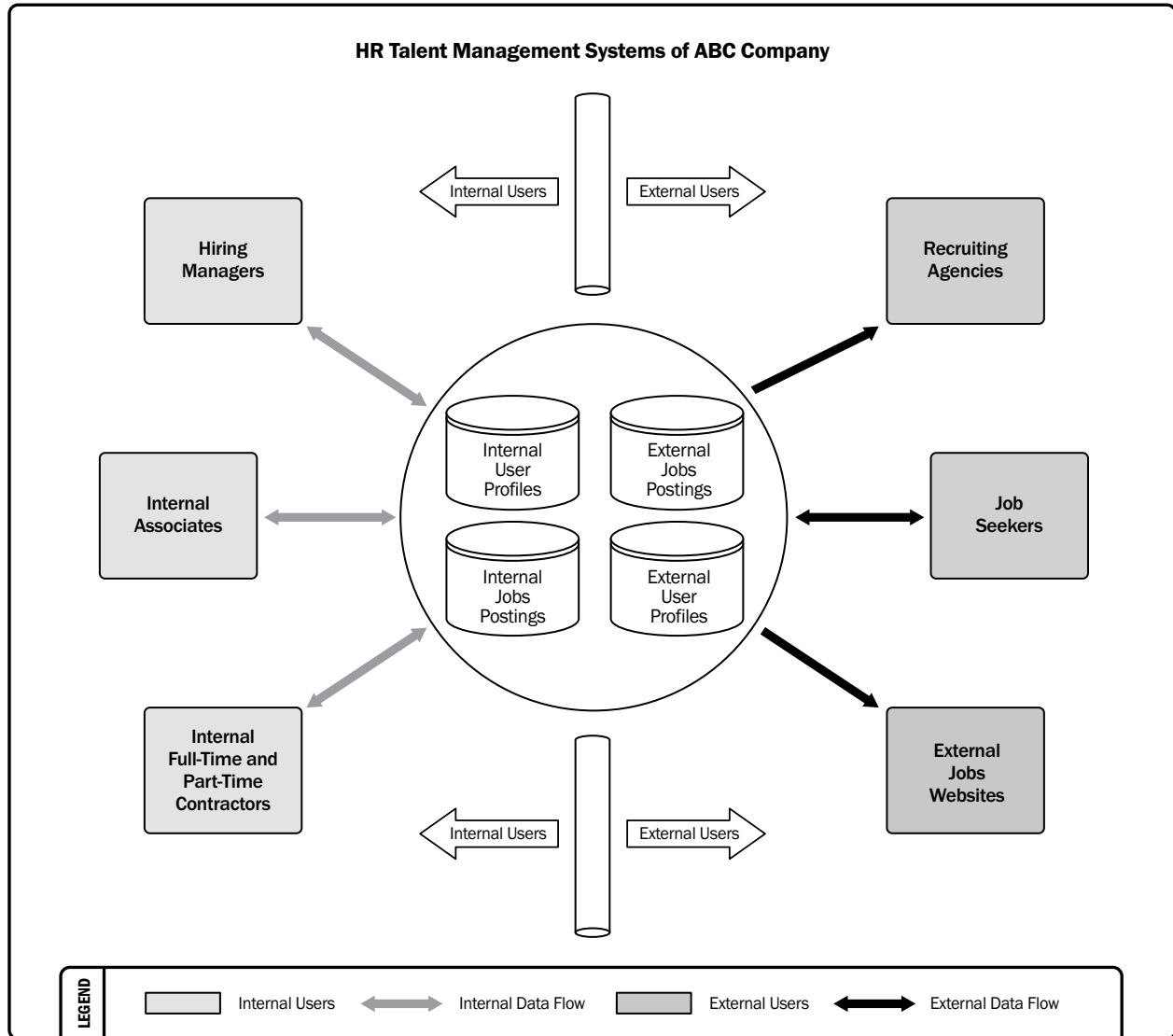

Figure 5-6. Context Diagram

5.2.2.8 PROTOTYPES

Prototyping is a method of obtaining early feedback on requirements by providing a model of the expected product before actually building it. Examples of prototypes are small-scale products, computer generated 2D and 3D models, mock-ups, or simulations. Prototypes allow stakeholders to experiment with a model of the final product rather than being limited to discussing abstract representations of their requirements. Prototypes support the concept of progressive elaboration in iterative cycles of mock-up creation, user experimentation, feedback generation, and prototype revision. When enough feedback cycles have been performed, the requirements obtained from the prototype are sufficiently complete to move to a design or build phase.

Storyboarding is a prototyping technique showing sequence or navigation through a series of images or illustrations. Storyboards are used on a variety of projects in a variety of industries, such as film, advertising, instructional design, and on agile and other software development projects. In software development, storyboards use mock-ups to show navigation paths through web pages, screens, or other user interfaces.

5.2.3 COLLECT REQUIREMENTS: OUTPUTS

5.2.3.1 REQUIREMENTS DOCUMENTATION

Requirements documentation describes how individual requirements meet the business need for the project. Requirements may start out at a high level and become progressively more detailed as more information about the requirements is known. Before being baselined, requirements need to be unambiguous (measurable and testable), traceable, complete, consistent, and acceptable to key stakeholders. The format of the requirements document may range from a simple document listing all the requirements categorized by stakeholder and priority, to more elaborate forms containing an executive summary, detailed descriptions, and attachments.



Many organizations categorize requirements into different types, such as business and technical solutions, the former referring to stakeholder needs and the latter as to how those needs will be implemented. Requirements can be grouped into classifications allowing for further refinement and detail as the requirements are elaborated. These classifications include:

- ◆ **Business requirements.** These describe the higher-level needs of the organization as a whole, such as the business issues or opportunities, and reasons why a project has been undertaken.
- ◆ **Stakeholder requirements.** These describe needs of a stakeholder or stakeholder group.
- ◆ **Solution requirements.** These describe features, functions, and characteristics of the product, service, or result that will meet the business and stakeholder requirements. Solution requirements are further grouped into functional and nonfunctional requirements:
 - *Functional requirements.* Functional requirements describe the behaviors of the product. Examples include actions, processes, data, and interactions that the product should execute.
 - *Nonfunctional requirements.* Nonfunctional requirements supplement functional requirements and describe the environmental conditions or qualities required for the product to be effective. Examples include: reliability, security, performance, safety, level of service, supportability, retention/purge, etc.
- ◆ **Transition and readiness requirements.** These describe temporary capabilities, such as data conversion and training requirements, needed to transition from the current as-is state to the desired future state.
- ◆ **Project requirements.** These describe the actions, processes, or other conditions the project needs to meet. Examples include milestone dates, contractual obligations, constraints, etc.
- ◆ **Quality requirements.** These capture any condition or criteria needed to validate the successful completion of a project deliverable or fulfillment of other project requirements. Examples include tests, certifications, validations, etc.

5.2.3.2 REQUIREMENTS TRACEABILITY MATRIX

The requirements traceability matrix is a grid that links product requirements from their origin to the deliverables that satisfy them. The implementation of a requirements traceability matrix helps ensure that each requirement adds business value by linking it to the business and project objectives. It provides a means to track requirements throughout the project life cycle, helping to ensure that requirements approved in the requirements documentation are delivered at the end of the project. Finally, it provides a structure for managing changes to the product scope.

Tracing requirements includes but is not limited to:

- ◆ Business needs, opportunities, goals, and objectives;
- ◆ Project objectives;
- ◆ Project scope and WBS deliverables;
- ◆ Product design;
- ◆ Product development;
- ◆ Test strategy and test scenarios; and
- ◆ High-level requirements to more detailed requirements.

Attributes associated with each requirement can be recorded in the requirements traceability matrix. These attributes help to define key information about the requirement. Typical attributes used in the requirements traceability matrix may include: a unique identifier, a textual description of the requirement, the rationale for inclusion, owner, source, priority, version, current status (such as active, cancelled, deferred, added, approved, assigned, completed), and status date. Additional attributes to ensure that the requirement has met stakeholders' satisfaction may include stability, complexity, and acceptance criteria. Figure 5-7 provides an example of a requirements traceability matrix with its associated attributes.

Requirements Traceability Matrix								
Project Name:								
Cost Center:								
Project Description:								
ID	Associate ID	Requirements Description	Business Needs, Opportunities, Goals, Objectives	Project Objectives	WBS Deliverables	Product Design	Product Development	Test Cases
001	1.0							
	1.1							
	1.2							
	1.2.1							
002	2.0							
	2.1							
	2.1.1							
003	3.0							
	3.1							
	3.2							
004	4.0							
005	5.0							

Figure 5-7. Example of a Requirements Traceability Matrix

5.3 DEFINE SCOPE

Define Scope is the process of developing a detailed description of the project and product. The key benefit of this process is that it describes the product, service, or result boundaries and acceptance criteria. The inputs, tools and techniques, and outputs of this process are depicted in Figure 5-8. Figure 5-9 depicts the data flow diagram of the process.

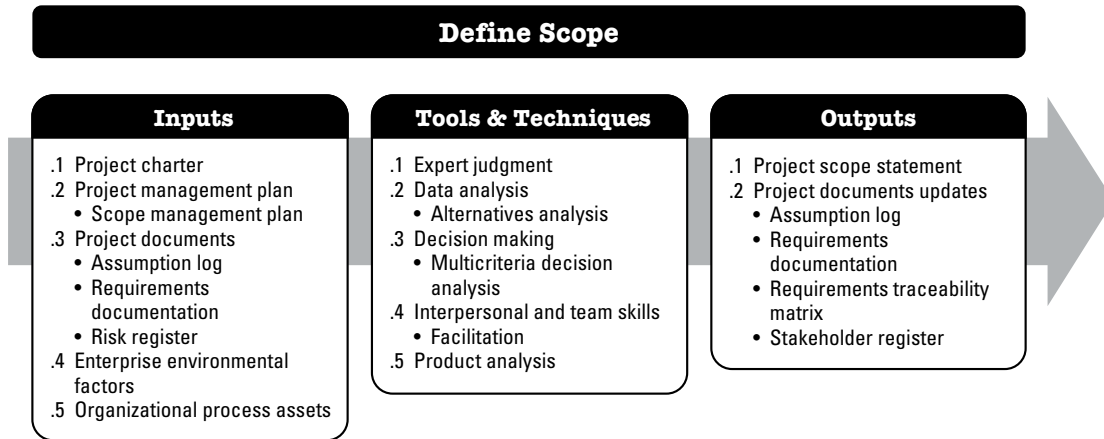

Figure 5-8. Define Scope: Inputs, Tools & Techniques, and Outputs

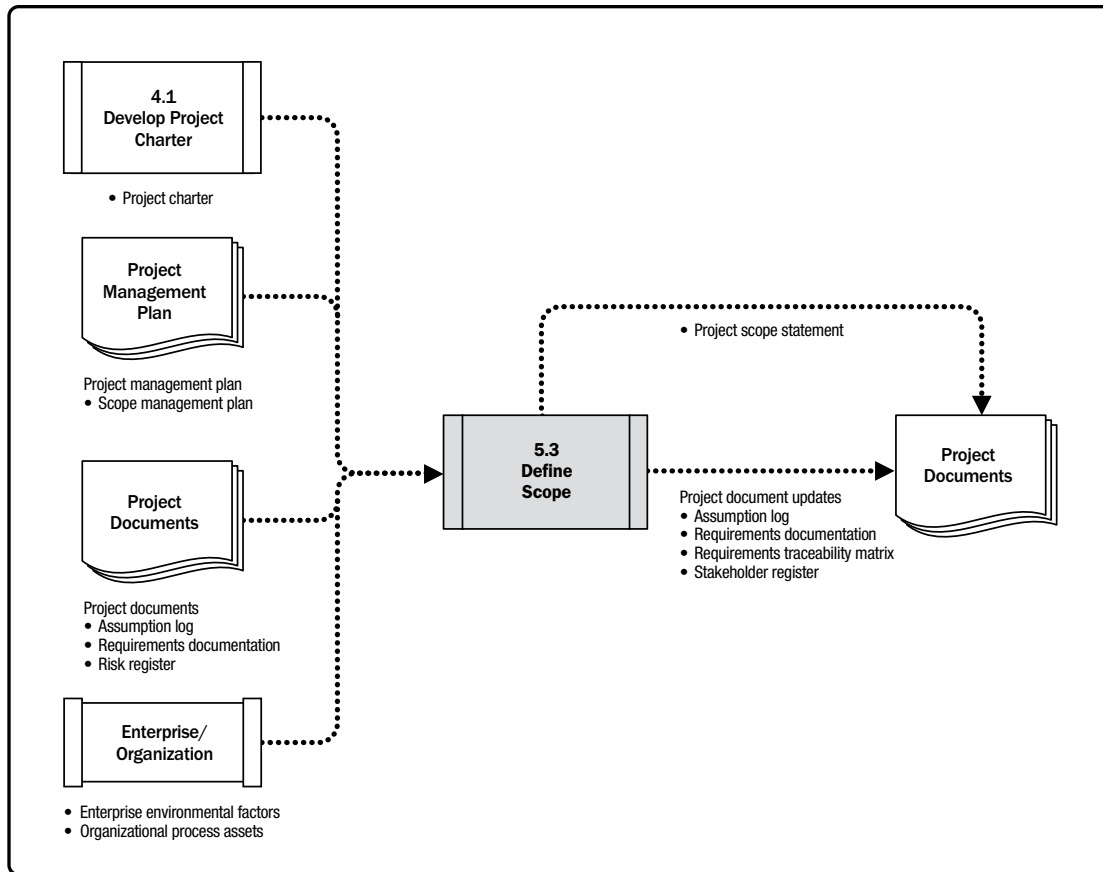

Figure 5-9. Define Scope: Data Flow Diagram

Since all the requirements identified in Collect Requirements may not be included in the project, the Define Scope process selects the final project requirements from the requirements documentation developed during the Collect Requirements process. It then develops a detailed description of the project and product, service, or result.

The preparation of a detailed project scope statement builds upon the major deliverables, assumptions, and constraints that are documented during project initiation. During project planning, the project scope is defined and described with greater specificity as more information about the project is known. Existing risks, assumptions, and constraints are analyzed for completeness and added or updated as necessary. The Define Scope process can be highly iterative. In iterative life cycle projects, a high-level vision will be developed for the overall project, but the detailed scope is determined one iteration at a time, and the detailed planning for the next iteration is carried out as work progresses on the current project scope and deliverables.

5.3.1 DEFINE SCOPE: INPUTS

5.3.1.1 PROJECT CHARTER

Described in Section 4.1.3.1. The project charter provides the high-level project description, product characteristics, and approval requirements.

5.3.1.2 PROJECT MANAGEMENT PLAN

Described in Section 4.2.3.1. A project management plan component includes but is not limited to the scope management plan as described in Section 5.1.3.1, which documents how the project scope will be defined, validated, and controlled.

5.3.1.3 PROJECT DOCUMENTS

Examples of project documents that can be considered as inputs for this process include but are not limited to:

- ◆ **Assumption log.** Described in Section 4.1.3.2. The assumption log identifies assumptions and constraints about the product, project, environment, stakeholders, and other factors that can influence the project and product scope.
- ◆ **Requirements documentation.** Described in Section 5.2.3.1. Requirements documentation identifies requirements that will be incorporated into the scope.
- ◆ **Risk register.** Described in Section 11.2.3.1. The risk register contains response strategies that may affect the project scope, such as reducing or changing project and product scope to avoid or mitigate a risk.

5.3.1.4 ENTERPRISE ENVIRONMENTAL FACTORS

The enterprise environmental factors that can influence the Define Scope process include but are not limited to:

- ◆ Organization's culture,
- ◆ Infrastructure,
- ◆ Personnel administration, and
- ◆ Marketplace conditions.

5.3.1.5 ORGANIZATIONAL PROCESS ASSETS

The organizational process assets that can influence the Define Scope process include but are not limited to:

- ◆ Policies, procedures, and templates for a project scope statement;
- ◆ Project files from previous projects; and
- ◆ Lessons learned from previous phases or projects.

5.3.2 DEFINE SCOPE: TOOLS AND TECHNIQUES

5.3.2.1 EXPERT JUDGMENT

Described in Section 4.1.2.1. Expertise should be considered from individuals or groups with knowledge of or experience with similar projects.

5.3.2.2 DATA ANALYSIS

An example of a data analysis technique that can be used in this process includes but is not limited to alternatives analysis. Alternatives analysis can be used to evaluate ways to meet the requirements and the objectives identified in the charter.

5.3.2.3 DECISION MAKING

Described in Section 5.1.2.2. A decision-making technique that can be used in this process includes but is not limited to multicriteria decision analysis. Described in Section 8.1.2.4, multicriteria decision analysis is a technique that uses a decision matrix to provide a systematic analytical approach for establishing criteria, such as requirements, schedule, budget, and resources, in order to refine the project and product scope for the project.

5.3.2.4 INTERPERSONAL AND TEAM SKILLS

Described in Section 4.1.2.3. An example of an interpersonal and team skills technique is facilitation. Facilitation is used in workshops and working sessions with key stakeholders who have a variety of expectations or fields of expertise. The goal is to reach a cross-functional and common understanding of the project deliverables and project and product boundaries.

5.3.2.5 PRODUCT ANALYSIS

Product analysis can be used to define products and services. It includes asking questions about a product or service and forming answers to describe the use, characteristics, and other relevant aspects of what is going to be delivered.

Each application area has one or more generally accepted methods for translating high-level product or service descriptions into meaningful deliverables. Requirements are captured at a high level and decomposed to the level of detail needed to design the final product. Examples of product analysis techniques include but are not limited to:

- ◆ Product breakdown,
- ◆ Requirements analysis,
- ◆ Systems analysis,
- ◆ Systems engineering,
- ◆ Value analysis, and
- ◆ Value engineering.

5.3.3 DEFINE SCOPE: OUTPUTS

5.3.3.1 PROJECT SCOPE STATEMENT

The project scope statement is the description of the project scope, major deliverables, assumptions, and constraints. The project scope statement documents the entire scope, including project and product scope. It describes the project's deliverables in detail. It also provides a common understanding of the project scope among project stakeholders. It may contain explicit scope exclusions that can assist in managing stakeholder expectations. It enables the project team to perform more detailed planning, guides the project team's work during execution, and provides the baseline for evaluating whether requests for changes or additional work are contained within or outside the project's boundaries.

The degree and level of detail to which the project scope statement defines the work that will be performed and the work that is excluded can help determine how well the project management team can control the overall project scope. The detailed project scope statement, either directly or by reference to other documents, includes the following:

- ◆ **Product scope description.** Progressively elaborates the characteristics of the product, service, or result described in the project charter and requirements documentation.
- ◆ **Deliverables.** Any unique and verifiable product, result, or capability to perform a service that is required to be produced to complete a process, phase, or project. Deliverables also include ancillary results, such as project management reports and documentation. These deliverables may be described at a summary level or in great detail.
- ◆ **Acceptance criteria.** A set of conditions that is required to be met before deliverables are accepted.
- ◆ **Project exclusions.** Identifies what is excluded from the project. Explicitly stating what is out of scope for the project helps manage stakeholders' expectations and can reduce scope creep.

Although the project charter and the project scope statement are sometimes perceived as containing a certain degree of redundancy, they are different in the level of detail contained in each. The project charter contains high-level information, while the project scope statement contains a detailed description of the scope components. These components are progressively elaborated throughout the project. Table 5-1 describes some of the key elements for each document.

Table 5-1. Elements of the Project Charter and Project Scope Statement

Project Charter	Project Scope Statement
<p>Project purpose</p> <p>Measurable project objectives and related success criteria</p> <p>High-level requirements</p> <p>High-level project description, boundaries, and key deliverables</p> <p>Overall project risk</p> <p>Summary milestone schedule</p> <p>Preapproved financial resources</p> <p>Key stakeholder list</p> <p>Project approval requirements (i.e., what constitutes success, who decides the project is successful, who signs off on the project)</p> <p>Project exit criteria (i.e., what are the conditions to be met in order to close or to cancel the project or phase)</p> <p>Assigned project manager, responsibility, and authority level</p> <p>Name and authority of the sponsor or other person(s) authorizing the project charter</p>	<p>Project scope description (progressively elaborated)</p> <p>Project deliverables</p> <p>Acceptance criteria</p> <p>Project exclusions</p>

5.3.3.2 PROJECT DOCUMENTS UPDATES

Project documents that may be updated as a result of carrying out this process include but are not limited to:

- ◆ **Assumption log.** Described in Section 4.1.3.2. The assumption log is updated with additional assumptions or constraints that were identified during this process.
- ◆ **Requirements documentation.** Described in Section 5.2.3.1. Requirements documentation may be updated with additional or changed requirements.
- ◆ **Requirements traceability matrix.** Described in Section 5.2.3.2. The requirements traceability matrix may be updated to reflect updates in requirement documentation.
- ◆ **Stakeholder register.** Described in Section 13.1.3.1. Where additional information on existing or new stakeholders is gathered as a result of this process, it is recorded in the stakeholder register.

5.4 CREATE WBS

Create WBS is the process of subdividing project deliverables and project work into smaller, more manageable components. The key benefit of this process is that it provides a framework of what has to be delivered. This process is performed once or at predefined points in the project. The inputs, tools and techniques, and outputs of this process are depicted in Figure 5-10. Figure 5-11 depicts the data flow diagram of the process.

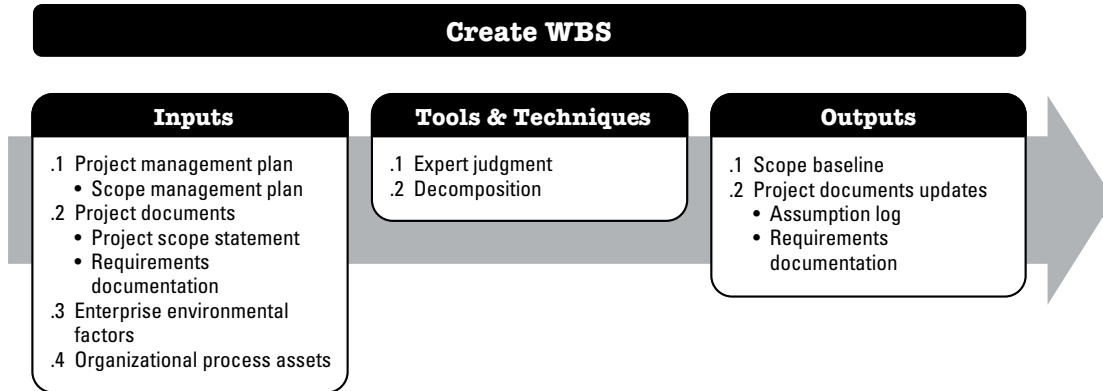

Figure 5-10. Create WBS: Inputs, Tools & Techniques, and Outputs

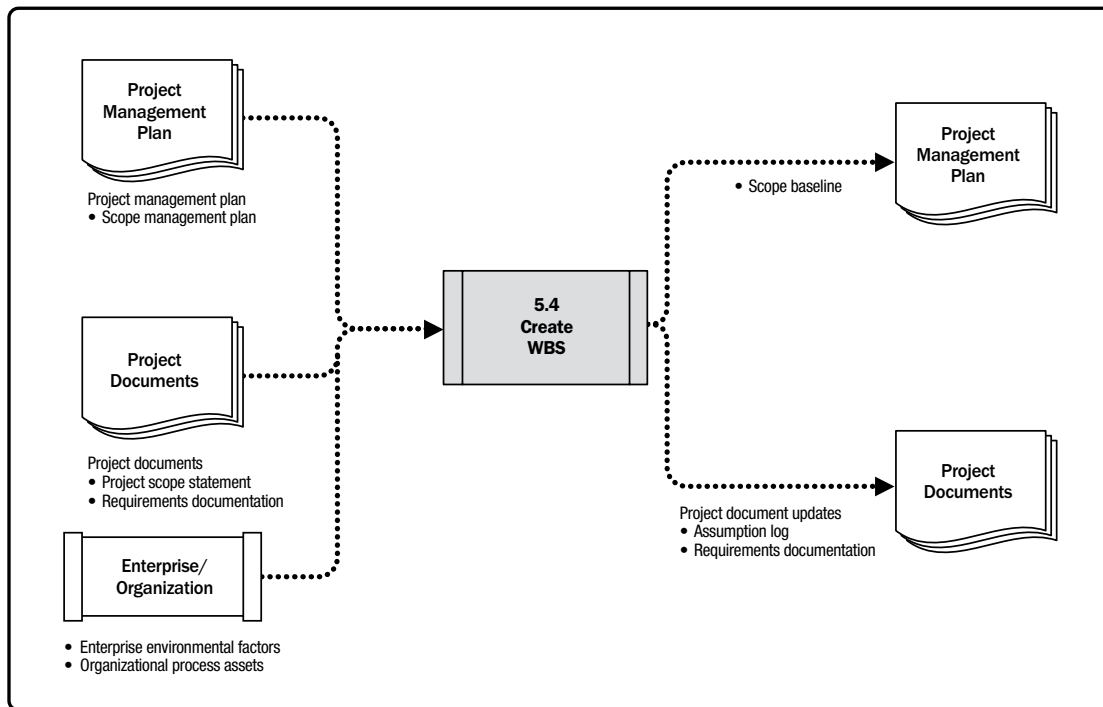

Figure 5-11. Create WBS: Data Flow Diagram

The WBS is a hierarchical decomposition of the total scope of work to be carried out by the project team to accomplish the project objectives and create the required deliverables. The WBS organizes and defines the total scope of the project and represents the work specified in the current approved project scope statement.

The planned work is contained within the lowest level of WBS components, which are called work packages. A work package can be used to group the activities where work is scheduled and estimated, monitored, and controlled. In the context of the WBS, work refers to work products or deliverables that are the result of activity and not to the activity itself.

5.4.1 CREATE WBS: INPUTS

5.4.1.1 PROJECT MANAGEMENT PLAN

A project management plan component includes but is not limited to the scope management plan. Described in Section 5.1.3.1, the scope management plan documents how the WBS will be created from the project scope statement.

5.4.1.2 PROJECT DOCUMENTS

Examples of project documents that can be considered as inputs for this process include but are not limited to:

- ◆ **Project scope statement.** Described in Section 5.3.3.1. The project scope statement describes the work that will be performed and the work that is excluded.
- ◆ **Requirements documentation.** Described in Section 5.2.3.1. Detailed requirements describe how individual requirements meet the business need for the project.

5.4.1.3 ENTERPRISE ENVIRONMENTAL FACTORS

The enterprise environmental factors that can influence the Create WBS process include but are not limited to industry-specific WBS standards that are relevant to the nature of the project. These industry-specific standards may serve as external reference sources for creating the WBS.

5.4.1.4 ORGANIZATIONAL PROCESS ASSETS

The organizational process assets that can influence the Create WBS process include but are not limited to:

- ◆ Policies, procedures, and templates for the WBS;
- ◆ Project files from previous projects; and
- ◆ Lessons learned from previous projects.

5.4.2 CREATE WBS: TOOLS AND TECHNIQUES

5.4.2.1 EXPERT JUDGMENT

Described in Section 4.1.2.1. Expertise should be considered from individuals or groups with knowledge of or experience with similar projects.

5.4.2.2 DECOMPOSITION

Decomposition is a technique used for dividing and subdividing the project scope and project deliverables into smaller, more manageable parts. The work package is the work defined at the lowest level of the WBS for which cost and duration can be estimated and managed. The level of decomposition is often guided by the degree of control needed to effectively manage the project. The level of detail for work packages will vary with the size and complexity of the project. Decomposition of the total project work into work packages generally involves the following activities:

- ◆ Identifying and analyzing the deliverables and related work,
- ◆ Structuring and organizing the WBS,
- ◆ Decomposing the upper WBS levels into lower-level detailed components,
- ◆ Developing and assigning identification codes to the WBS components, and
- ◆ Verifying that the degree of decomposition of the deliverables is appropriate.

A portion of a WBS with some branches of the WBS decomposed down through the work package level is shown in Figure 5-12.

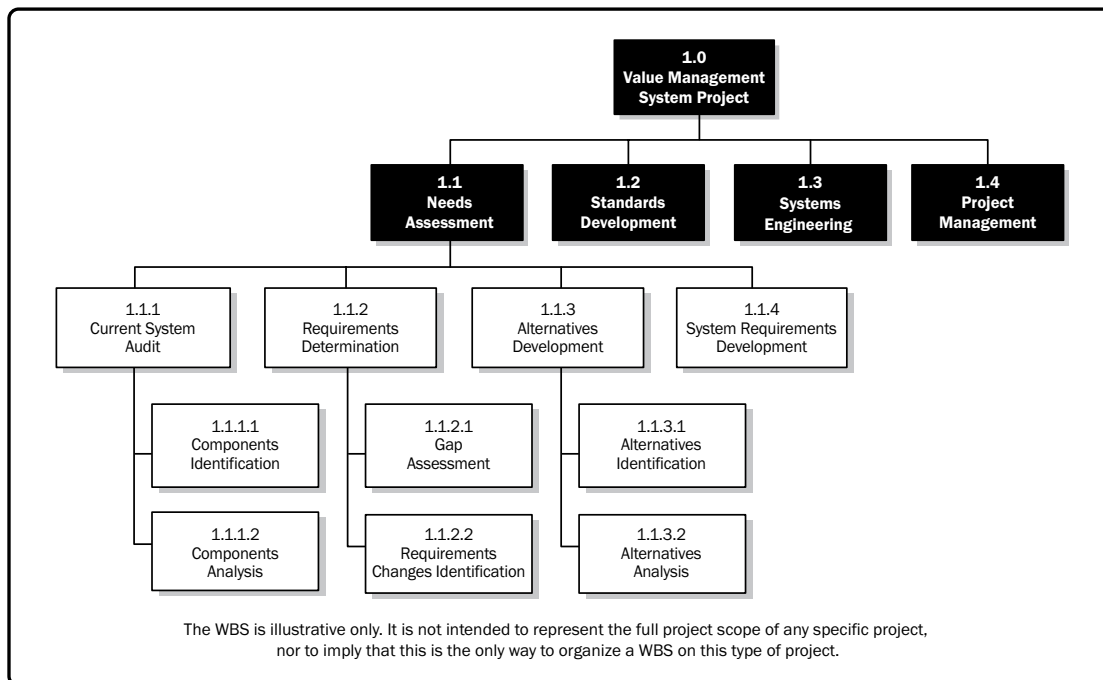

Figure 5-12. Sample WBS Decomposed Down Through Work Packages

A WBS structure may be created through various approaches. Some of the popular methods include the top-down approach, the use of organization-specific guidelines, and the use of WBS templates. A bottom-up approach can be used to group subcomponents. The WBS structure can be represented in a number of forms, such as:

- ◆ Using phases of the project life cycle as the second level of decomposition, with the product and project deliverables inserted at the third level, as shown in Figure 5-13;
- ◆ Using major deliverables as the second level of decomposition, as shown in Figure 5-14; and
- ◆ Incorporating subcomponents that may be developed by organizations outside the project team, such as contracted work. The seller then develops the supporting contract WBS as part of the contracted work.

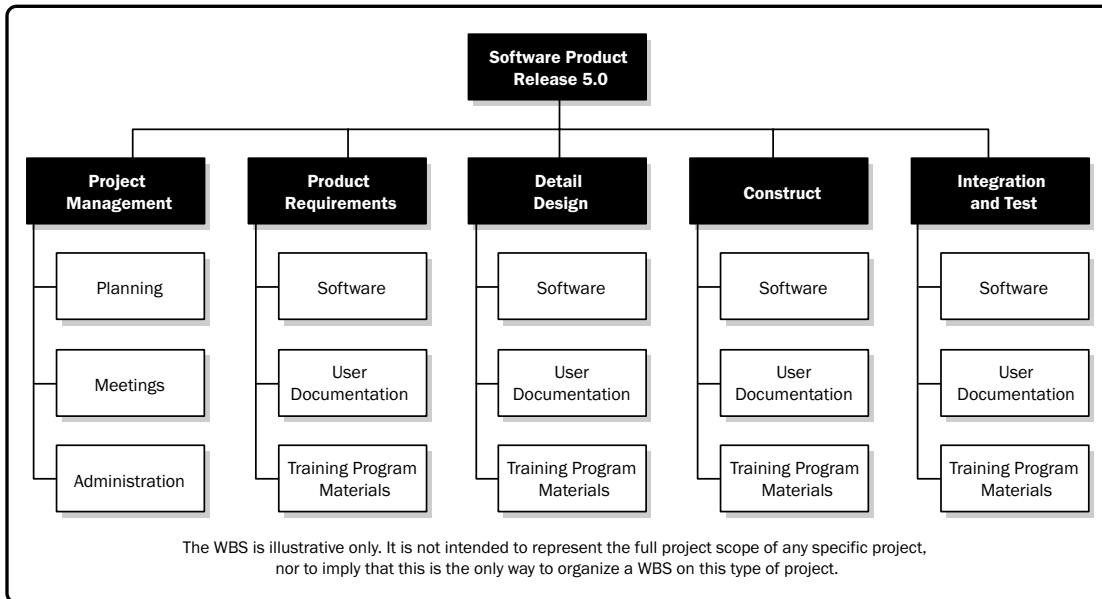

Figure 5-13. Sample WBS Organized by Phase

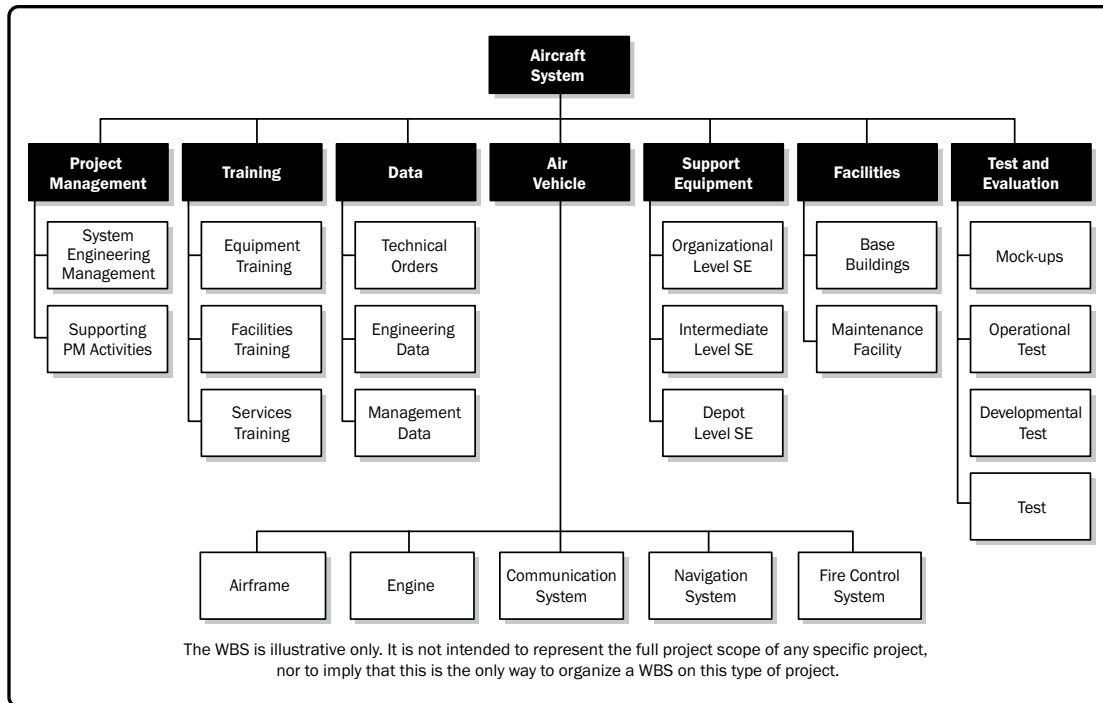

Figure 5-14. Sample WBS with Major Deliverables

Decomposition of the upper-level WBS components requires subdividing the work for each of the deliverables or subcomponents into its most fundamental components, where the WBS components represent verifiable products, services, or results. If an agile approach is used, epics can be decomposed into user stories. The WBS may be structured as an outline, an organizational chart, or other method that identifies a hierarchical breakdown. Verifying the correctness of the decomposition requires determining that the lower-level WBS components are those that are necessary and sufficient for completion of the corresponding higher-level deliverables. Different deliverables can have different levels of decomposition. To arrive at a work package, the work for some deliverables needs to be decomposed only to the next level, while others need additional levels of decomposition. As the work is decomposed to greater levels of detail, the ability to plan, manage, and control the work is enhanced. However, excessive decomposition can lead to nonproductive management effort, inefficient use of resources, decreased efficiency in performing the work, and difficulty aggregating data over different levels of the WBS.

Decomposition may not be possible for a deliverable or subcomponent that will be accomplished far into the future. The project management team usually waits until the deliverable or subcomponent is agreed on, so the details of the WBS can be developed. This technique is sometimes referred to as rolling wave planning.

The WBS represents all product and project work, including the project management work. The total of the work at the lowest levels should roll up to the higher levels so that nothing is left out and no extra work is performed. This is sometimes called the 100 percent rule.

For specific information regarding the WBS, refer to the *Practice Standard for Work Breakdown Structures – Second Edition* [15]. This standard contains industry-specific examples of WBS templates that can be tailored to specific projects in a particular application area.

5.4.3 CREATE WBS: OUTPUTS

5.4.3.1 SCOPE BASELINE

The scope baseline is the approved version of a scope statement, WBS, and its associated WBS dictionary, which can be changed only through formal change control procedures and is used as a basis for comparison. It is a component of the project management plan. Components of the scope baseline include:

- ◆ **Project scope statement.** The project scope statement includes the description of the project scope, major deliverables, assumptions, and constraints (Section 5.3.3.1).
- ◆ **WBS.** The WBS is a hierarchical decomposition of the total scope of work to be carried out by the project team to accomplish the project objectives and create the required deliverables. Each descending level of the WBS represents an increasingly detailed definition of the project work.
- ◆ **Work package.** The lowest level of the WBS is a work package with a unique identifier. These identifiers provide a structure for hierarchical summation of costs, schedule, and resource information and form a code of accounts. Each work package is part of a control account. A control account is a management control point where scope, budget, and schedule are integrated and compared to the earned value for performance measurement. A control account has two or more work packages, though each work package is associated with a single control account.
- ◆ **Planning package.** A control account may include one or more planning packages. A planning package is a work breakdown structure component below the control account and above the work package with known work content but without detailed schedule activities.

- ◆ **WBS dictionary.** The WBS dictionary is a document that provides detailed deliverable, activity, and scheduling information about each component in the WBS. The WBS dictionary is a document that supports the WBS. Most of the information included in the WBS dictionary is created by other processes and added to this document at a later stage. Information in the WBS dictionary may include but is not limited to:
 - Code of account identifier,
 - Description of work,
 - Assumptions and constraints,
 - Responsible organization,
 - Schedule milestones,
 - Associated schedule activities,
 - Resources required,
 - Cost estimates,
 - Quality requirements,
 - Acceptance criteria,
 - Technical references, and
 - Agreement information.

5.4.3.2 PROJECT DOCUMENTS UPDATES

Project documents that may be updated as a result of carrying out this process include but are not limited to:

- **Assumption log.** Described in Section 4.1.3.2. The assumption log is updated with additional assumptions or constraints that were identified during the Create WBS process.
- **Requirements documentation.** Described in Section 5.2.3.1. Requirements documentation may be updated to include approved changes resulting from the Create WBS process.

5.5 VALIDATE SCOPE

Validate Scope is the process of formalizing acceptance of the completed project deliverables. The key benefit of this process is that it brings objectivity to the acceptance process and increases the probability of final product, service, or result acceptance by validating each deliverable. This process is performed periodically throughout the project as needed. The inputs, tools and techniques, and outputs of this process are depicted in Figure 5-15. Figure 5-16 depicts the data flow diagram of the process.

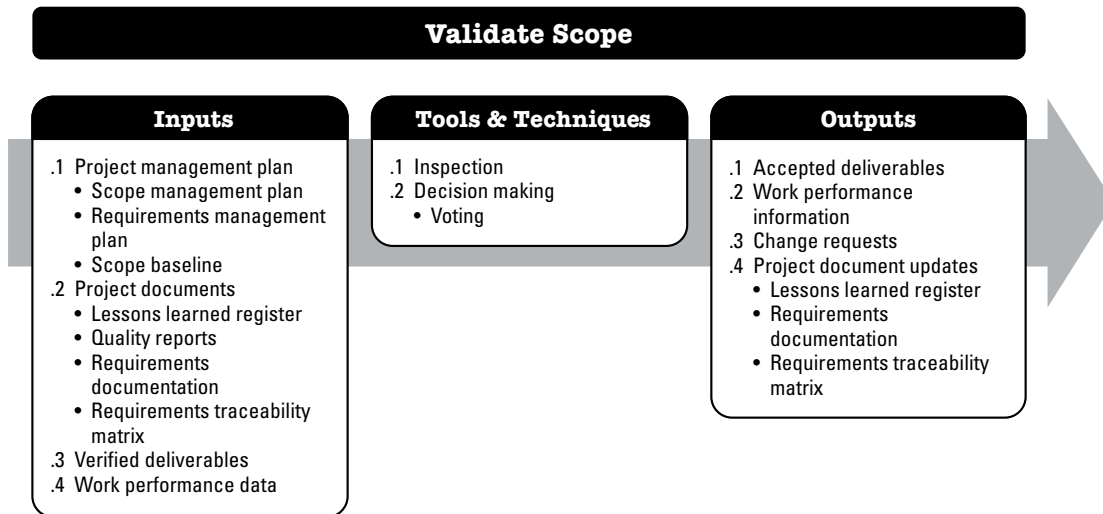

Figure 5-15. Validate Scope: Inputs, Tools & Techniques, and Outputs

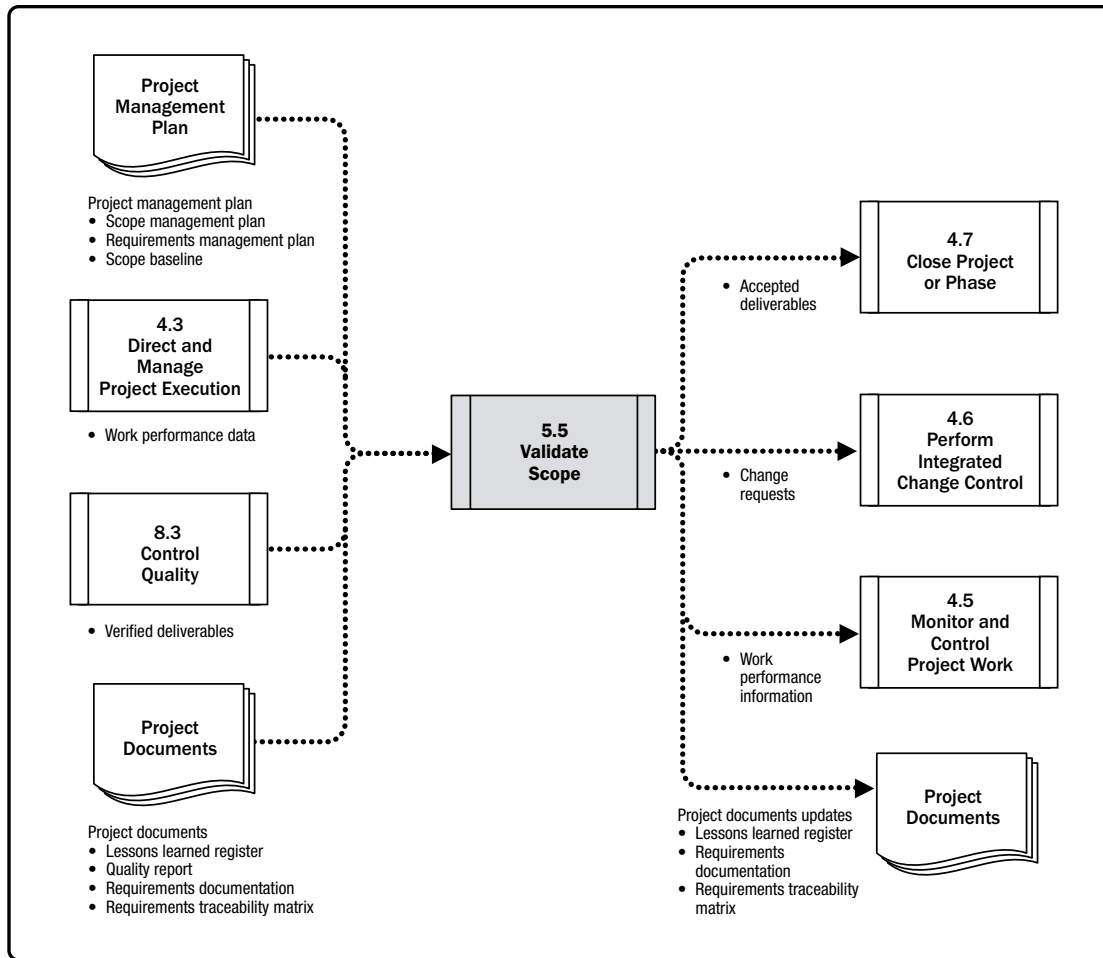

Figure 5-16. Validate Scope: Data Flow Diagram

The verified deliverables obtained from the Control Quality process are reviewed with the customer or sponsor to ensure they are completed satisfactorily and have received formal acceptance of the deliverables by the customer or sponsor. In this process, the outputs obtained as a result of the Planning processes in the Project Scope Management Knowledge Area, such as the requirements documentation or the scope baseline, as well as the work performance data obtained from the Execution processes in other Knowledge Areas, are the basis for performing the validation and for final acceptance.

The Validate Scope process differs from the Control Quality process in that the former is primarily concerned with acceptance of the deliverables, while the latter is primarily concerned with correctness of the deliverables and meeting the quality requirements specified for the deliverables. Control Quality is generally performed before Validate Scope, although the two processes may be performed in parallel.

5.5.1 VALIDATE SCOPE: INPUTS

5.5.1.1 PROJECT MANAGEMENT PLAN

Described in Section 4.2.3.1. Project management plan components include but are not limited to:

- ◆ **Scope management plan.** Described in Section 5.1.3.1. The project management plan specifies how formal acceptance of the completed project deliverables will be obtained.
- ◆ **Requirements management plan.** Described in Section 5.1.3.2. The requirements management plan describes how the project requirements are validated.
- ◆ **Scope baseline.** Described in Section 5.4.3.1. The scope baseline is compared to actual results to determine if a change, corrective action, or preventive action is necessary.

5.5.1.2 PROJECT DOCUMENTS

Project documents that can be considered as inputs for this process include but are not limited to:

- ◆ **Lessons learned register:** Described in Section 4.4.3.1. Lessons learned earlier in the project can be applied to later phases in the project to improve the efficiency and effectiveness of validating deliverables.
- ◆ **Quality reports.** Described in Section 8.2.3.1. The information presented in the quality report may include all quality assurance issues managed or escalated by the team, recommendations for improvement, and the summary of findings from the Control Quality process. This information is reviewed prior to product acceptance.
- ◆ **Requirements documentation.** Described in Section 5.2.3.1. Requirements are compared to the actual results to determine if a change, corrective action, or preventive action is necessary.
- ◆ **Requirements traceability matrix.** Described in Section 5.2.3.2. The requirements traceability matrix contains information about requirements, including how they will be validated.

5.5.1.3 VERIFIED DELIVERABLES

Verified deliverables are project deliverables that are completed and checked for correctness through the Control Quality process.

5.5.1.4 WORK PERFORMANCE DATA

Described in Section 4.3.3.2. Work performance data can include the degree of compliance with requirements, number of nonconformities, severity of the nonconformities, or the number of validation cycles performed in a period of time.

5.5.2 VALIDATE SCOPE: TOOLS AND TECHNIQUES

5.5.2.1 INSPECTION

Described in Section 8.3.2.3. Inspection includes activities such as measuring, examining, and validating to determine whether work and deliverables meet requirements and product acceptance criteria. Inspections are sometimes called reviews, product reviews, and walkthroughs. In some application areas, these different terms have unique and specific meanings.

5.5.2.2 DECISION MAKING

Described in Section 5.2.2.4. An example of decision making that may be used in this process includes but is not limited to voting. Voting is used to reach a conclusion when the validation is performed by the project team and other stakeholders.

5.5.3 VALIDATE SCOPE: OUTPUTS

5.5.3.1 ACCEPTED DELIVERABLES

Deliverables that meet the acceptance criteria are formally signed off and approved by the customer or sponsor. Formal documentation received from the customer or sponsor acknowledging formal stakeholder acceptance of the project's deliverables is forwarded to the Close Project or Phase process (Section 4.7).

5.5.3.2 WORK PERFORMANCE INFORMATION

Work performance information includes information about project progress, such as which deliverables have been accepted and which have not been accepted and the reasons why. This information is documented as described in Section 10.3.3.1 and communicated to stakeholders.

5.5.3.3 CHANGE REQUESTS

The completed deliverables that have not been formally accepted are documented, along with the reasons for non-acceptance of those deliverables. Those deliverables may require a change request for defect repair. The change requests (described in Section 4.3.3.4) are processed for review and disposition through the Perform Integrated Change Control process (Section 4.6).

5.5.3.4 PROJECT DOCUMENTS UPDATES

Project documents that may be updated as a result of carrying out this process include but are not limited to:

- ◆ **Lessons learned register.** Described in Section 4.4.3.1. The lessons learned register is updated with information on challenges encountered and how they could have been avoided as well as approaches that worked well for validating deliverables.
- ◆ **Requirements documentation.** Described in Section 5.2.3.1. The requirements documentation may be updated with the actual results of validation activity. Of particular interest is when the actual results are better than the requirement or where a requirement was waived.
- ◆ **Requirements traceability matrix.** Described in Section 5.2.3.2. The requirements traceability matrix is updated with the results of the validation, including the method used and the outcome.

5.6 CONTROL SCOPE

Control Scope is the process of monitoring the status of the project and product scope and managing changes to the scope baseline. The key benefit of this process is that the scope baseline is maintained throughout the project. This process is performed throughout the project. The inputs, tools and techniques, and outputs of this process are depicted in Figure 5-17. Figure 5-18 depicts the data flow diagram of the process.

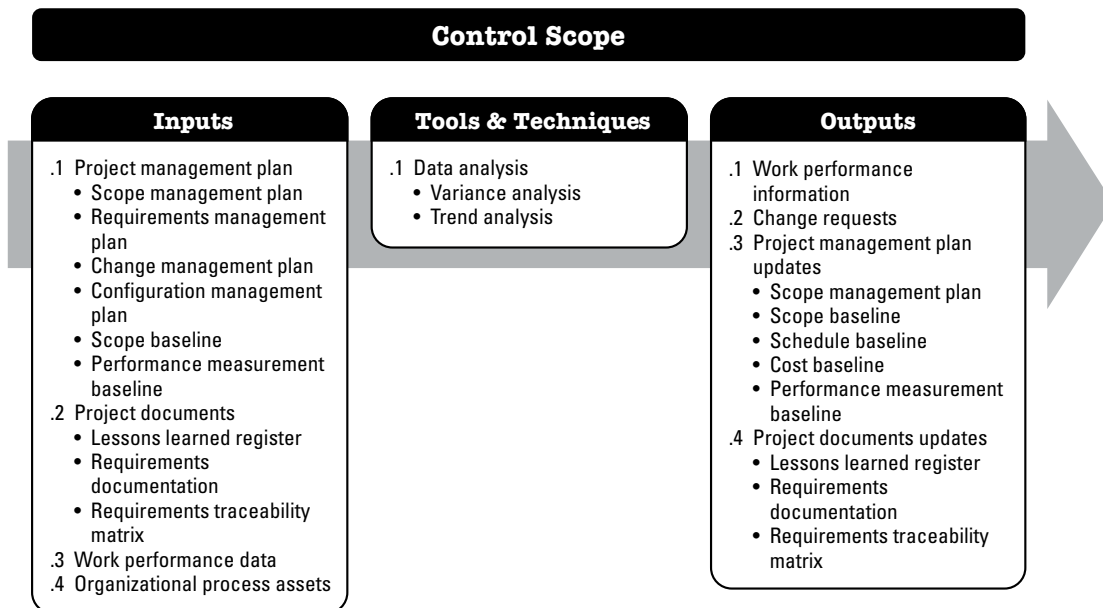

Figure 5-17. Control Scope: Inputs, Tools & Techniques, and Outputs

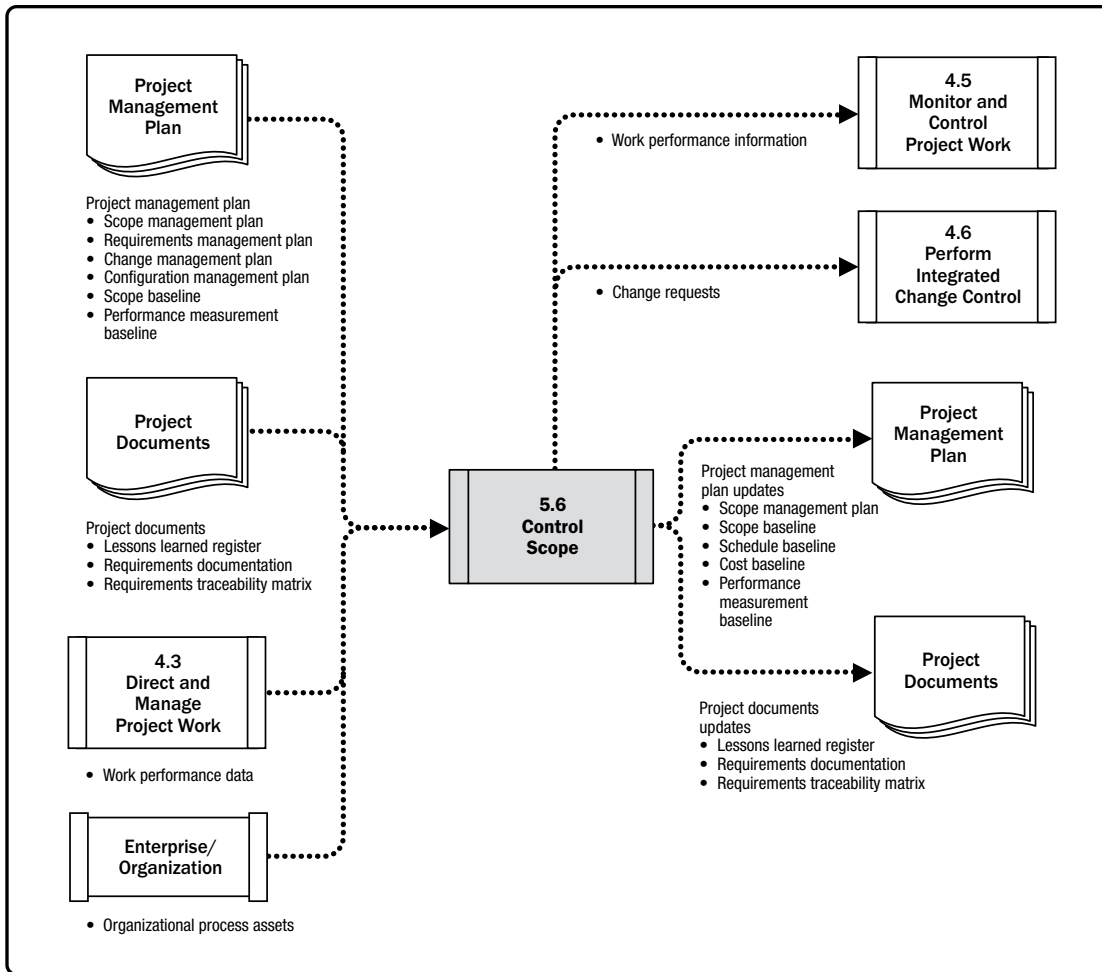

Figure 5-18. Control Scope: Data Flow Diagram

Controlling the project scope ensures all requested changes and recommended corrective or preventive actions are processed through the Perform Integrated Change Control process (see Section 4.6). Control Scope is also used to manage the actual changes when they occur and is integrated with the other control processes. The uncontrolled expansion to product or project scope without adjustments to time, cost, and resources is referred to as scope creep. Change is inevitable; therefore, some type of change control process is mandatory for every project.

5.6.1 CONTROL SCOPE: INPUTS

5.6.1.1 PROJECT MANAGEMENT PLAN

Described in Section 4.2.3.1. Project management plan components include but are not limited to:

- ◆ **Scope management plan.** Described in Section 5.1.3.1. The scope management plan documents how the project and product scope will be controlled.
- ◆ **Requirements management plan.** Described in Section 5.1.3.2. The requirements management plan describes how the project requirements will be managed.
- ◆ **Change management plan.** Described in Section 4.2.3.1. The change management plan defines the process for managing change on the project.
- ◆ **Configuration management plan.** Described in Section 4.2.3.1. The configuration management plan defines those items that are configurable, those items that require formal change control, and the process for controlling changes to such items.
- ◆ **Scope baseline.** Described in Section 5.4.3.1. The scope baseline is compared to actual results to determine if a change, corrective action, or preventive action is necessary.
- ◆ **Performance measurement baseline.** Described in Section 4.2.3.1. When using earned value analysis, the performance measurement baseline is compared to actual results to determine if a change, corrective action, or preventive action is necessary.

5.6.1.2 PROJECT DOCUMENTS

Project documents that can be considered as inputs for this process include but are not limited to:

- ◆ **Lessons learned register.** Described in Section 4.4.3.1. Lessons learned earlier in the project can be applied to later phases in the project to improve scope control.
- ◆ **Requirements documentation.** Described in Section 5.2.3.1. Requirements documentation is used to detect any deviation in the agreed-upon scope for the project or product.
- ◆ **Requirements traceability matrix.** Described in Section 5.2.3.2. The requirements traceability matrix helps to detect the impact of any change or deviation from the scope baseline on the project objectives. It may also provide status of requirements being controlled.

5.6.1.3 WORK PERFORMANCE DATA

Work performance data can include the number of change requests received, the number of requests accepted, and the number of deliverables verified, validated, and completed.

5.6.1.4 ORGANIZATIONAL PROCESS ASSETS

The organizational process assets that can influence the Control Scope process include but are not limited to:

- ◆ Existing formal and informal scope, control-related policies, procedures, guidelines; and
- ◆ Monitoring and reporting methods and templates to be used.

5.6.2 CONTROL SCOPE: TOOLS AND TECHNIQUES

5.6.2.1 DATA ANALYSIS

Data analysis techniques that can be used in the Control Scope process include but are not limited to:

- ◆ **Variance analysis.** Described in Section 4.5.2.2. Variance analysis is used to compare the baseline to the actual results and determine if the variance is within the threshold amount or if corrective or preventive action is appropriate.
- ◆ **Trend analysis.** Described in Section 4.5.2.2. Trend analysis examines project performance over time to determine if performance is improving or deteriorating.

Important aspects of project scope control include determining the cause and degree of variance relative to the scope baseline (Section 5.4.3.1) and deciding whether corrective or preventive action is required.

5.6.3 CONTROL SCOPE: OUTPUTS

5.6.3.1 WORK PERFORMANCE INFORMATION

Work performance information produced includes correlated and contextualized information on how the project and product scope are performing compared to the scope baseline. It can include the categories of the changes received, the identified scope variances and their causes, how they impact schedule or cost, and the forecast of the future scope performance.

5.6.3.2 CHANGE REQUESTS

Described in Section 4.3.3.4. Analysis of project performance may result in a change request to the scope and schedule baselines or other components of the project management plan. Change requests are processed for review and disposition through the Perform Integrated Change Control process (Section 4.6).

5.6.3.3 PROJECT MANAGEMENT PLAN UPDATES

Any change to the project management plan goes through the organization's change control process via a change request. Components that may require a change request for the project management plan include but are not limited to:

- ◆ **Scope management plan.** Described in Section 5.1.3.1. The scope management plan may be updated to reflect a change in how the scope is managed.
- ◆ **Scope baseline.** Described in Section 5.4.3.1. Changes to the scope baseline are incorporated in response to approved changes in scope, scope statement, the WBS, or the WBS dictionary. In some cases, scope variances can be so severe that a revised scope baseline is needed to provide a realistic basis for performance measurement.
- ◆ **Schedule baseline.** Described in Section 6.5.3.1. Changes to the schedule baseline are incorporated in response to approved changes in scope, resources, or schedule estimates. In some cases, schedule variances can be so severe that a revised schedule baseline is needed to provide a realistic basis for performance measurement.
- ◆ **Cost baseline.** Described in Section 7.3.3.1. Changes to the cost baseline are incorporated in response to approved changes in scope, resources, or cost estimates. In some cases, cost variances can be so severe that a revised cost baseline is needed to provide a realistic basis for performance measurement.
- ◆ **Performance measurement baseline.** Described in Section 4.2.3.1. Changes to the performance measurement baseline are incorporated in response to approved changes in scope, schedule performance, or cost estimates. In some cases, the performance variances can be so severe that a change request is put forth to revise the performance measurement baseline to provide a realistic basis for performance measurement.

5.6.3.4 PROJECT DOCUMENTS UPDATES

Project documents that may be updated as a result of carrying out this process include but are not limited to:

- ◆ **Lessons learned register.** Described in Section 4.4.3.1. The lessons learned register can be updated with techniques that are efficient and effective in controlling scope, including causes of variances and corrective actions chosen.
- ◆ **Requirements documentation.** Described in Section 5.2.3.1. Requirements documentation may be updated with additional or changed requirements.
- ◆ **Requirements traceability matrix.** Described in Section 5.2.3.2. The requirements traceability matrix may be updated to reflect updates in requirement documentation.



6

PROJECT SCHEDULE MANAGEMENT

Project Schedule Management includes the processes required to manage the timely completion of the project. The Project Schedule Management processes are:

6.1 Plan Schedule Management—The process of establishing the policies, procedures, and documentation for planning, developing, managing, executing, and controlling the project schedule.

6.2 Define Activities—The process of identifying and documenting the specific actions to be performed to produce the project deliverables.

6.3 Sequence Activities—The process of identifying and documenting relationships among the project activities.

6.4 Estimate Activity Durations—The process of estimating the number of work periods needed to complete individual activities with the estimated resources.

6.5 Develop Schedule—The process of analyzing activity sequences, durations, resource requirements, and schedule constraints to create the project schedule model for project execution and monitoring and controlling.

6.6 Control Schedule—The process of monitoring the status of the project to update the project schedule and manage changes to the schedule baseline.

Figure 6-1 provides an overview of the Project Schedule Management processes. The Project Schedule Management processes are presented as discrete processes with defined interfaces while, in practice, they overlap and interact in ways that cannot be completely detailed in the *PMBOK® Guide*.





Figure 6-1. Project Schedule Management Overview

KEY CONCEPTS FOR PROJECT SCHEDULE MANAGEMENT

Project scheduling provides a detailed plan that represents how and when the project will deliver the products, services, and results defined in the project scope and serves as a tool for communication, managing stakeholders' expectations, and as a basis for performance reporting.

The project management team selects a scheduling method, such as critical path or an agile approach. Then, the project-specific data, such as the activities, planned dates, durations, resources, dependencies, and constraints, are entered into a scheduling tool to create a schedule model for the project. The result is a project schedule. Figure 6-2 provides a scheduling overview that shows how the scheduling method, scheduling tool, and outputs from the Project Schedule Management processes interact to create a schedule model.

For smaller projects, defining activities, sequencing activities, estimating activity durations, and developing the schedule model are so tightly linked that they are viewed as a single process that can be performed by a person over a relatively short period of time. These processes are presented here as distinct elements because the tools and techniques for each process are different. Some of these processes are presented more fully in the *Practice Standard for Scheduling* [2].

When possible, the detailed project schedule should remain flexible throughout the project to adjust for knowledge gained, increased understanding of the risk, and value-added activities.



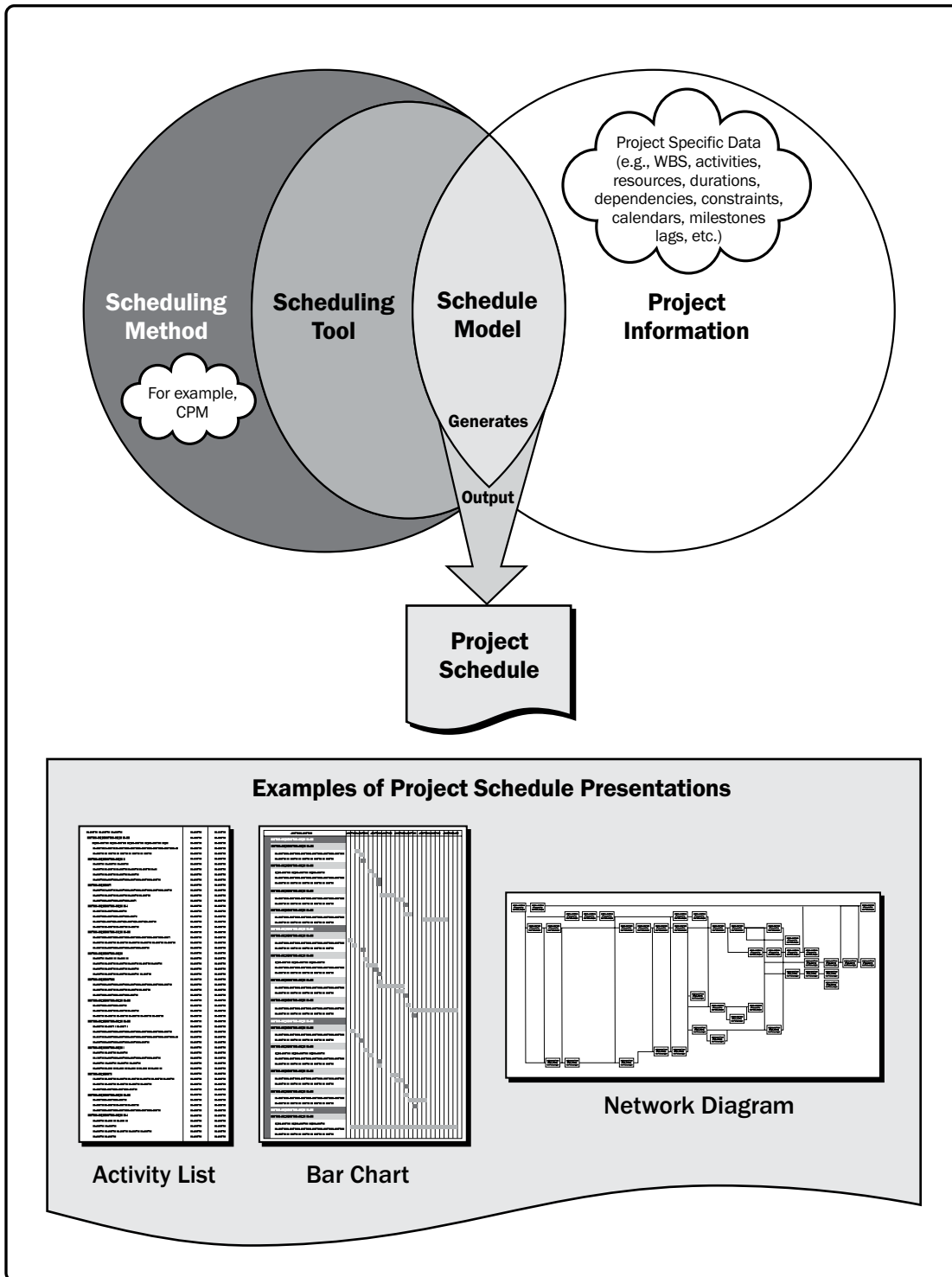

Figure 6-2. Scheduling Overview

TRENDS AND EMERGING PRACTICES IN PROJECT SCHEDULE MANAGEMENT

With high levels of uncertainty and unpredictability in a fast-paced, highly competitive global marketplace where long term scope is difficult to define, it is becoming even more important to have a contextual framework for effective adoption and tailoring of development practices to respond to the changing needs of the environment. Adaptive planning defines a plan but acknowledges that once work starts, the priorities may change and the plan needs to reflect this new knowledge.

Some of the emerging practices for project scheduling methods include but are not limited to:

- ◆ **Iterative scheduling with a backlog.** This is a form of rolling wave planning based on adaptive life cycles, such as the agile approach for product development. The requirements are documented in user stories that are then prioritized and refined just prior to construction, and the product features are developed using time-boxed periods of work. This approach is often used to deliver incremental value to the customer or when multiple teams can concurrently develop a large number of features that have few interconnected dependencies. This scheduling method is appropriate for many projects as indicated by the widespread and growing use of adaptive life cycles for product development. The benefit of this approach is that it welcomes changes throughout the development life cycle.
- ◆ **On-demand scheduling.** This approach, typically used in a Kanban system, is based on the theory-of-constraints and pull-based scheduling concepts from lean manufacturing to limit a team's work in progress in order to balance demand against the team's delivery throughput. On-demand scheduling does not rely on a schedule that was developed previously for the development of the product or product increments, but rather pulls work from a backlog or intermediate queue of work to be done immediately as resources become available. On-demand scheduling is often used for projects that evolve the product incrementally in operational or sustainment environments, and where tasks may be made relatively similar in size and scope or can be bundled by size and scope.

TAILORING CONSIDERATIONS

Because each project is unique, the project manager may need to tailor the way Project Schedule Management processes are applied. Considerations for tailoring include but are not limited to:

- ◆ **Life cycle approach.** What is the most appropriate life cycle approach that allows for a more detailed schedule?
- ◆ **Resource availability.** What are the factors influencing durations (such as the correlation between available resources and their productivity)?
- ◆ **Project dimensions.** How will the presence of project complexity, technological uncertainty, product novelty, pace, or progress tracking (such as earned value, percentage complete, red-yellow-green (stop light) indicators) impact the desired level of control?
- ◆ **Technology support.** Is technology used to develop, record, transmit, receive, and store project schedule model information and is it readily accessible?

For more specific information regarding scheduling, refer to the *Practice Standard for Scheduling* [16].

CONSIDERATIONS FOR AGILE/ADAPTIVE ENVIRONMENTS

Adaptive approaches use short cycles to undertake work, review the results, and adapt as necessary. These cycles provide rapid feedback on the approaches and suitability of deliverables, and generally manifest as iterative scheduling and on-demand, pull-based scheduling, as discussed in the section on Key Trends and Emerging Practices in Project Schedule Management.

In large organizations, there may be a mixture of small projects and large initiatives requiring long-term roadmaps to manage the development of these programs using scaling factors (e.g., team size, geographical distribution, regulatory compliance, organizational complexity, and technical complexity). To address the full delivery life cycle for larger, enterprise-wide systems, a range of techniques utilizing a predictive approach, adaptive approach, or a hybrid of both, may need to be adopted. The organization may need to combine practices from several core methods, or adopt a method that has already done so, and adopt a few principles and practices of more traditional techniques.

The role of the project manager does not change based on managing projects using a predictive development life cycle or managing projects in adaptive environments. However, to be successful in using adaptive approaches, the project manager will need to be familiar with the tools and techniques to understand how to apply them effectively.

6.1 PLAN SCHEDULE MANAGEMENT

Plan Schedule Management is the process of establishing the policies, procedures, and documentation for planning, developing, managing, executing, and controlling the project schedule. The key benefit of this process is that it provides guidance and direction on how the project schedule will be managed throughout the project. This process is performed once or at predefined points in the project. The inputs, tools and techniques, and outputs of the process are depicted in Figure 6-3. Figure 6-4 depicts the data flow diagram for the process.

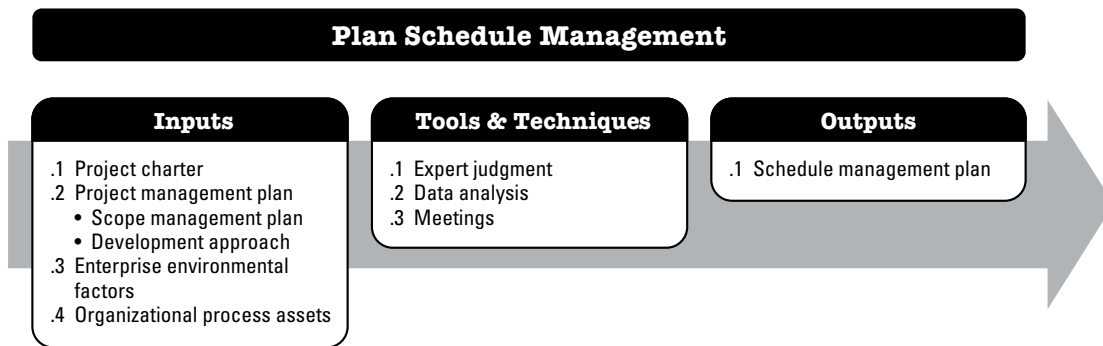

Figure 6-3. Plan Schedule Management: Inputs, Tools & Techniques, and Outputs

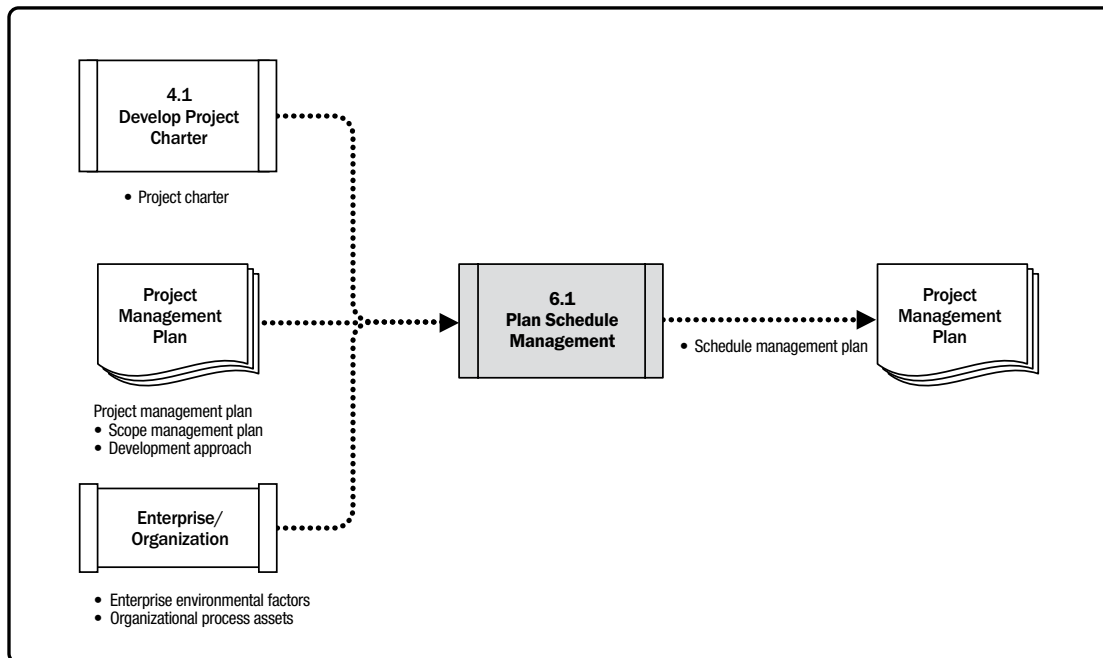

Figure 6-4. Plan Schedule Management: Data Flow Diagram

6.1.1 PLAN SCHEDULE MANAGEMENT: INPUTS

6.1.1.1 PROJECT CHARTER

Described in Section 4.1.3.1. The project charter defines the summary milestone schedule that will influence the management of the project schedule.

6.1.1.2 PROJECT MANAGEMENT PLAN

Described in Section 4.3.2.1. Project management plan components include but are not limited to:

- ◆ **Scope management plan.** Described in Section 5.1.3.1. The scope management plan describes how the scope will be defined and developed, which will provide information on how the schedule will be developed.
- ◆ **Development approach.** Described in Section 4.2.3.1. The product development approach will help define the scheduling approach, estimating techniques, scheduling tools, and techniques for controlling the schedule.

6.1.1.3 ENTERPRISE ENVIRONMENTAL FACTORS

The enterprise environmental factors that can influence the Plan Schedule Management process include but are not limited to:

- ◆ Organizational culture and structure,
- ◆ Team resource availability and skills and physical resource availability,
- ◆ Scheduling software,
- ◆ Guidelines and criteria for tailoring the organization's set of standard processes and procedures to satisfy the specific needs of the project, and
- ◆ Commercial databases, such as standardized estimating data.

6.1.1.4 ORGANIZATIONAL PROCESS ASSETS

The organizational process assets that can influence the Plan Schedule Management process include but are not limited to:

- ◆ Historical information and lessons learned repositories;
- ◆ Existing formal and informal schedule development, management- and control-related policies, procedures, and guidelines;
- ◆ Templates and forms; and
- ◆ Monitoring and reporting tools.

6.1.2 PLAN SCHEDULE MANAGEMENT: TOOLS AND TECHNIQUES

6.1.2.1 EXPERT JUDGMENT

Described in Section 4.1.2.1 Expertise should be considered from individuals or groups with specialized knowledge or training in previous, similar projects:

- ◆ Schedule development, management, and control;
- ◆ Scheduling methodologies (e.g., predictive or adaptive life cycle);
- ◆ Scheduling software; and
- ◆ The specific industry for which the project is developed.

6.1.2.2 DATA ANALYSIS

A data analysis technique that can be used for this process includes but is not limited to alternatives analysis. Alternatives analysis can include determining which schedule methodology to use, or how to combine various methods on the project. It can also include determining how detailed the schedule needs to be, the duration of waves for rolling wave planning, and how often it should be reviewed and updated. An appropriate balance between the level of detail needed to manage the schedule and the amount of time it takes to keep it up to date needs to be reached for each project.

6.1.2.3 MEETINGS

Project teams may hold planning meetings to develop the schedule management plan. Participants at these meetings may include the project manager, the project sponsor, selected project team members, selected stakeholders, anyone with responsibility for schedule planning or execution, and others as needed.

6.1.3 PLAN SCHEDULE MANAGEMENT: OUTPUTS

6.1.3.1 SCHEDULE MANAGEMENT PLAN

The schedule management plan is a component of the project management plan that establishes the criteria and the activities for developing, monitoring, and controlling the schedule. The schedule management plan may be formal or informal, highly detailed, or broadly framed based on the needs of the project, and includes appropriate control thresholds.

The schedule management plan can establish the following:

- ◆ **Project schedule model development.** The scheduling methodology and the scheduling tool to be used in the development of the project schedule model are specified.
- ◆ **Release and iteration length.** When using an adaptive life cycle, the time-boxed periods for releases, waves, and iterations are specified. Time-boxed periods are durations during which the team works steadily toward completion of a goal. Time-boxing helps to minimize scope creep as it forces the teams to process essential features first, then other features when time permits.
- ◆ **Level of accuracy.** The level of accuracy specifies the acceptable range used in determining realistic activity duration estimates and may include an amount for contingencies.
- ◆ **Units of measure.** Each unit of measurement (such as staff hours, staff days, or weeks for time measures, or meters, liters, tons, kilometers, or cubic yards for quantity measures) is defined for each of the resources.
- ◆ **Organizational procedures links.** The work breakdown structure (WBS) (Section 5.4) provides the framework for the schedule management plan, allowing for consistency with the estimates and resulting schedules.
- ◆ **Project schedule model maintenance.** The process used to update the status and record progress of the project in the schedule model during the execution of the project is defined.
- ◆ **Control thresholds.** Variance thresholds for monitoring schedule performance may be specified to indicate an agreed-upon amount of variation to be allowed before some action needs to be taken. Thresholds are typically expressed as percentage deviations from the parameters established in the baseline plan.
- ◆ **Rules of performance measurement.** Earned value management (EVM) rules or other physical measurement rules of performance measurement are set. For example, the schedule management plan may specify:
 - Rules for establishing percent complete,
 - EVM techniques (e.g., baselines, fixed-formula, percent complete, etc.) to be employed (for more specific information, refer to the *Practice Standard for Earned Value Management* [17]), and
 - Schedule performance measurements such as schedule variance (SV) and schedule performance index (SPI) used to assess the magnitude of variation to the original schedule baseline.
- ◆ **Reporting formats.** The formats and frequency for the various schedule reports are defined.

6.2 DEFINE ACTIVITIES

Define Activities is the process of identifying and documenting the specific actions to be performed to produce the project deliverables. The key benefit of this process is that it decomposes work packages into schedule activities that provide a basis for estimating, scheduling, executing, monitoring, and controlling the project work. This process is performed throughout the project. The inputs, tools and techniques, and outputs of this process are depicted in Figure 6-5. Figure 6-6 depicts the data flow diagram of the process.

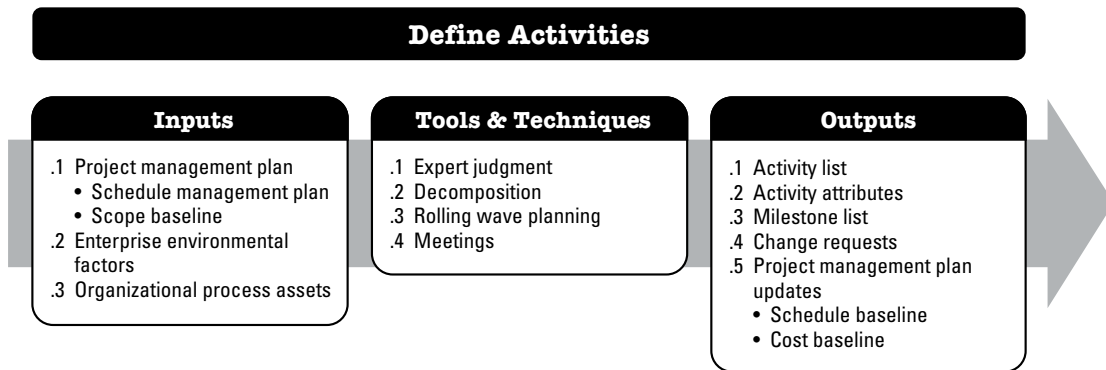

Figure 6-5. Define Activities: Inputs, Tools & Techniques, and Outputs

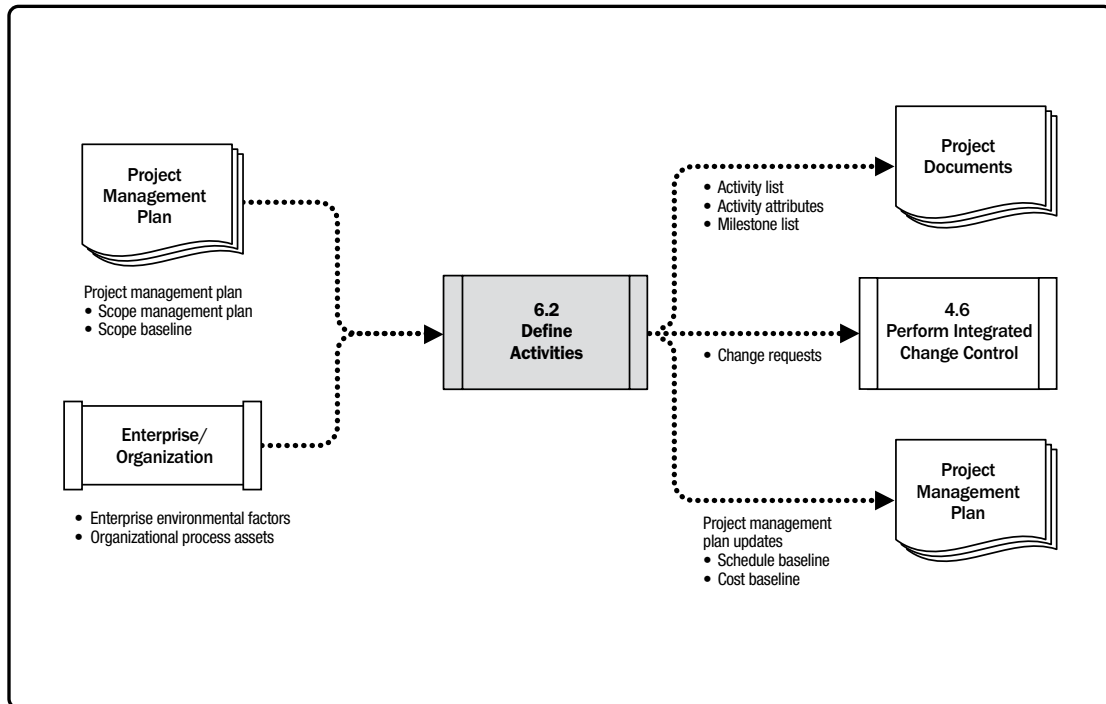

Figure 6-6. Define Activities: Data Flow Diagram

6.2.1 DEFINE ACTIVITIES: INPUTS

6.2.1.1 PROJECT MANAGEMENT PLAN

Described in Section 4.2.3.1. Project management plan components include but are not limited to:

- ◆ **Schedule management plan.** Described in Section 6.1.3.1. The schedule management plan defines the schedule methodology, the duration of waves for rolling wave planning, and the level of detail necessary to manage the work.
- ◆ **Scope baseline.** Described in Section 5.4.3.1. The project WBS, deliverables, constraints, and assumptions documented in the scope baseline are considered explicitly while defining activities.

6.2.1.2 ENTERPRISE ENVIRONMENTAL FACTORS

Enterprise environmental factors that influence the Define Activities process include but are not limited to:

- ◆ Organizational cultures and structure,
- ◆ Published commercial information from commercial databases, and
- ◆ Project management information system (PMIS).

6.2.1.3 ORGANIZATIONAL PROCESS ASSETS

The organizational process assets that can influence the Define Activities process include but are not limited to:

- ◆ Lessons learned repository containing historical information regarding activity lists used by previous similar projects,
- ◆ Standardized processes,
- ◆ Templates that contain a standard activity list or a portion of an activity list from a previous project, and
- ◆ Existing formal and informal activity planning-related policies, procedures, and guidelines, such as the scheduling methodology, that are considered in developing the activity definitions.

6.2.2 DEFINE ACTIVITIES: TOOLS AND TECHNIQUES

6.2.2.1 EXPERT JUDGMENT

Described in Section 4.1.2.1. Expertise should be considered from individuals or groups with specialized knowledge of similar past projects and the work being performed.

6.2.2.2 DECOMPOSITION

Described in Section 5.4.2.2. Decomposition is a technique used for dividing and subdividing the project scope and project deliverables into smaller, more manageable parts. Activities represent the effort needed to complete a work package. The Define Activities process defines the final outputs as activities rather than deliverables, as done in the Create WBS process (Section 5.4).

The activity list, WBS, and WBS dictionary can be developed either sequentially or concurrently, with the WBS and WBS dictionary used as the basis for development of the final activity list. Each work package within the WBS is decomposed into the activities required to produce the work package deliverables. Involving team members in the decomposition can lead to better and more accurate results.

6.2.2.3 ROLLING WAVE PLANNING

Rolling wave planning is an iterative planning technique in which the work to be accomplished in the near term is planned in detail, while work further in the future is planned at a higher level. It is a form of progressive elaboration applicable to work packages, planning packages, and release planning when using an agile or waterfall approach. Therefore, work can exist at various levels of detail depending on where it is in the project life cycle. During early strategic planning when information is less defined, work packages may be decomposed to the known level of detail. As more is known about the upcoming events in the near term, work packages can be decomposed into activities.

6.2.2.4 MEETINGS

Meetings may be face-to-face, virtual, formal, or informal. Meetings may be held with team members or subject matter experts to define the activities needed to complete the work.

6.2.3 DEFINE ACTIVITIES: OUTPUTS

6.2.3.1 ACTIVITY LIST

The activity list includes the schedule activities required on the project. For projects that use rolling wave planning or agile techniques, the activity list will be updated periodically as the project progresses. The activity list includes an activity identifier and a scope of work description for each activity in sufficient detail to ensure that project team members understand what work is required to be completed.

6.2.3.2 ACTIVITY ATTRIBUTES

Activity attributes extend the description of the activity by identifying multiple components associated with each activity. The components for each activity evolve over time. During the initial stages of the project, they include the unique activity identifier (ID), WBS ID, and activity label or name. When completed, they may include activity descriptions, predecessor activities, successor activities, logical relationships, leads and lags (Section 6.3.2.3), resource requirements, imposed dates, constraints, and assumptions. Activity attributes can be used to identify the place where the work has to be performed, the project calendar the activity is assigned to, and the type of effort involved. Activity attributes are used for schedule development and for selecting, ordering, and sorting the planned schedule activities in various ways within reports

6.2.3.3 MILESTONE LIST

A milestone is a significant point or event in a project. A milestone list identifies all project milestones and indicates whether the milestone is mandatory, such as those required by contract, or optional, such as those based on historical information. Milestones have zero duration because they represent a significant point or event.

6.2.3.4 CHANGE REQUESTS

Described in Section 4.3.3.4. Once the project has been baselined, the progressive elaboration of deliverables into activities may reveal work that was not initially part of the project baselines. This may result in a change request. Change requests are processed for review and disposition through the Perform Integrated Change Control process (Section 4.6).

6.2.3.5 PROJECT MANAGEMENT PLAN UPDATES

Any change to the project management plan goes through the organization's change control process via a change request. Components that may require a change request for the project management plan include but are not limited to:

- ◆ **Schedule baseline.** Described in Section 6.5.3.1. Throughout the project, work packages are progressively elaborated into activities. This process may reveal work that was not part of the initial schedule baseline, necessitating a change to delivery dates or other significant schedule milestones that are part of the schedule baseline.
- ◆ **Cost baseline.** Described in Section 7.3.3.1. Changes to the cost baseline are incorporated in response to approved changes in schedule activities.

6.3 SEQUENCE ACTIVITIES

Sequence Activities is the process of identifying and documenting relationships among the project activities. The key benefit of this process is that it defines the logical sequence of work to obtain the greatest efficiency given all project constraints. This process is performed throughout the project. The inputs, tools and techniques, and outputs of this process are depicted in Figure 6-7. Figure 6-8 depicts the data flow diagram of the process.

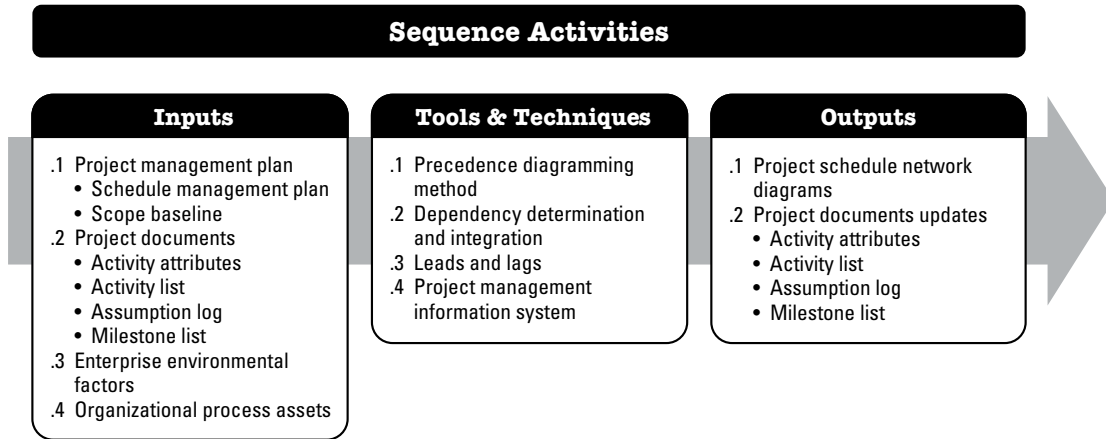

Figure 6-7. Sequence Activities: Inputs, Tools & Techniques, and Outputs

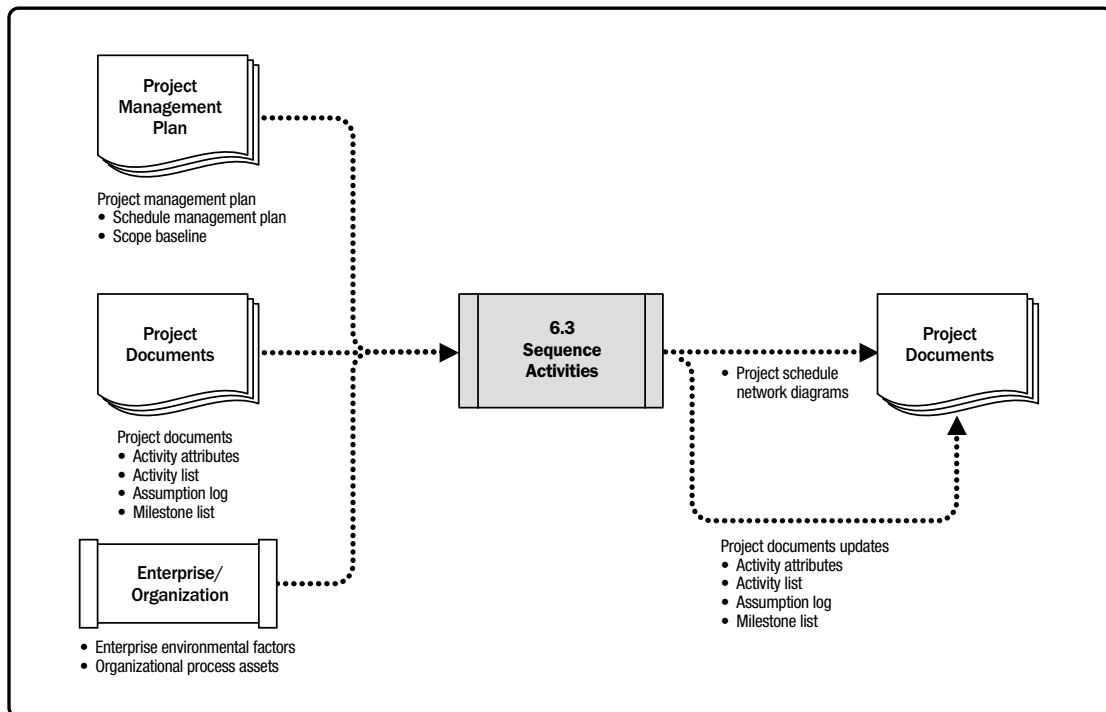

Figure 6-8. Sequence Activities: Data Flow Diagram

Every activity except the first and last should be connected to at least one predecessor and at least one successor activity with an appropriate logical relationship. Logical relationships should be designed to create a realistic project schedule. It may be necessary to use lead or lag time between activities to support a realistic and achievable project schedule. Sequencing can be performed by using project management software or by using manual or automated techniques. The Sequence Activities process concentrates on converting the project activities from a list to a diagram to act as a first step to publish the schedule baseline.

6.3.1 SEQUENCE ACTIVITIES: INPUTS

6.3.1.1 PROJECT MANAGEMENT PLAN

Described in Section 4.2.3.1. Project management plan components include but are not limited to:

- ◆ **Schedule management plan.** Described in Section 6.1.3.1. The schedule management plan defines the method used and the level of accuracy along with other criteria required to sequence activities.
- ◆ **Scope baseline.** Described in Section 5.4.3.1. The project WBS, deliverables, constraints, and assumptions documented in the scope baseline are considered explicitly while sequencing activities.

6.3.1.2 PROJECT DOCUMENTS

Project documents that can be considered as inputs for this process include but are not limited to:

- ◆ **Activity attributes.** Described in Section 6.2.3.2. Activity attributes may describe a necessary sequence of events or defined predecessor or successor relationships, as well as defined lead and lag and logical relationships between the activities.
- ◆ **Activity list.** Described in Section 6.2.3.1. The activity list contains all schedule activities required on the project that are to be sequenced. Dependencies and other constraints for these activities can influence the sequencing of the activities.
- ◆ **Assumption log.** Described in Section 4.1.3.2. Assumptions and constraints recorded in the assumption log may influence the way activities are sequenced, the relationship between activities, and the need for leads and lags, and may give rise to individual project risks that may impact the project schedule.
- ◆ **Milestone list.** Described in Section 6.2.3.3. The milestone list may have scheduled dates for specific milestones, which may influence the way activities are sequenced.

6.3.1.3 ENTERPRISE ENVIRONMENTAL FACTORS

The enterprise environmental factors that can influence the Sequence Activities process include but are not limited to:

- ◆ Government or industry standards,
- ◆ Project management information system (PMIS),
- ◆ Scheduling tools, and
- ◆ Organization work authorization systems.

6.3.1.4 ORGANIZATIONAL PROCESS ASSETS

The organizational process assets that can influence the Sequence Activities process include but are not limited to:

- ◆ Portfolio and program plans and project dependencies and relationships;
- ◆ Existing formal and informal activity planning-related policies, procedures, and guidelines, such as the scheduling methodology that is considered in developing logical relationships;
- ◆ Templates that can be used to expedite the preparation of networks for project activities. Related activity attributes information in templates can also contain additional descriptive information useful in sequencing activities; and
- ◆ Lessons learned repository containing historical information that can help optimize the sequencing process.

6.3.2 SEQUENCE ACTIVITIES: TOOLS AND TECHNIQUES

6.3.2.1 PRECEDENCE DIAGRAMMING METHOD

The precedence diagramming method (PDM) is a technique used for constructing a schedule model in which activities are represented by nodes and are graphically linked by one or more logical relationships to show the sequence in which the activities are to be performed.

PDM includes four types of dependencies or logical relationships. A predecessor activity is an activity that logically comes before a dependent activity in a schedule. A successor activity is a dependent activity that logically comes after another activity in a schedule. These relationships are defined below and are illustrated in Figure 6-9:

- ◆ **Finish-to-start (FS).** A logical relationship in which a successor activity cannot start until a predecessor activity has finished. For example, installing the operating system on a PC (successor) cannot start until the PC hardware is assembled (predecessor).
- ◆ **Finish-to-finish (FF).** A logical relationship in which a successor activity cannot finish until a predecessor activity has finished. For example, writing a document (predecessor) is required to finish before editing the document (successor) can finish.
- ◆ **Start-to-start (SS).** A logical relationship in which a successor activity cannot start until a predecessor activity has started. For example, level concrete (successor) cannot begin until pour foundation (predecessor) begins.
- ◆ **Start-to-finish (SF).** A logical relationship in which a successor activity cannot finish until a predecessor activity has started. For example, a new accounts payable system (successor) has to start before the old accounts payable system can be shut down (predecessor).

In PDM, FS is the most commonly used type of precedence relationship. The SF relationship is very rarely used, but is included to present a complete list of the PDM relationship types.

Two activities can have two logical relationships at the same time (for example, SS and FF). Multiple relationships between the same activities are not recommended, so a decision has to be made to select the relationship with the highest impact. Closed loops are also not recommended in logical relationships.

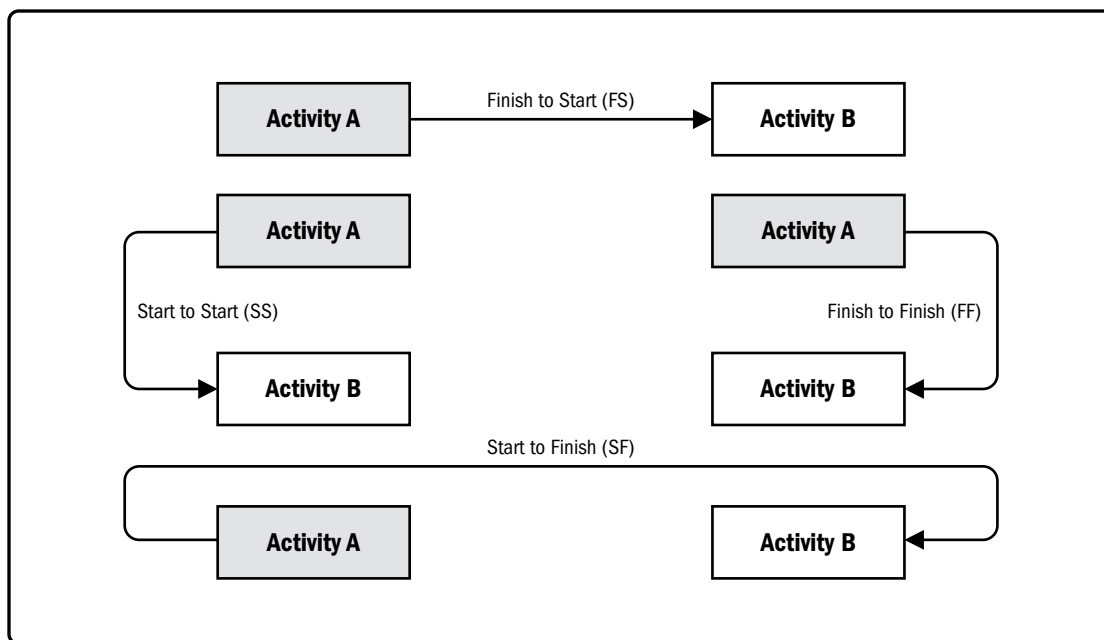

Figure 6-9. Precedence Diagramming Method (PDM) Relationship Types

6.3.2.2 DEPENDENCY DETERMINATION AND INTEGRATION

Dependencies may be characterized by the following attributes: mandatory or discretionary, internal or external (as described below). Dependency has four attributes, but two can be applicable at the same time in the following ways: mandatory external dependencies, mandatory internal dependencies, discretionary external dependencies, or discretionary internal dependencies.

- ◆ **Mandatory dependencies.** Mandatory dependencies are those that are legally or contractually required or inherent in the nature of the work. Mandatory dependencies often involve physical limitations, such as on a construction project, where it is impossible to erect the superstructure until after the foundation has been built, or on an electronics project, where a prototype has to be built before it can be tested. Mandatory dependencies are sometimes referred to as hard logic or hard dependencies. Technical dependencies may not be mandatory. The project team determines which dependencies are mandatory during the process of sequencing the activities. Mandatory dependencies should not be confused with assigning schedule constraints in the scheduling tool.
- ◆ **Discretionary dependencies.** Discretionary dependencies are sometimes referred to as preferred logic, preferential logic, or soft logic. Discretionary dependencies are established based on knowledge of best practices within a particular application area or some unusual aspect of the project where a specific sequence is desired, even though there may be other acceptable sequences. For example, generally accepted best practices recommend that during construction, the electrical work should start after finishing the plumbing work. This order is not mandatory and both activities may occur at the same time (in parallel), but performing the activities in sequential order reduces the overall project risk. Discretionary dependencies should be fully documented since they can create arbitrary total float values and can limit later scheduling options. When fast tracking techniques are employed, these discretionary dependencies should be reviewed and considered for modification or removal. The project team determines which dependencies are discretionary during the process of sequencing the activities.

- ◆ **External dependencies.** External dependencies involve a relationship between project activities and non-project activities. These dependencies are usually outside of the project team’s control. For example, the testing activity in a software project may be dependent on the delivery of hardware from an external source, or governmental environmental hearings may need to be held before site preparation can begin on a construction project. The project management team determines which dependencies are external during the process of sequencing the activities.
- ◆ **Internal dependencies.** Internal dependencies involve a precedence relationship between project activities and are generally inside the project team’s control. For example, if the team cannot test a machine until they assemble it, there is an internal mandatory dependency. The project management team determines which dependencies are internal during the process of sequencing the activities.

6.3.2.3 LEADS AND LAGS

A lead is the amount of time a successor activity can be advanced with respect to a predecessor activity. For example, on a project to construct a new office building, the landscaping could be scheduled to start 2 weeks prior to the scheduled punch list completion. This would be shown as a finish-to-start with a 2-week lead as shown in Figure 6-10. Lead is often represented as a negative value for lag in scheduling software.

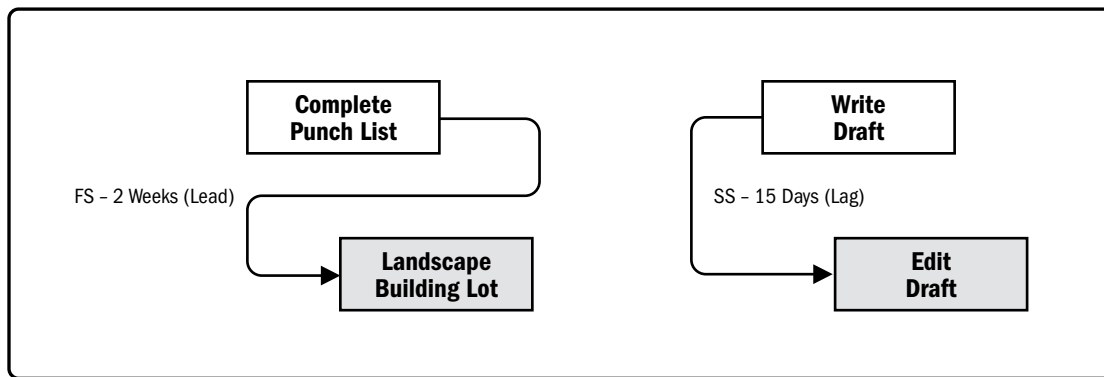

Figure 6-10. Examples of Lead and Lag

A lag is the amount of time a successor activity will be delayed with respect to a predecessor activity. For example, a technical writing team may begin editing the draft of a large document 15 days after they begin writing it. This can be shown as a start-to-start relationship with a 15-day lag as shown in Figure 6-10. Lag can also be represented in project schedule network diagrams as shown in Figure 6-11 in the relationship between activities *H* and *I* (as indicated by the nomenclature SS+10 (start-to-start plus 10 days lag) even though the offset is not shown relative to a timescale).

The project management team determines the dependencies that may require a lead or a lag to accurately define the logical relationship. The use of leads and lags should not replace schedule logic. Also, duration estimates do not include any leads or lags. Activities and their related assumptions should be documented.

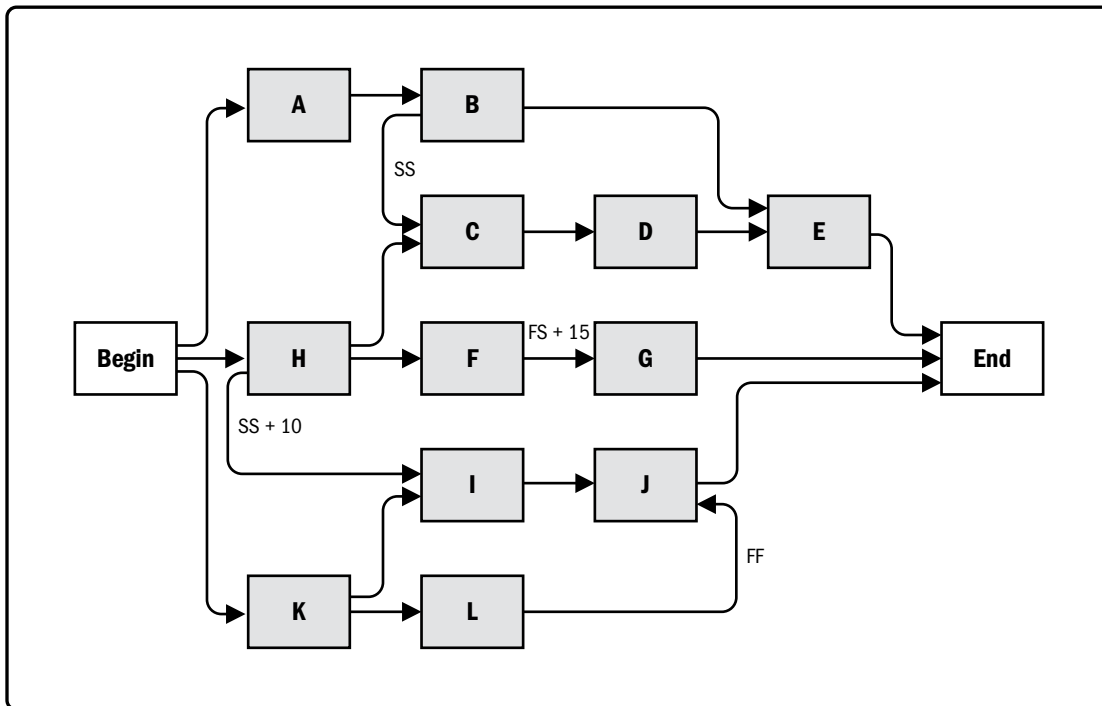

Figure 6-11. Project Schedule Network Diagram

6.3.2.4 PROJECT MANAGEMENT INFORMATION SYSTEM (PMIS)

Described in Section 4.3.2.2. Project management information systems includes scheduling software that has the capability to help plan, organize, and adjust the sequence of the activities; insert the logical relationships, lead and lag values; and differentiate the different types of dependencies.

6.3.3 SEQUENCE ACTIVITIES: OUTPUTS

6.3.3.1 PROJECT SCHEDULE NETWORK DIAGRAMS

A project schedule network diagram is a graphical representation of the logical relationships, also referred to as dependencies, among the project schedule activities. Figure 6-11 illustrates a project schedule network diagram. A project schedule network diagram is produced manually or by using project management software. It can include full project details, or have one or more summary activities. A summary narrative can accompany the diagram and describe the basic approach used to sequence the activities. Any unusual activity sequences within the network should be fully described within the narrative.

Activities that have multiple predecessor activities indicate a path convergence. Activities that have multiple successor activities indicate a path divergence. Activities with divergence and convergence are at greater risk as they are affected by multiple activities or can affect multiple activities. Activity I is called a path convergence, as it has more than one predecessor, while activity K is called a path divergence, as it has more than one successor.

6.3.3.2 PROJECT DOCUMENTS UPDATES

Project documents that may be updated as a result of carrying out this process include but are not limited to:

- ◆ **Activity attributes.** Described in Section 6.2.3.2. Activity attributes may describe a necessary sequence of events or defined predecessor or successor relationships, as well as defined lead and lag and logical relationships between the activities.
- ◆ **Activity list.** Described in Section 6.2.3.1. The activity list may be impacted by the change in relationships among the project activities during the sequencing activities.
- ◆ **Assumption log.** Described in Section 4.1.3.2. Assumptions and constraints recorded in the assumption log may need to be updated based on the sequencing, relationship determination, and leads and lags, and may give rise to individual project risks that may impact the project schedule.
- ◆ **Milestone list.** Described in Section 6.2.3.3. The scheduled dates for specific milestones may be impacted by changes in relationships among the project activities during the sequencing activities.

6.4 ESTIMATE ACTIVITY DURATIONS

Estimate Activity Durations is the process of estimating the number of work periods needed to complete individual activities with estimated resources. The key benefit of this process is that it provides the amount of time each activity will take to complete. This process is performed throughout the project. The inputs, tools and techniques, and outputs of this process are depicted in Figure 6-12. Figure 6-13 depicts the data flow diagram of the process.

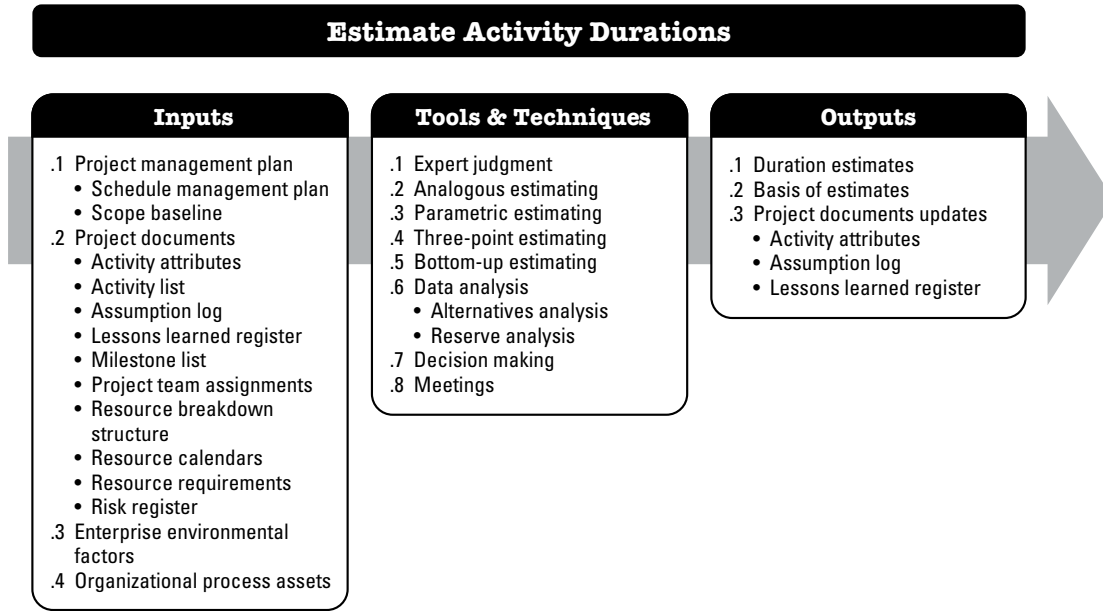

Figure 6-12. Estimate Activity Durations: Inputs, Tools & Techniques, and Outputs

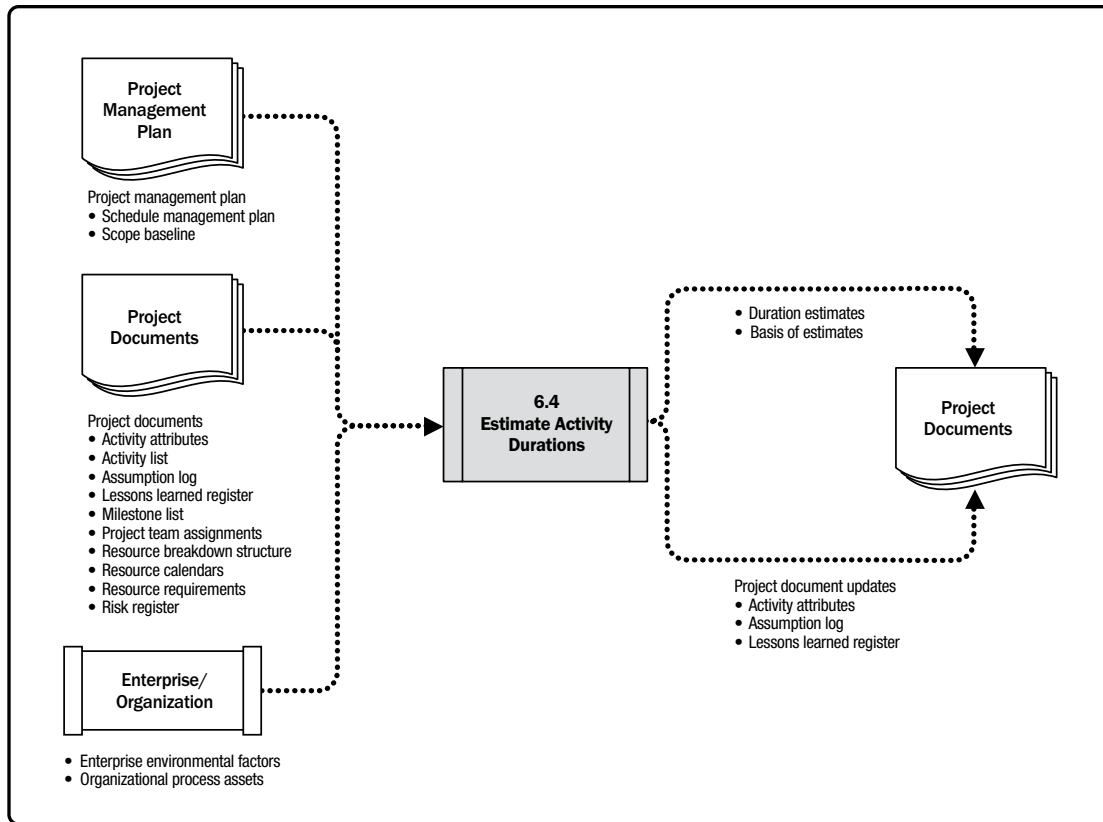

Figure 6-13. Estimate Activity Durations: Data Flow Diagram

Estimating activity durations uses information from the scope of work, required resource types or skill levels, estimated resource quantities, and resource calendars. Other factors that may influence the duration estimates include constraints imposed on the duration, effort involved, or type of resources (e.g., fixed duration, fixed effort or work, fixed number of resources), as well as the schedule network analysis technique used. The inputs for the estimates of duration originate from the person or group on the project team who is most familiar with the nature of the work in the specific activity. The duration estimate is progressively elaborated, and the process considers the quality and availability of the input data. For example, as more detailed and precise data are available about the project engineering and design work, the accuracy and quality of the duration estimates improve.

The Estimate Activity Durations process requires an estimation of the amount of work effort required to complete the activity and the amount of available resources estimated to complete the activity. These estimates are used to approximate the number of work periods (activity duration) needed to complete the activity using the appropriate project and resource calendars. In many cases, the number of resources that are expected to be available to accomplish an activity, along with the skill proficiency of those resources, may determine the activity's duration. A change to a driving resource allocated to the activity will usually have an effect on the duration, but this is not a simple "straight-line" or linear relationship. Sometimes, the intrinsic nature of the work (i.e., constraints imposed on the duration, effort involved, or number of resources) will take a predetermined amount of time to complete regardless of the resource allocation (e.g., a 24-hour stress test). Other factors for consideration when estimating duration include:

- ◆ **Law of diminishing returns.** When one factor (e.g., resource) used to determine the effort required to produce a unit of work is increased while all other factors remain fixed, a point will eventually be reached at which additions of that one factor start to yield progressively smaller or diminishing increases in output.
- ◆ **Number of resources.** Increasing the number of resources to twice the original number of the resources does not always reduce the time by half, as it may increase extra duration due to risk, and at some point adding too many resources to the activity may increase duration due to knowledge transfer, learning curve, additional coordination, and other factors involved.
- ◆ **Advances in technology.** This may also play an important role in determining duration estimates. For example, an increase in the output of a manufacturing plant may be achieved by procuring the latest advances in technology, which may impact duration and resource needs.
- ◆ **Motivation of staff.** The project manager also needs to be aware of Student Syndrome—or procrastination—when people start to apply themselves only at the last possible moment before the deadline, and Parkinson's Law where work expands to fill the time available for its completion.

All data and assumptions that support duration estimating are documented for each activity duration estimate.

6.4.1 ESTIMATE ACTIVITY DURATIONS: INPUTS

6.4.1.1 PROJECT MANAGEMENT PLAN

Described in Section 4.2.3.1. Project management plan components include but are not limited to:

- ◆ **Schedule management plan.** Described in Section 6.1.3.1. The schedule management plan defines the method used, as well as the level of accuracy and other criteria required to estimate activity durations.
- ◆ **Scope baseline.** Described in Section 5.4.3.1. The scope baseline includes the WBS dictionary, which contains technical details that can influence the effort and duration estimates.

6.4.1.2 PROJECT DOCUMENTS

Project documents that can be considered as inputs for this process include but are not limited to:

- ◆ **Activity attributes.** Described in Section 6.2.3.2. Activity attributes may describe defined predecessor or successor relationships, as well as defined lead and lag and logical relationships between the activities that may impact duration estimates.
- ◆ **Activity list.** Described in Section 6.2.3.1. The activity list contains all schedule activities required on the project, which are to be estimated. Dependencies and other constraints for these activities can influence the duration estimates.
- ◆ **Assumption log.** Described in Section 4.1.3.2. Assumptions and constraints recorded in the assumption log may give rise to individual project risks that may impact the project schedule.
- ◆ **Lessons learned register.** Described in Section 4.4.3.1. Lessons learned earlier in the project with regard to effort and duration estimating can be applied to later phases in the project to improve the accuracy and precision of effort and duration estimates.
- ◆ **Milestone list.** Described in Section 6.2.3.3. The milestone list may have scheduled dates for specific milestones that may impact the duration estimates.
- ◆ **Project team assignments.** Described in Section 9.3.3.1. The project is staffed when the appropriate people have been assigned to the team.
- ◆ **Resource breakdown structure.** Described in Section 9.2.3.3. The resource breakdown structure provides a hierarchical structure of the identified resources by resource category and resource type.

- ◆ **Resource calendars.** Described in Section 9.2.1.2. The resource calendars influence the duration of schedule activities due to the availability of specific resources, type of resources, and resources with specific attributes. Resource calendars specify when and how long identified project resources will be available during the project.
- ◆ **Resource requirements.** Described in Section 9.2.3.1. The estimated activity resource requirements will have an effect on the duration of the activity, since the level to which the resources assigned to the activity meet the requirements will significantly influence the duration of most activities. For example, if additional or lower-skilled resources are assigned to an activity, there may be reduced efficiency or productivity due to increased communication, training, and coordination needs leading to a longer duration estimate.
- ◆ **Risk register.** Described in Section 11.2.3.1. Individual project risks may impact resource selection and availability. Updates to the risk register are included with project documents updates, described in Section 11.5.3.2, from Plan Risk Responses.

6.4.1.3 ENTERPRISE ENVIRONMENTAL FACTORS

The enterprise environmental factors that can influence the Estimate Activity Durations process include but are not limited to:

- ◆ Duration estimating databases and other reference data,
- ◆ Productivity metrics,
- ◆ Published commercial information, and
- ◆ Location of team members.

6.4.1.4 ORGANIZATIONAL PROCESS ASSETS

The organizational process assets that can influence the Estimate Activity Durations process include but are not limited to:

- ◆ Historical duration information,
- ◆ Project calendars,
- ◆ Estimating policies,
- ◆ Scheduling methodology, and
- ◆ Lessons learned repository.

6.4.2 ESTIMATE ACTIVITY DURATIONS: TOOLS AND TECHNIQUES

6.4.2.1 EXPERT JUDGMENT

Described in Section 4.1.2.1. Expertise should be considered from individuals or groups with specialized knowledge or training in the following topics:

- ◆ Schedule development, management, and control;
- ◆ Expertise in estimating; and
- ◆ Discipline or application knowledge.

6.4.2.2 ANALOGOUS ESTIMATING

Analogous estimating is a technique for estimating the duration or cost of an activity or a project using historical data from a similar activity or project. Analogous estimating uses parameters from a previous, similar project, such as duration, budget, size, weight, and complexity, as the basis for estimating the same parameter or measure for a future project. When estimating durations, this technique relies on the actual duration of previous, similar projects as the basis for estimating the duration of the current project. It is a gross value estimating approach, sometimes adjusted for known differences in project complexity. Analogous duration estimating is frequently used to estimate project duration when there is a limited amount of detailed information about the project.

Analogous estimating is generally less costly and less time-consuming than other techniques, but it is also less accurate. Analogous duration estimates can be applied to a total project or to segments of a project and may be used in conjunction with other estimating methods. Analogous estimating is most reliable when the previous activities are similar in fact and not just in appearance, and the project team members preparing the estimates have the needed expertise.

6.4.2.3 PARAMETRIC ESTIMATING

Parametric estimating is an estimating technique in which an algorithm is used to calculate cost or duration based on historical data and project parameters. Parametric estimating uses a statistical relationship between historical data and other variables (e.g., square footage in construction) to calculate an estimate for activity parameters, such as cost, budget, and duration.

Durations can be quantitatively determined by multiplying the quantity of work to be performed by the number of labor hours per unit of work. For example, duration on a design project is estimated by the number of drawings multiplied by the number of labor hours per drawing, or on a cable installation, the meters of cable multiplied by the number of labor hours per meter. If the assigned resource is capable of installing 25 meters of cable per hour, the duration required to install 1,000 meters is 40 hours (1,000 meters divided by 25 meters per hour).

This technique can produce higher levels of accuracy depending on the sophistication and underlying data built into the model. Parametric schedule estimates can be applied to a total project or to segments of a project, in conjunction with other estimating methods.

6.4.2.4 THREE-POINT ESTIMATING

The accuracy of single-point duration estimates may be improved by considering estimation uncertainty and risk. Using three-point estimates helps define an approximate range for an activity's duration:

- ◆ **Most likely (*tM*)**. This estimate is based on the duration of the activity, given the resources likely to be assigned, their productivity, realistic expectations of availability for the activity, dependencies on other participants, and interruptions.
- ◆ **Optimistic (*tO*)**. The activity duration based on analysis of the best-case scenario for the activity.
- ◆ **Pessimistic (*tP*)**. The duration based on analysis of the worst-case scenario for the activity.

Depending on the assumed distribution of values within the range of the three estimates, the expected duration, *tE*, can be calculated. One commonly used formula is triangular distribution:

$$tE = (tO + tM + tP) / 3.$$

Triangular distribution is used when there is insufficient historical data or when using judgmental data. Duration estimates based on three points with an assumed distribution provide an expected duration and clarify the range of uncertainty around the expected duration.

6.4.2.5 BOTTOM-UP ESTIMATING

Bottom-up estimating is a method of estimating project duration or cost by aggregating the estimates of the lower-level components of the WBS. When an activity's duration cannot be estimated with a reasonable degree of confidence, the work within the activity is decomposed into more detail. The detail durations are estimated. These estimates are then aggregated into a total quantity for each of the activity's durations. Activities may or may not have dependencies between them that can affect the application and use of resources. If there are dependencies, this pattern of resource usage is reflected and documented in the estimated requirements of the activity.

6.4.2.6 DATA ANALYSIS

Data analysis techniques that can be used for this process include but are not limited to:

- ◆ **Alternatives analysis.** Alternatives analysis is used to compare various levels of resource capability or skills; scheduling compression techniques (described in Section 6.5.2.6); different tools (manual versus automated); and make, rent, or buy decisions regarding the resources. This allows the team to weigh resource, cost, and duration variables to determine an optimal approach for accomplishing project work.
- ◆ **Reserve analysis.** Reserve analysis is used to determine the amount of contingency and management reserve needed for the project. Duration estimates may include contingency reserves, sometimes referred to as schedule reserves, to account for schedule uncertainty. Contingency reserves are the estimated duration within the schedule baseline, which is allocated for identified risks that are accepted. Contingency reserves are associated with the known-unknowns, which may be estimated to account for this unknown amount of rework. The contingency reserve may be a percentage of the estimated activity duration or a fixed number of work periods. Contingency reserves may be separated from the individual activities and aggregated. As more precise information about the project becomes available, the contingency reserve may be used, reduced, or eliminated. Contingency should be clearly identified in the schedule documentation.

Estimates may also be produced for the amount of management reserve of schedule for the project. Management reserves are a specified amount of the project budget withheld for management control purposes and are reserved for unforeseen work that is within scope of the project. Management reserves are intended to address the unknown-unknowns that can affect a project. Management reserve is not included in the schedule baseline, but it is part of the overall project duration requirements. Depending on contract terms, use of management reserves may require a change to the schedule baseline.

6.4.2.7 DECISION MAKING

Described in Section 5.2.2.4. Decision-making techniques that can be used in this process include but are not limited to voting. One variation of the voting method that is often used in agile-based projects is called the fist of five (also called fist to five). In this technique, the project manager asks the team to show their level of support for a decision by holding up a closed fist (indicating no support) up to five fingers (indicating full support). If a team member holds up fewer than three fingers, the team member is given the opportunity to discuss any objections with the team. The project manager continues the fist-of-five process until the team achieves consensus (everyone holds up three or more fingers) or agrees to move on to the next decision.

6.4.2.8 MEETINGS

The project team may hold meetings to estimate activity durations. When using an agile approach, it is necessary to conduct sprint or iteration planning meetings to discuss prioritized product backlog items (user stories) and decide which of these items the team will commit to work on in the upcoming iteration. The team breaks down user stories to low-level tasks, with estimates in hours, and then validates that the estimates are achievable based on team capacity over the duration (iteration). This meeting is usually held on the first day of the iteration and is attended by the product owner, the Scrum team, and the project manager. The outcome of the meeting includes an iteration backlog, as well as assumptions, concerns, risks, dependencies, decisions, and actions.

6.4.3 ESTIMATE ACTIVITY DURATIONS: OUTPUTS

6.4.3.1 DURATION ESTIMATES

Duration estimates are quantitative assessments of the likely number of time periods that are required to complete an activity, a phase, or a project. Duration estimates do not include any lags as described in Section 6.3.2.3. Duration estimates may include some indication of the range of possible results. For example:

- ◆ A range of 2 weeks \pm 2 days, which indicates that the activity will take at least 8 days and not more than 12 (assuming a 5-day work week); or
- ◆ A 15% probability of exceeding 3 weeks, which indicates a high probability—85%—that the activity will take 3 weeks or less.

6.4.3.2 BASIS OF ESTIMATES

The amount and type of additional details supporting the duration estimate vary by application area. Regardless of the level of detail, the supporting documentation should provide a clear and complete understanding of how the duration estimate was derived.

Supporting detail for duration estimates may include:

- ◆ Documentation of the basis of the estimate (i.e., how it was developed),
- ◆ Documentation of all assumptions made,
- ◆ Documentation of any known constraints,
- ◆ Indication of the range of possible estimates (e.g., $\pm 10\%$) to indicate that the duration is estimated between a range of values),
- ◆ Indication of the confidence level of the final estimate, and
- ◆ Documentation of individual project risks influencing this estimate.

6.4.3.3 PROJECT DOCUMENTS UPDATES

Project documents that may be updated as a result of carrying out this process include but are not limited to:

- ◆ **Activity attributes.** Described in Section 6.2.3.2. Activity duration estimates produced during this process are documented as part of the activity attributes.
- ◆ **Assumption log.** Described in Section 4.1.3.2. This includes assumptions made in developing the duration estimate, such as resource skill levels and availability, as well as a basis of estimates for durations. Additionally, constraints arising out of the scheduling methodology and scheduling tool are also documented.
- ◆ **Lessons learned register.** Described in Section 4.4.3.1. The lessons learned register can be updated with techniques that were efficient and effective in developing effort and duration estimates.

6.5 DEVELOP SCHEDULE

Develop Schedule is the process of analyzing activity sequences, durations, resource requirements, and schedule constraints to create a schedule model for project execution and monitoring and controlling. The key benefit of this process is that it generates a schedule model with planned dates for completing project activities. This process is performed throughout the project. The inputs, tools and techniques, and outputs of this process are depicted in Figure 6-14. Figure 6-15 depicts the data flow diagram of the process.

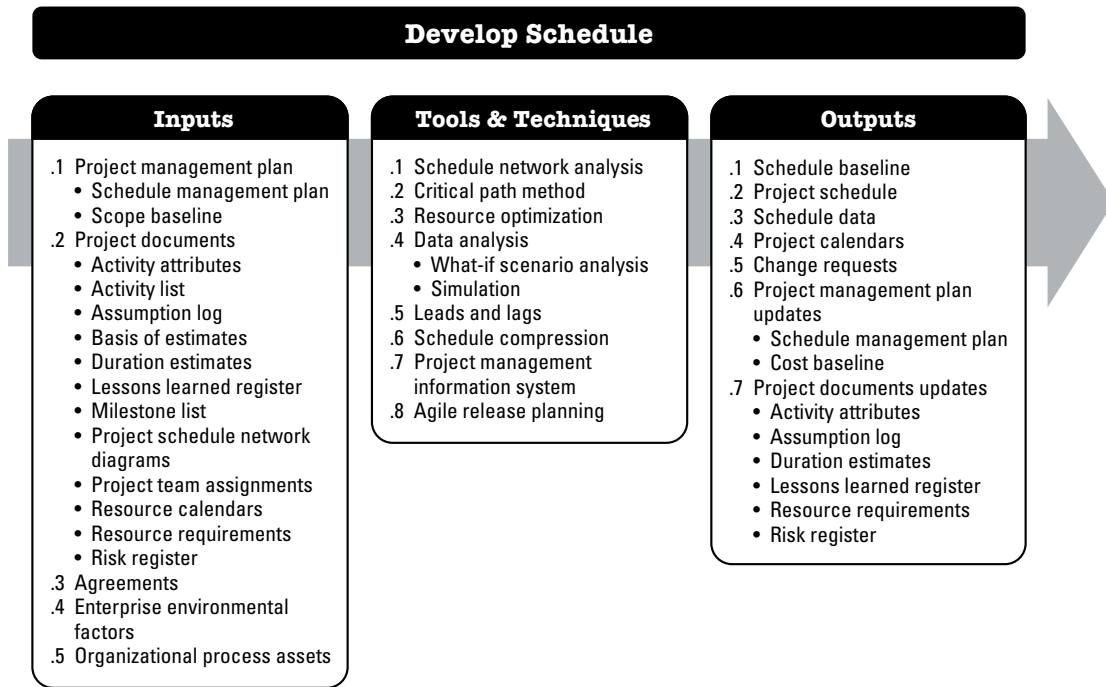

Figure 6-14. Develop Schedule: Inputs, Tools & Techniques, and Outputs

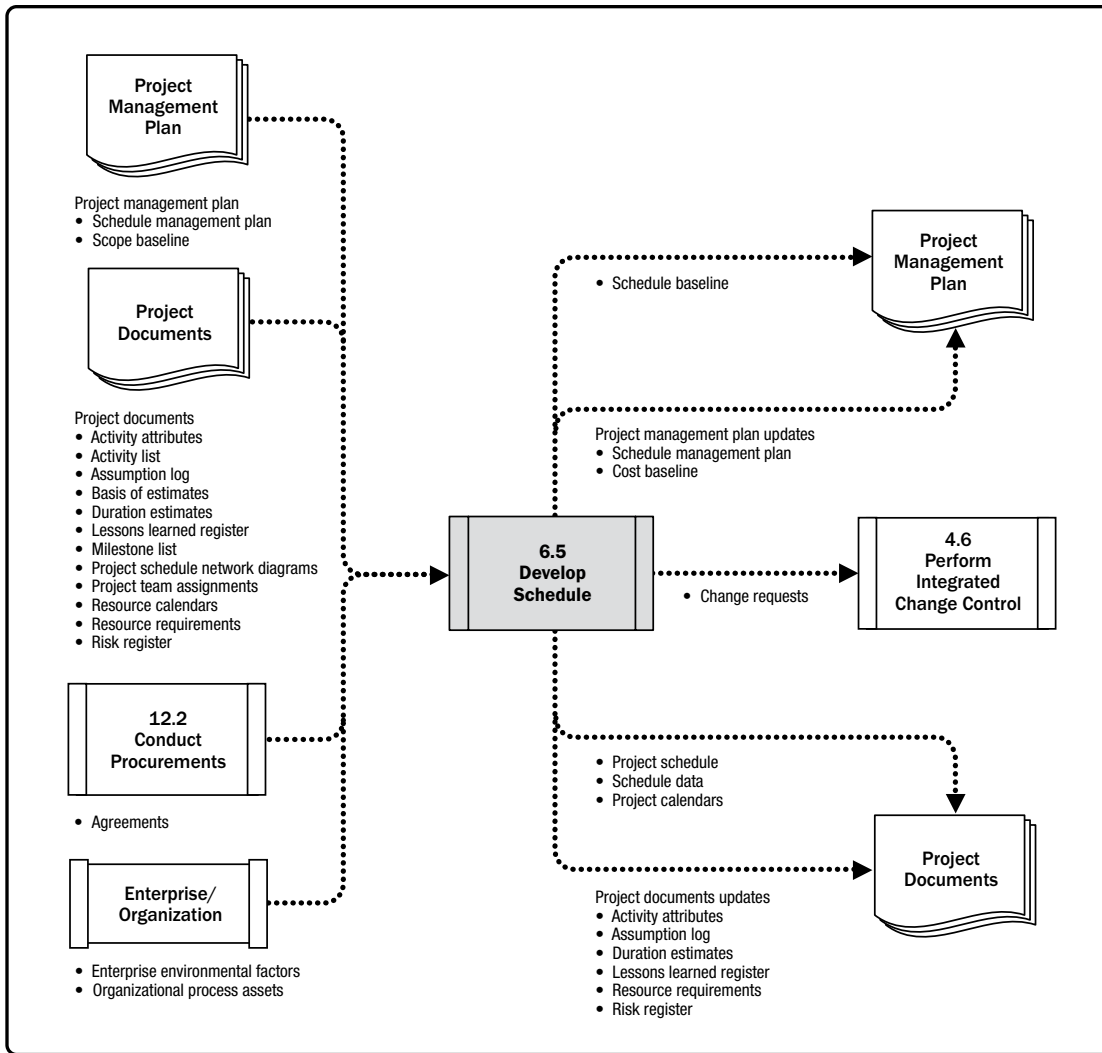

Figure 6-15. Develop Schedule: Data Flow Diagram

Developing an acceptable project schedule is an iterative process. The schedule model is used to determine the planned start and finish dates for project activities and milestones based on the best available information. Schedule development can require the review and revision of duration estimates, resource estimates, and schedule reserves to establish an approved project schedule that can serve as a baseline to track progress. Key steps include defining the project milestones, identifying and sequencing activities, and estimating durations. Once the activity start and finish dates have been determined, it is common to have the project staff assigned to the activities review their assigned activities. The staff confirms that the start and finish dates present no conflict with resource calendars or assigned activities on other projects or tasks and thus are still valid. The schedule is then analyzed to determine conflicts with logical relationships and if resource leveling is required before the schedule is approved and baselined. Revising and maintaining the project schedule model to sustain a realistic schedule continues throughout the duration of the project, as described in Section 6.7.

For more specific information regarding scheduling, refer to the *Practice Standard for Scheduling*.

6.5.1 DEVELOP SCHEDULE: INPUTS

6.5.1.1 PROJECT MANAGEMENT PLAN

Described in Section 4.2.3.1. Project management plan components include but are not limited to:

- ◆ **Schedule management plan.** Described in Section 6.1.3.1. The schedule management plan identifies the scheduling method and tool used to create the schedule and how the schedule is to be calculated.
- ◆ **Scope baseline.** Described in Section 5.4.3.1. The scope statement, WBS, and WBS dictionary have details about the project deliverables that are considered when building the schedule model.

6.5.1.2 PROJECT DOCUMENTS

Project documents that can be considered as inputs for this process include but are not limited to:

- ◆ **Activity attributes.** Described in Section 6.2.3.2. The activity attributes provide the details used to build the schedule model.
- ◆ **Activity list.** Described in Section 6.2.3.1. The activity list identifies the activities that will be included in the schedule model.
- ◆ **Assumption log.** Described in Section 4.1.3.2. Assumptions and constraints recorded in the assumption log may give rise to individual project risks that may impact the project schedule.

- ◆ **Basis of estimates.** Described in Section 6.4.3.2. The amount and type of additional details supporting the duration estimate vary by application area. Regardless of the level of detail, the supporting documentation should provide a clear and complete understanding of how the duration estimate was derived.
- ◆ **Duration estimates.** Described in Section 6.4.3.1. The duration estimates contain the quantitative assessments of the likely number of work periods that will be required to complete an activity. This will be used to calculate the schedule.
- ◆ **Lessons learned.** Described in Section 4.4.3.1. Lessons learned earlier in the project with regard to developing the schedule model can be applied to later phases in the project to improve the validity of the schedule model.
- ◆ **Milestone list.** Described in Section 6.2.3.3. The milestone list has scheduled dates for specific milestones.
- ◆ **Project schedule network diagrams.** Described in Section 6.3.3.1. The project schedule network diagrams contain the logical relationships of predecessors and successors that will be used to calculate the schedule.
- ◆ **Project team assignments.** Described in Section 9.3.3.1. The project team assignments specify which resources are assigned to each activity.
- ◆ **Resource calendars.** Described in Sections 9.2.1.2. The resource calendars contain information on the availability of resources during the project.
- ◆ **Resource requirements.** Described in Section 9.2.3.1. The activity resource requirements identify the types and quantities of resources required for each activity used to create the schedule model.
- ◆ **Risk register.** Described in Section 11.2.3.1. The risk register provides the details of all identified risks, and their characteristics, that affect the schedule model. Risk information relevant to the schedule is reflected in schedule reserves using the expected or mean risk impact.

6.5.1.3 AGREEMENTS

Described in Section 12.2.3.2. Vendors may have an input to the project schedule as they develop the details of how they will perform the project work to meet contractual commitments.

6.5.1.4 ENTERPRISE ENVIRONMENTAL FACTORS

The enterprise environmental factors that can influence the Develop Schedule process include but are not limited to:

- ◆ Government or industry standards, and
- ◆ Communication channels.

6.5.1.5 ORGANIZATIONAL PROCESS ASSETS

The organizational process assets that can influence the Develop Schedule process include but are not limited to:

- ◆ Scheduling methodology containing the policies governing schedule model development and maintenance, and
- ◆ Project calendar(s).

6.5.2 DEVELOP SCHEDULE: TOOLS AND TECHNIQUES

6.5.2.1 SCHEDULE NETWORK ANALYSIS

Schedule network analysis is the overarching technique used to generate the project schedule model. It employs several other techniques such as critical path method (described in Section 6.5.2.2), resource optimization techniques (described in Section 6.5.2.3), and modeling techniques (described in Section 6.5.2.4). Additional analysis includes but is not limited to:

- ◆ Assessing the need to aggregate schedule reserves to reduce the probability of a schedule slip when multiple paths converge at a single point in time or when multiple paths diverge from a single point in time, to reduce the probability of a schedule slip.
- ◆ Reviewing the network to see if the critical path has high-risk activities or long lead items that would necessitate use of schedule reserves or the implementation of risk responses to reduce the risk on the critical path.

Schedule network analysis is an iterative process that is employed until a viable schedule model is developed.

6.5.2.2 CRITICAL PATH METHOD

The critical path method is used to estimate the minimum project duration and determine the amount of schedule flexibility on the logical network paths within the schedule model. This schedule network analysis technique calculates the early start, early finish, late start, and late finish dates for all activities without regard for any resource limitations by performing a forward and backward pass analysis through the schedule network, as shown in Figure 6-16. In this example, the longest path includes activities A, C, and D, and therefore the sequence of A-C-D is the critical path. The critical path is the sequence of activities that represents the longest path through a project, which determines the shortest possible project duration. The longest path has the least total float—usually zero. The resulting early and late start and finish dates are not necessarily the project schedule; rather they indicate the time periods within which the activity could be executed, using the parameters entered in the schedule model for activity durations, logical relationships, leads, lags, and other known constraints. The critical path method is used to calculate the critical path(s) and the amount of total and free float or schedule flexibility on the logical network paths within the schedule model.

On any network path, the total float or schedule flexibility is measured by the amount of time that a schedule activity can be delayed or extended from its early start date without delaying the project finish date or violating a schedule constraint. A critical path is normally characterized by zero total float on the critical path. As implemented with the precedence diagramming method sequencing, critical paths may have positive, zero, or negative total float depending on the constraints applied. Positive total float is caused when the backward pass is calculated from a schedule constraint that is later than the early finish date that has been calculated during forward pass calculation. Negative total float is caused when a constraint on the late dates is violated by duration and logic. Negative float analysis is a technique that helps to find possible accelerated ways of bringing a delayed schedule back on track. Schedule networks may have multiple near-critical paths. Many software packages allow the user to define the parameters used to determine the critical path(s). Adjustments to activity durations (when more resources or less scope can be arranged), logical relationships (when the relationships were discretionary to begin with), leads and lags, or other schedule constraints may be necessary to produce network paths with a zero or positive total float. Once the total float and the free float have been calculated, the free float is the amount of time that a schedule activity can be delayed without delaying the early start date of any successor or violating a schedule constraint. For example the free float for Activity B, in Figure 6-16, is 5 days.



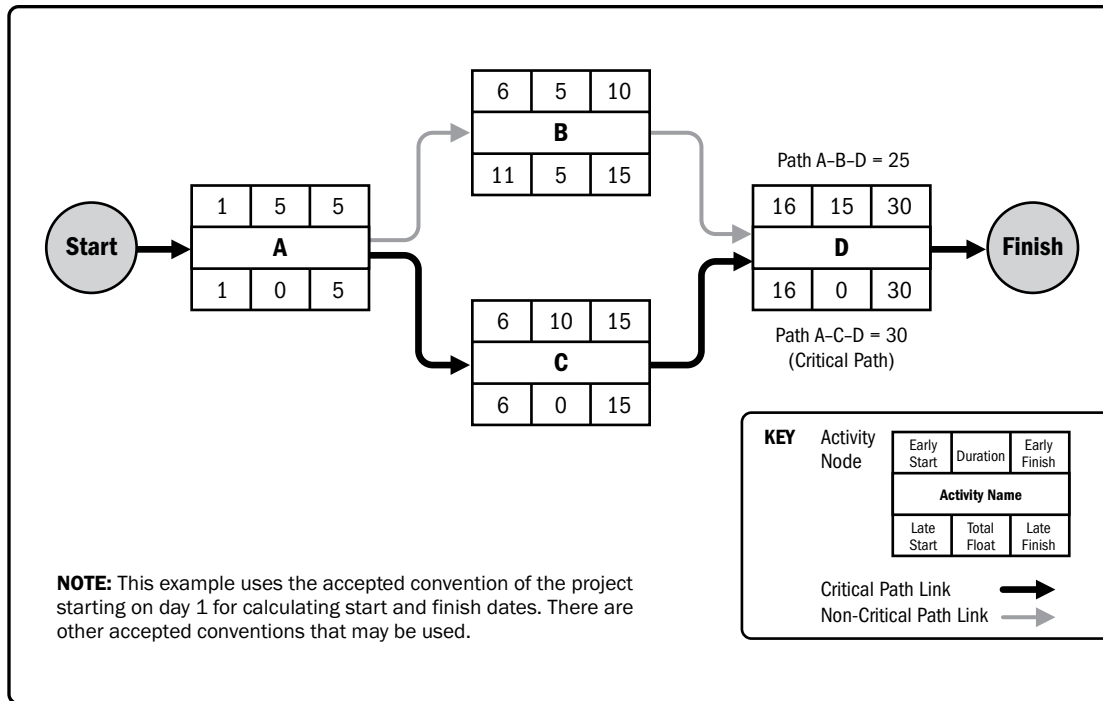

Figure 6-16. Example of Critical Path Method

6.5.2.3 RESOURCE OPTIMIZATION

Resource optimization is used to adjust the start and finish dates of activities to adjust planned resource use to be equal to or less than resource availability. Examples of resource optimization techniques that can be used to adjust the schedule model due to demand and supply of resources include but are not limited to:

- ◆ **Resource leveling.** A technique in which start and finish dates are adjusted based on resource constraints with the goal of balancing the demand for resources with the available supply. Resource leveling can be used when shared or critically required resources are available only at certain times or in limited quantities, or are over-allocated, such as when a resource has been assigned to two or more activities during the same time period (as shown in Figure 6-17), or there is a need to keep resource usage at a constant level. Resource leveling can often cause the original critical path to change. Available float is used for leveling resources. Consequently, the critical path through the project schedule may change.
- ◆ **Resource smoothing.** A technique that adjusts the activities of a schedule model such that the requirements for resources on the project do not exceed certain predefined resource limits. In resource smoothing, as opposed to resource leveling, the project's critical path is not changed and the completion date may not be delayed. In other words, activities may only be delayed within their free and total float. Resource smoothing may not be able to optimize all resources.

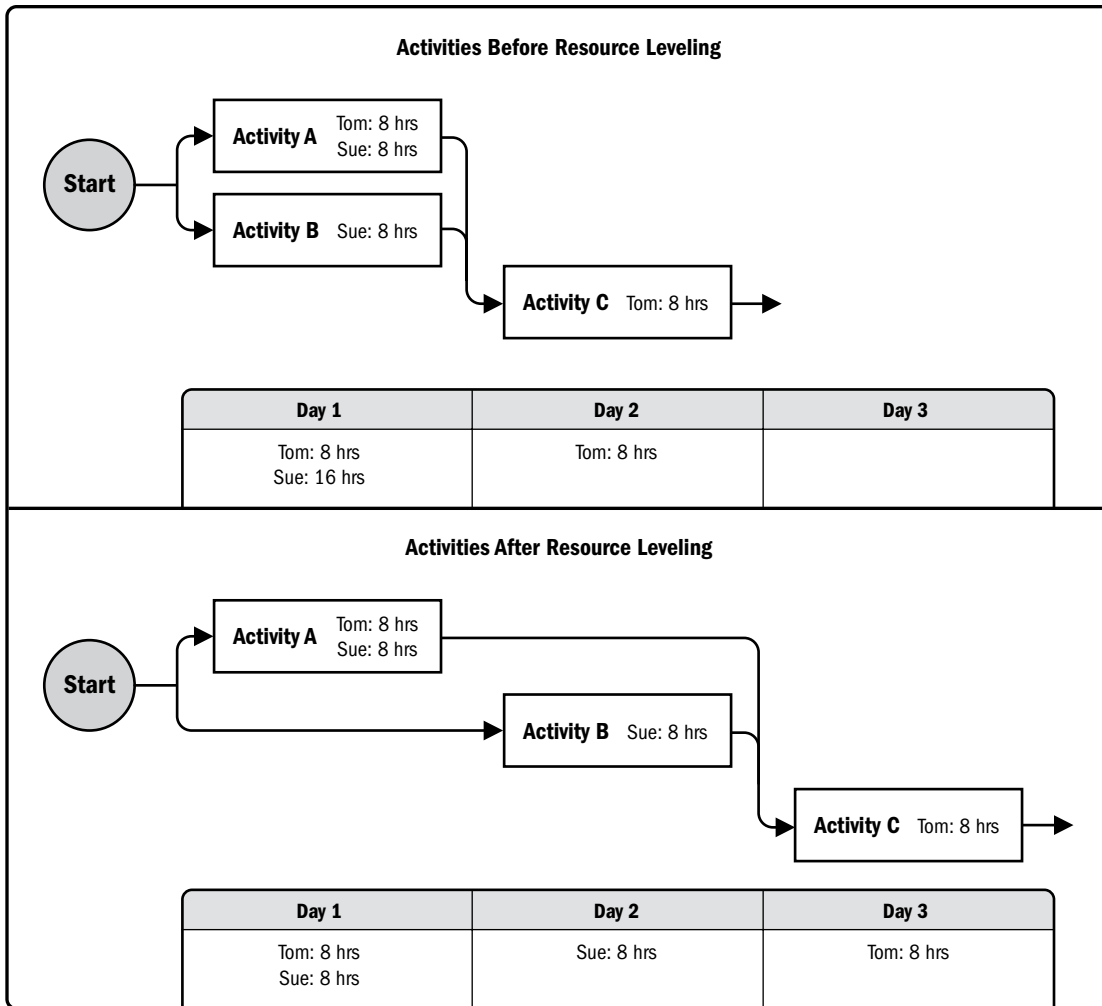

Figure 6-17. Resource Leveling

6.5.2.4 DATA ANALYSIS

Data analysis techniques that can be used for this process include but are not limited to:

- ◆ **What-if scenario analysis.** What-if scenario analysis is the process of evaluating scenarios in order to predict their effect, positive or negative, on project objectives. This is an analysis of the question, “What if the situation represented by scenario X happens?” A schedule network analysis is performed using the schedule to compute the different scenarios, such as delaying a major component delivery, extending specific engineering durations, or introducing external factors, such as a strike or a change in the permit process. The outcome of the what-if scenario analysis can be used to assess the feasibility of the project schedule under different conditions, and in preparing schedule reserves and response plans to address the impact of unexpected situations.
- ◆ **Simulation.** Simulation models the combined effects of individual project risks and other sources of uncertainty to evaluate their potential impact on achieving project objectives. The most common simulation technique is Monte Carlo analysis (see Section 11.4.2.5), in which risks and other sources of uncertainty are used to calculate possible schedule outcomes for the total project. Simulation involves calculating multiple work package durations with different sets of activity assumptions, constraints, risks, issues, or scenarios using probability distributions and other representations of uncertainty (see Section 11.4.2.4). Figure 6-18 shows a probability distribution for a project with the probability of achieving a certain target date (i.e., project finish date). In this example, there is a 10% probability that the project will finish on or before the target date of May 13, while there is a 90% probability of completing the project by May 28.

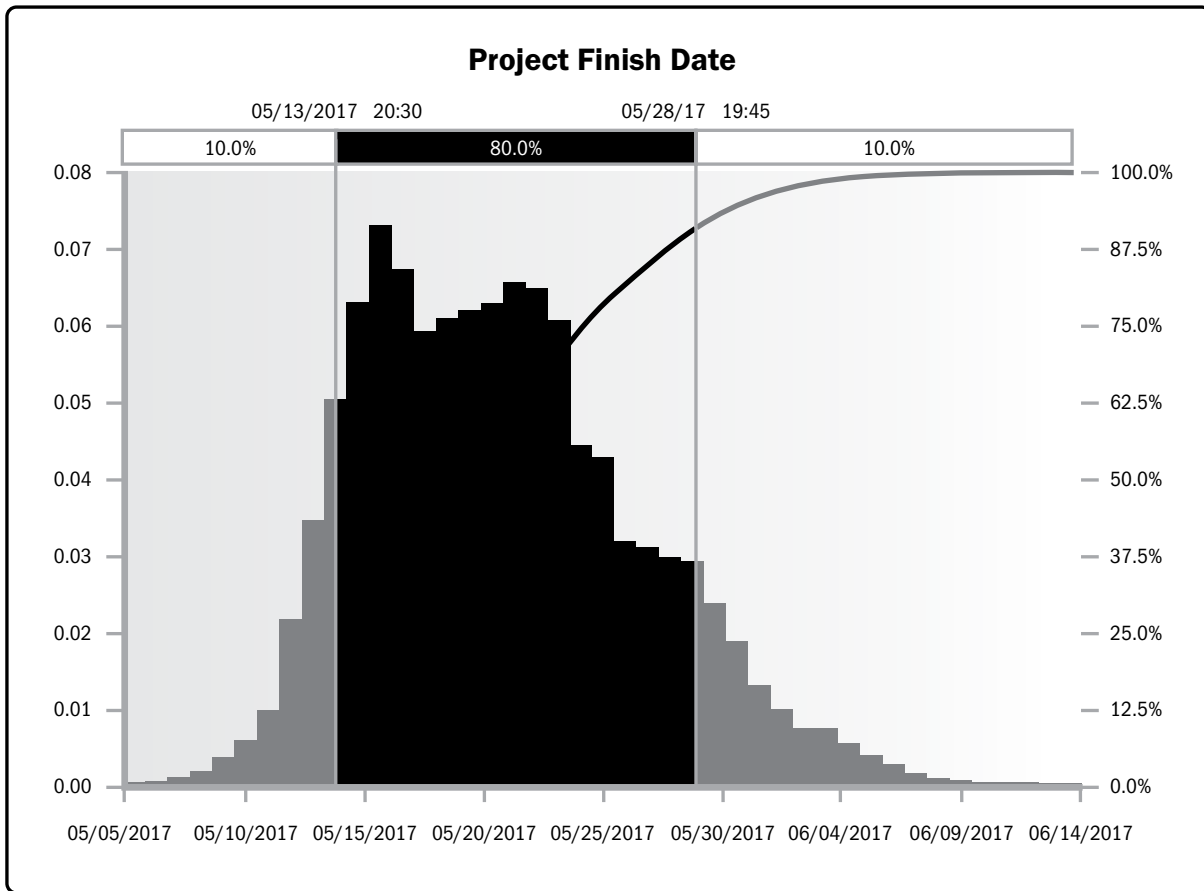

Figure 6-18. Example Probability Distribution of a Target Milestone

For more information on how Monte Carlo simulation is used for schedule models, see the *Practice Standard for Scheduling*.

6.5.2.5 LEADS AND LAGS

Described in Section 6.3.2.3. Leads and lags are refinements applied during network analysis to develop a viable schedule by adjusting the start time of the successor activities. Leads are used in limited circumstances to advance a successor activity with respect to the predecessor activity, and lags are used in limited circumstances where processes require a set period of time to elapse between the predecessors and successors without work or resource impact.

6.5.2.6 SCHEDULE COMPRESSION

Schedule compression techniques are used to shorten or accelerate the schedule duration without reducing the project scope in order to meet schedule constraints, imposed dates, or other schedule objectives. A helpful technique is the negative float analysis. The critical path is the one with the least float. Due to violating a constraint or imposed date, the total float can become negative. Schedule compression techniques are compared in Figure 6-19 and include:

- ◆ **Crashing.** A technique used to shorten the schedule duration for the least incremental cost by adding resources. Examples of crashing include approving overtime, bringing in additional resources, or paying to expedite delivery to activities on the critical path. Crashing works only for activities on the critical path where additional resources will shorten the activity's duration. Crashing does not always produce a viable alternative and may result in increased risk and/or cost.
- ◆ **Fast tracking.** A schedule compression technique in which activities or phases normally done in sequence are performed in parallel for at least a portion of their duration. An example is constructing the foundation for a building before completing all of the architectural drawings. Fast tracking may result in rework and increased risk. Fast tracking only works when activities can be overlapped to shorten the project duration on the critical path. Using leads in case of schedule acceleration usually increases coordination efforts between the activities concerned and increases quality risk. Fast tracking may also increase project costs.

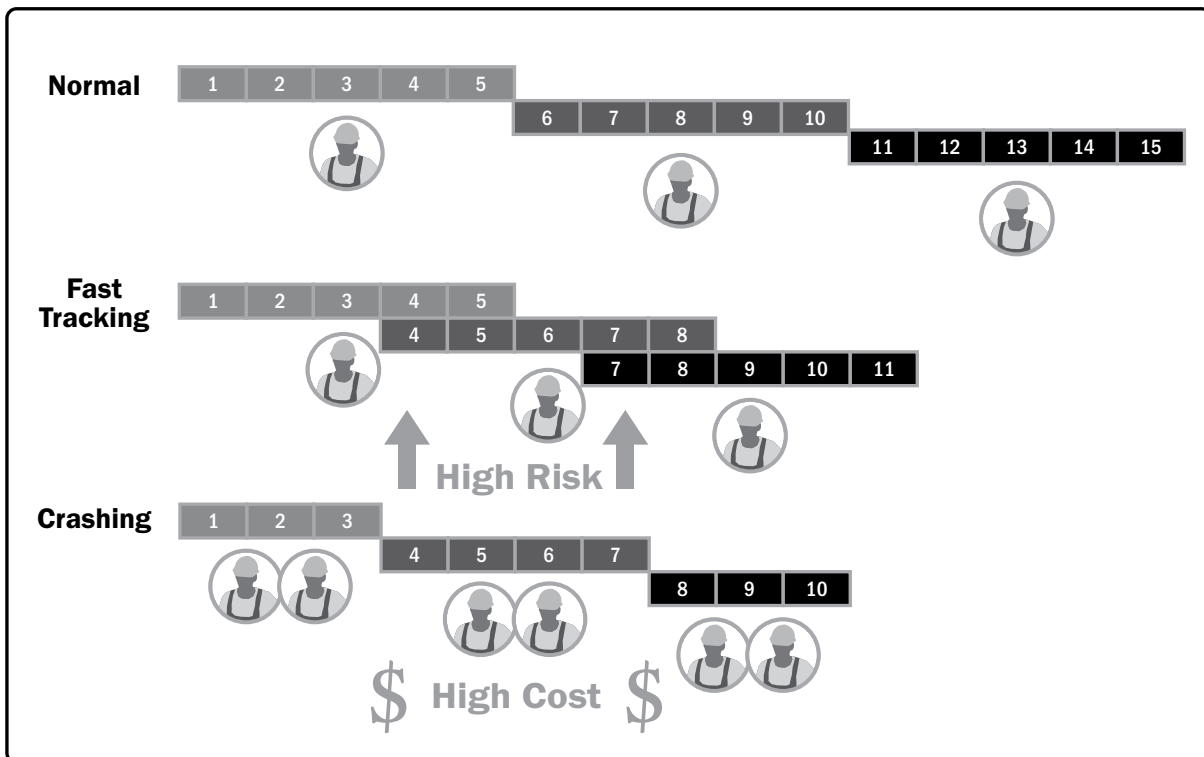

Figure 6-19. Schedule Compression Comparison

6.5.2.7 PROJECT MANAGEMENT INFORMATION SYSTEM (PMIS)

Described in Section 4.3.2.2. Project management information systems include scheduling software that expedites the process of building a schedule model by generating start and finish dates based on the inputs of activities, network diagrams, resources, and activity durations.

6.5.2.8 AGILE RELEASE PLANNING

Agile release planning provides a high-level summary timeline of the release schedule (typically 3 to 6 months) based on the product roadmap and the product vision for the product's evolution. Agile release planning also determines the number of iterations or sprints in the release, and allows the product owner and team to decide how much needs to be developed and how long it will take to have a releasable product based on business goals, dependencies, and impediments.

Since features represent value to the customer, the timeline provides a more easily understood project schedule as it defines which feature will be available at the end of each iteration, which is exactly the depth of information the customer is looking for.

Figure 6-20 shows the relationship among product vision, product roadmap, release planning, and iteration planning.

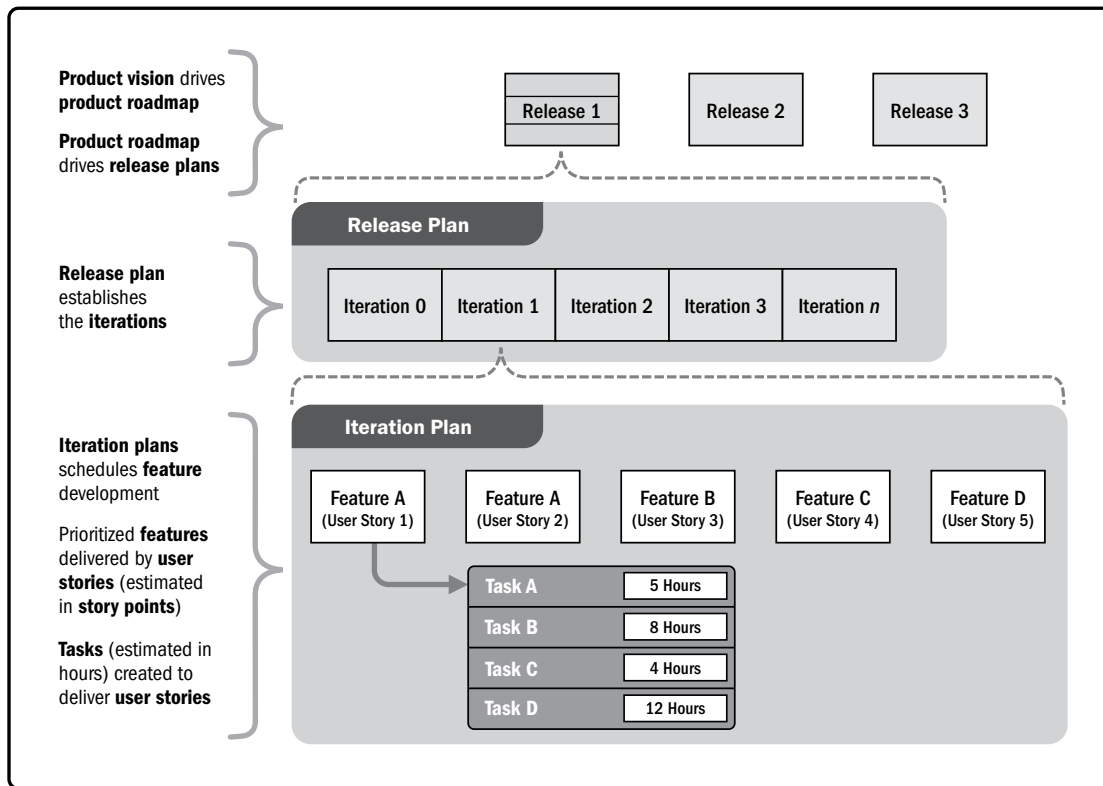

Figure 6-20. Relationship Between Product Vision, Release Planning, and Iteration Planning

6.5.3 DEVELOP SCHEDULE: OUTPUTS

6.5.3.1 SCHEDULE BASELINE

A schedule baseline is the approved version of a schedule model that can be changed only through formal change control procedures and is used as a basis for comparison to actual results. It is accepted and approved by the appropriate stakeholders as the schedule baseline with baseline start dates and baseline finish dates. During monitoring and controlling, the approved baseline dates are compared to the actual start and finish dates to determine if variances have occurred. The schedule baseline is a component of the project management plan.

6.5.3.2 PROJECT SCHEDULE

The project schedule is an output of a schedule model that presents linked activities with planned dates, durations, milestones, and resources. At a minimum, the project schedule includes a planned start date and planned finish date for each activity. If resource planning is done at an early stage, the project schedule remains preliminary until resource assignments have been confirmed and scheduled start and finish dates are established. This process usually occurs no later than the completion of the project management plan (Section 4.2.3.1). A target project schedule model may also be developed with a defined target start and target finish for each activity. The project schedule may be presented in summary form, sometimes referred to as the master schedule or milestone schedule, or presented in detail. Although a project schedule model can be presented in tabular form, it is more often presented graphically, using one or more of the following formats:

- ◆ **Bar charts.** Also known as Gantt charts, bar charts represent schedule information where activities are listed on the vertical axis, dates are shown on the horizontal axis, and activity durations are shown as horizontal bars placed according to start and finish dates. Bar charts are relatively easy to read and are commonly used. Depending on the audience, float can be depicted or not. For control and management communications, the broader, more comprehensive summary activity is used between milestones or across multiple interdependent work packages and is displayed in bar chart reports. An example is the summary schedule portion of Figure 6-21 that is presented in a WBS-structured format.



- ◆ **Milestone charts.** These charts are similar to bar charts, but only identify the scheduled start or completion of major deliverables and key external interfaces. An example is the milestone schedule portion of Figure 6-21.
- ◆ **Project schedule network diagrams.** These diagrams are commonly presented in the activity-on-node diagram format showing activities and relationships without a time scale, sometimes referred to as a pure logic diagram, as shown in Figure 6-11, or presented in a time-scaled schedule network diagram format that is sometimes called a logic bar chart, as shown for the detailed schedule in Figure 6-21. These diagrams, with activity date information, usually show both the project network logic and the project's critical path schedule activities. This example also shows how each work package is planned as a series of related activities. Another presentation of the project schedule network diagram is a time-scaled logic diagram. These diagrams include a time scale and bars that represent the duration of activities with the logical relationships. They are optimized to show the relationships between activities where any number of activities may appear on the same line of the diagram in sequence.

Figure 6-21 shows schedule presentations for a sample project being executed, with the work in progress reported through as-of date or status date. For a simple project schedule model, Figure 6-21 reflects schedule presentations in the forms of (1) a milestone schedule as a milestone chart, (2) a summary schedule as a bar chart, and (3) a detailed schedule as a project schedule linked bar chart diagram. Figure 6-21 also visually shows the relationships among the different levels of detail of the project schedule.

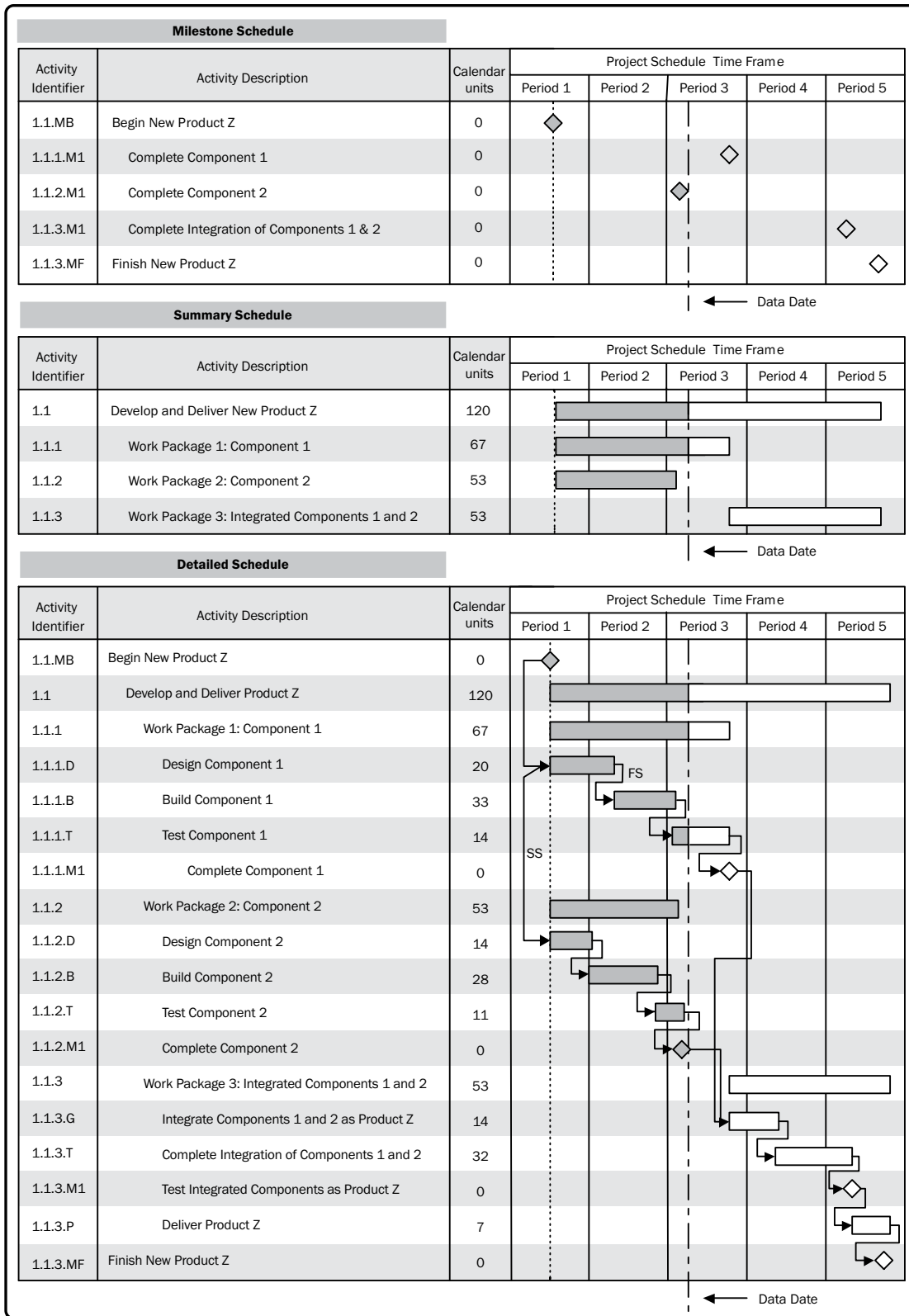

Figure 6-21. Project Schedule Presentations—Examples

6.5.3.3 SCHEDULE DATA

The schedule data for the project schedule model is the collection of information for describing and controlling the schedule. The schedule data includes, at a minimum, the schedule milestones, schedule activities, activity attributes, and documentation of all identified assumptions and constraints. The amount of additional data varies by application area. Information frequently supplied as supporting detail includes but is not limited to:

- ◆ Resource requirements by time period, often in the form of a resource histogram;
- ◆ Alternative schedules, such as best-case or worst-case, not resource-leveled or resource-leveled, or with or without imposed dates; and
- ◆ Applied schedule reserves.

Schedule data could also include such items as resource histograms, cash-flow projections, order and delivery schedules, or other relevant information.

6.5.3.4 PROJECT CALENDARS

A project calendar identifies working days and shifts that are available for scheduled activities. It distinguishes time periods in days or parts of days that are available to complete scheduled activities from time periods that are not available for work. A schedule model may require more than one project calendar to allow for different work periods for some activities to calculate the project schedule. The project calendars may be updated.

6.5.3.5 CHANGE REQUESTS

Described in Section 4.3.3.4. Modifications to the project scope or project schedule may result in change requests to the scope baseline, and/or other components of the project management plan. Change requests are processed for review and disposition through the Perform Integrated Change Control process (Section 4.6). Preventive actions may include recommended changes to eliminate or reduce the probability of negative schedule variances.

6.5.3.6 PROJECT MANAGEMENT PLAN UPDATES

Any change to the project management plan goes through the organization's change control process via a change request. Components that may require a change request for the project management plan include but are not limited to:

- ◆ **Schedule management plan.** Described in Section 6.1.3.1. The schedule management plan may be updated to reflect a change in the way the schedule was developed and will be managed.
- ◆ **Cost baseline.** Described in Section 7.3.3.1. Changes to the cost baseline are incorporated in response to approved changes in scope, resources, or cost estimates. In some cases, cost variances can be so severe that a revised cost baseline is needed to provide a realistic basis for performance measurement.

6.5.3.7 PROJECT DOCUMENTS UPDATES

Project documents that may be updated as a result of carrying out this process include but are not limited to:

- ◆ **Activity attributes.** Described in Section 6.2.3.2. Activity attributes are updated to include any revised resource requirements and any other revisions generated by the Develop Schedule process.
- ◆ **Assumption log.** Described in Section 4.1.3.2. The assumption log may be updated with changes to assumptions in duration, resource utilization, sequencing, or other information that is revealed as a result of developing the schedule model.
- ◆ **Duration estimates.** Described in Section 6.4.3.1. The number and availability of resources, along with the activity dependencies can result in a change to the duration estimates. If the resource-leveling analysis changes the resource requirements, then the duration estimates will likely need to be updated as well.
- ◆ **Lessons learned register.** Described in Section 4.4.3.1. The lessons learned register can be updated with techniques that were efficient and effective in developing the schedule model.
- ◆ **Resource requirements.** Described in Section 9.2.3.1. Resource leveling can have a significant effect on preliminary estimates for the types and quantities of resources required. If the resource-leveling analysis changes the resource requirements, then the resource requirements are updated.
- ◆ **Risk register.** Described in Section 11.2.3.1. The risk register may need to be updated to reflect opportunities or threats perceived through scheduling assumptions.

6.6 CONTROL SCHEDULE

Control Schedule is the process of monitoring the status of the project to update the project schedule and managing changes to the schedule baseline. The key benefit of this process is that the schedule baseline is maintained throughout the project. This process is performed throughout the project. The inputs, tools and techniques, and outputs of this process are depicted in Figure 6-22. Figure 6-23 depicts the data flow diagram of the process.

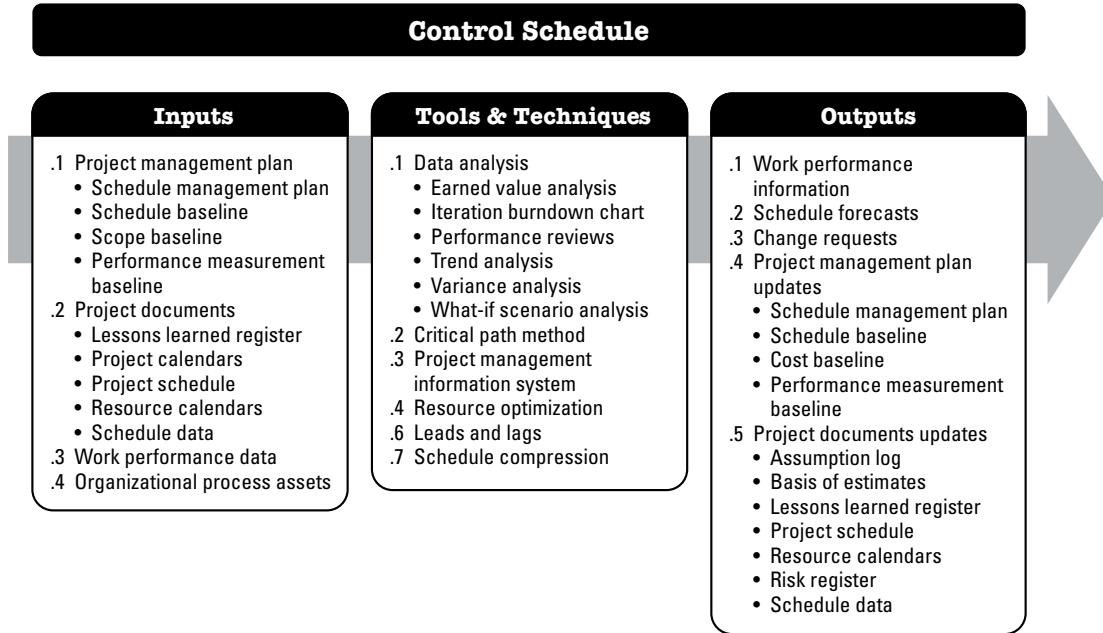

Figure 6-22. Control Schedule: Inputs, Tools & Techniques, and Outputs

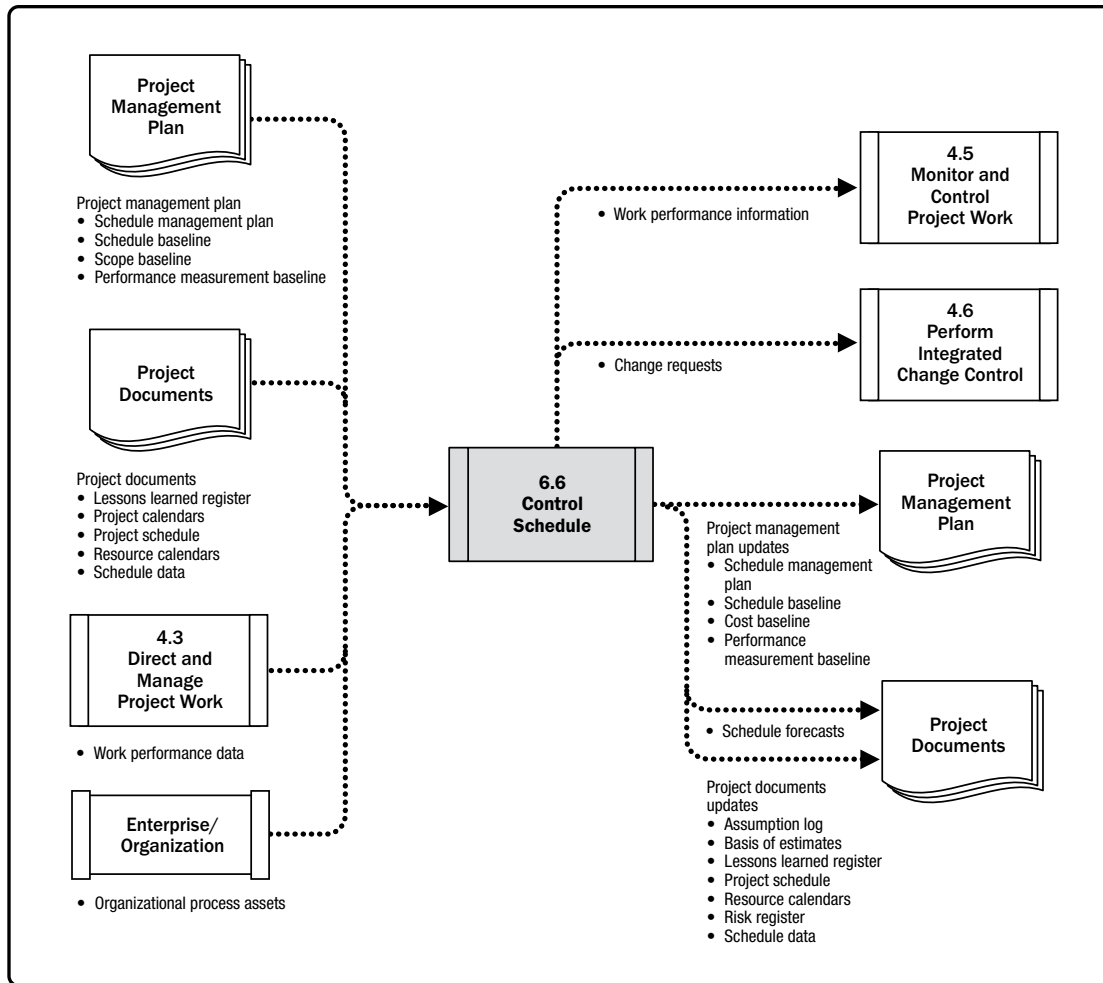

Figure 6-23. Control Schedule: Data Flow Diagram

Updating the schedule model requires knowing the actual performance to date. Any change to the schedule baseline can only be approved through the Perform Integrated Change Control process (Section 4.6). Control Schedule, as a component of the Perform Integrated Change Control process, is concerned with:

- ◆ Determining the current status of the project schedule,
- ◆ Influencing the factors that create schedule changes,
- ◆ Reconsidering necessary schedule reserves,
- ◆ Determining if the project schedule has changed, and
- ◆ Managing the actual changes as they occur.

When an agile approach is used, Control Schedule is concerned with:

- ◆ Determining the current status of the project schedule by comparing the total amount of work delivered and accepted against the estimates of work completed for the elapsed time cycle;
- ◆ Conducting retrospectives (scheduled reviews to record lessons learned) for correcting processes and improving, if required;
- ◆ Reprioritizing the remaining work plan (backlog);
- ◆ Determining the rate at which the deliverables are produced, validated, and accepted (velocity) in the given time per iteration (agreed-upon work cycle duration, typically 2 weeks or 1 month);
- ◆ Determining that the project schedule has changed; and
- ◆ Managing the actual changes as they occur.

When work is being contracted, regular and milestone status updates from contractors and suppliers are a means of ensuring the work is progressing as agreed upon to ensure the schedule is under control. Scheduled status reviews and walkthroughs should be done to ensure the contractor reports are accurate and complete.

6.6.1 CONTROL SCHEDULE: INPUTS

6.6.1.1 PROJECT MANAGEMENT PLAN

Described in Section 4.2.3.1. Project management plan components include but are not limited to:

- ◆ **Schedule management plan.** Described in Section 6.1.3.1. The schedule management describes the frequency that the schedule will be updated, how reserve will be used, and how the schedule will be controlled.
- ◆ **Schedule baseline.** Described in Section 6.5.3.1. The schedule baseline is compared with actual results to determine if a change, corrective action, or preventive action is necessary.
- ◆ **Scope baseline.** Described in Section 5.4.3.1. The project WBS, deliverables, constraints, and assumptions documented in the scope baseline are considered explicitly when monitoring and controlling the schedule baseline.
- ◆ **Performance measurement baseline.** Described in Section 4.2.3.1. When using earned value analysis the performance measurement baseline is compared to actual results to determine if a change, corrective action, or preventive action is necessary.

6.6.1.2 PROJECT DOCUMENTS

Project documents that can be considered as inputs for this process include but are not limited to:

- ◆ **Lessons learned register.** Described in Section 4.4.3.1. Lessons learned earlier in the project can be applied to later phases in the project to improve schedule control.
- ◆ **Project calendars.** Described in Section 6.5.3.4. A schedule model may require more than one project calendar to allow for different work periods for some activities to calculate the schedule forecasts.
- ◆ **Project schedule.** Described in Section 6.5.3.2. Project schedule refers to the most recent version with notations to indicate updates, completed activities, and started activities as of the indicated date.
- ◆ **Resource calendars.** Described in Section 9.2.1.2. Resource calendars show the availability of team and physical resources.
- ◆ **Schedule data.** Described in Section 6.5.3.3. Schedule data will be reviewed and updated in the Control Schedule process.

6.6.1.3 WORK PERFORMANCE DATA

Described in Section 4.3.3.2. Work performance data contains data on project status such as which activities have started, their progress (e.g., actual duration, remaining duration, and physical percent complete), and which activities have finished.

6.6.1.4 ORGANIZATIONAL PROCESS ASSETS

The organizational process assets that can influence the Control Schedule process include but are not limited to:

- ◆ Existing formal and informal schedule control-related policies, procedures, and guidelines;
- ◆ Schedule control tools; and
- ◆ Monitoring and reporting methods to be used.



6.6.2 CONTROL SCHEDULE: TOOLS AND TECHNIQUES

6.6.2.1 DATA ANALYSIS

Data analysis techniques that can be used for this process include but are not limited to:

- ◆ **Earned value analysis.** Described in Section 7.4.2.2. Schedule performance measurements such as schedule variance (SV) and schedule performance index (SPI) are used to assess the magnitude of variation to the original schedule baseline.
- ◆ **Iteration burndown chart.** This chart tracks the work that remains to be completed in the iteration backlog. It is used to analyze the variance with respect to an ideal burndown based on the work committed from iteration planning (see Section 6.4.2.8). A forecast trend line can be used to predict the likely variance at iteration completion and take appropriate actions during the course of the iteration. A diagonal line representing the ideal burndown and daily actual remaining work is then plotted. A trend line is then calculated to forecast completion based on remaining work. Figure 6-24 is an example of an iteration burndown chart.

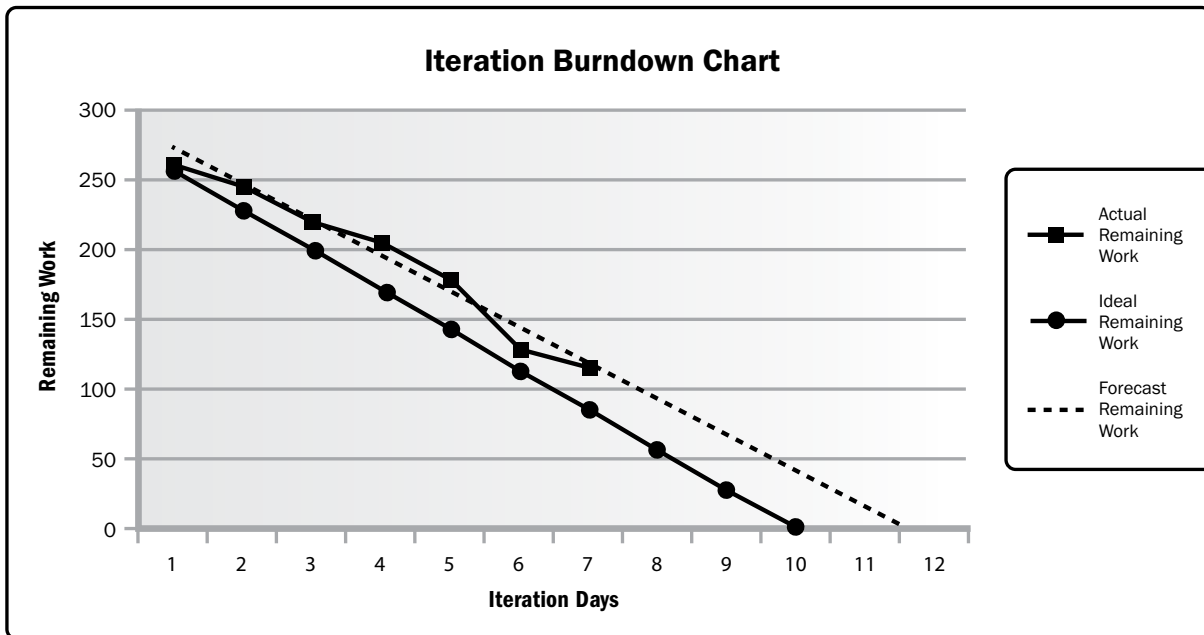

Figure 6-24. Iteration Burndown Chart

- ◆ **Performance reviews.** Performance reviews measure, compare, and analyze schedule performance against the schedule baseline such as actual start and finish dates, percent complete, and remaining duration for work in progress.
- ◆ **Trend analysis.** Described in Section 4.5.2.2. Trend analysis examines project performance over time to determine whether performance is improving or deteriorating. Graphical analysis techniques are valuable for understanding performance to date and for comparing to future performance goals in the form of completion dates.
- ◆ **Variance analysis.** Variance analysis looks at variances in planned versus actual start and finish dates, planned versus actual durations, and variances in float. Part of variance analysis is determining the cause and degree of variance relative to the schedule baseline (see Section 6.5.3.1), estimating the implications of those variances for future work to completion, and deciding whether corrective or preventive action is required. For example, a major delay on any activity not on the critical path may have little effect on the overall project schedule, while a much shorter delay on a critical or near-critical activity may require immediate action.
- ◆ **What-if scenario analysis.** Described in Section 6.5.2.4. What-if scenario analysis is used to assess the various scenarios guided by the output from the Project Risk Management processes to bring the schedule model into alignment with the project management plan and approved baseline.

6.6.2.2 CRITICAL PATH METHOD

Described in Section 6.5.2.2. Comparing the progress along the critical path can help determine schedule status. The variance on the critical path will have a direct impact on the project end date. Evaluating the progress of activities on near critical paths can identify schedule risk.

6.6.2.3 PROJECT MANAGEMENT INFORMATION SYSTEM (PMIS)

Described in Section 4.3.2.2. Project management information systems include scheduling software that provides the ability to track planned dates versus actual dates, to report variances to and progress made against the schedule baseline, and to forecast the effects of changes to the project schedule model.

6.6.2.4 RESOURCE OPTIMIZATION

Described in Section 6.5.2.3. Resource optimization techniques involve the scheduling of activities and the resources required by those activities while taking into consideration both the resource availability and the project time.

6.6.2.5 LEADS AND LAGS

Adjusting leads and lags is applied during network analysis to find ways to bring project activities that are behind into alignment with the plan. For example, on a project to construct a new office building, the landscaping can be adjusted to start before the exterior work of the building is completed by increasing the lead time in the relationship, or a technical writing team can adjust the start of editing the draft of a large document immediately after the document is written by eliminating or decreasing lag time.

6.6.2.6 SCHEDULE COMPRESSION

Schedule compression techniques (see Section 6.5.2.6) are used to find ways to bring project activities that are behind into alignment with the plan by fast tracking or crashing the schedule for the remaining work.

6.6.3 CONTROL SCHEDULE: OUTPUTS

6.6.3.1 WORK PERFORMANCE INFORMATION

Described in Section 4.5.1.3. Work performance information includes information on how the project work is performing compared to the schedule baseline. Variances in the start and finish dates and the durations can be calculated at the work package level and control account level. For projects using earned value analysis, the (SV) and (SPI) are documented for inclusion in work performance reports (see Section 4.5.3.1).

6.6.3.2 SCHEDULE FORECASTS

Schedule updates are forecasts of estimates or predictions of conditions and events in the project's future based on information and knowledge available at the time of the forecast. Forecasts are updated and reissued based on work performance information provided as the project is executed. The information is based on the project's past performance and expected future performance based on corrective or preventive actions. This can include earned value performance indicators, as well as schedule reserve information that could impact the project in the future.

6.6.3.3 CHANGE REQUESTS

Described in Section 4.3.3.4. Schedule variance analysis, as well as reviews of progress reports, results of performance measures, and modifications to the project scope or project schedule, may result in change requests to the schedule baseline, scope baseline, and/or other components of the project management plan. Change requests are processed for review and disposition through the Perform Integrated Change Control process (Section 4.6). Preventive actions may include recommended changes to eliminate or reduce the probability of negative schedule variances.

6.6.3.4 PROJECT MANAGEMENT PLAN UPDATES

Any change to the project management plan goes through the organization's change control process via a change request. Components that may require a change request for the project management plan include but are not limited to:

- ◆ **Schedule management plan.** Described in Section 6.1.3.1. The schedule management plan may be updated to reflect a change in the way the schedule is managed.
- ◆ **Schedule baseline.** Described in Section 6.5.3.1. Changes to the schedule baseline are incorporated in response to approved change requests related to change in project scope, resources, or activity duration estimates. The schedule baseline may be updated to reflect changes caused by schedule compression techniques or performance issues.
- ◆ **Cost baseline.** Described in Section 7.3.3.1. Changes to the cost baseline are incorporated in response to approved changes in scope, resources, or cost estimates.
- ◆ **Performance measurement baseline.** Described in Section 4.2.3.1. Changes to the performance measurement baseline are incorporated in response to approved changes in scope, schedule performance, or cost estimates. In some cases, the performance variances can be so severe that a change request is put forth to revise the performance measurement baseline to provide a realistic basis for performance measurement.

6.6.3.5 PROJECT DOCUMENTS UPDATES

Project documents that may be updated as a result of carrying out this process include but are not limited to:

- ◆ **Assumption log.** Described in Section 4.1.3.2. Schedule performance may indicate the need to revise assumptions on activity sequencing, durations, and productivity.
- ◆ **Basis of estimates.** Described in Section 6.4.3.2. Schedule performance may indicate the need to revise the way duration estimates were developed.
- ◆ **Lessons learned register.** Described in Section 4.4.3.1. The lessons learned register can be updated with techniques that were effective in maintaining the schedule, causes of variances, and corrective actions that were used to respond to schedule variances.
- ◆ **Project schedule.** An updated project schedule (see Section 6.5.3.2) will be generated from the schedule model populated with updated schedule data to reflect the schedule changes and manage the project.
- ◆ **Resource calendars.** Described in Section 9.2.1.2. Resource calendars are updated to reflect changes to the utilization of resource calendars that were the result of optimizing resources, schedule compression, and corrective or preventive actions.
- ◆ **Risk register.** Described in Section 11.2.3.1. The risk register and risk response plans within it, may be updated based on the risks that may arise due to schedule compression techniques.
- ◆ **Schedule data.** Described in Section 6.5.3.3. New project schedule network diagrams may be developed to display approved remaining durations and approved modifications to the schedule. In some cases, project schedule delays can be so severe that a new target schedule with forecasted start and finish dates is needed to provide realistic data for directing the work, measuring performance, and measuring progress.

7

PROJECT COST MANAGEMENT

Project Cost Management includes the processes involved in planning, estimating, budgeting, financing, funding, managing, and controlling costs so that the project can be completed within the approved budget. The Project Cost Management processes are:

7.1 Plan Cost Management—The process of defining how the project costs will be estimated, budgeted, managed, monitored, and controlled.

7.2 Estimate Costs—The process of developing an approximation of the monetary resources needed to complete project work.

7.3 Determine Budget—The process of aggregating the estimated costs of individual activities or work packages to establish an authorized cost baseline.

7.4 Control Costs—The process of monitoring the status of the project to update the project costs and manage changes to the cost baseline.

Figure 7-1 provides an overview of the Project Cost Management processes. The Project Cost Management processes are presented as discrete processes with defined interfaces, while in practice they overlap and interact in ways that cannot be completely detailed in the *PMBOK® Guide*. These processes interact with each other and with processes in other Knowledge Areas.

On some projects, especially those of smaller scope, cost estimating and cost budgeting are tightly linked and can be viewed as a single process that can be performed by a single person over a relatively short period of time. They are presented here as distinct processes because the tools and techniques for each are different. The ability to influence cost is greatest at the early stages of the project, making early scope definition critical (see Section 5.3).

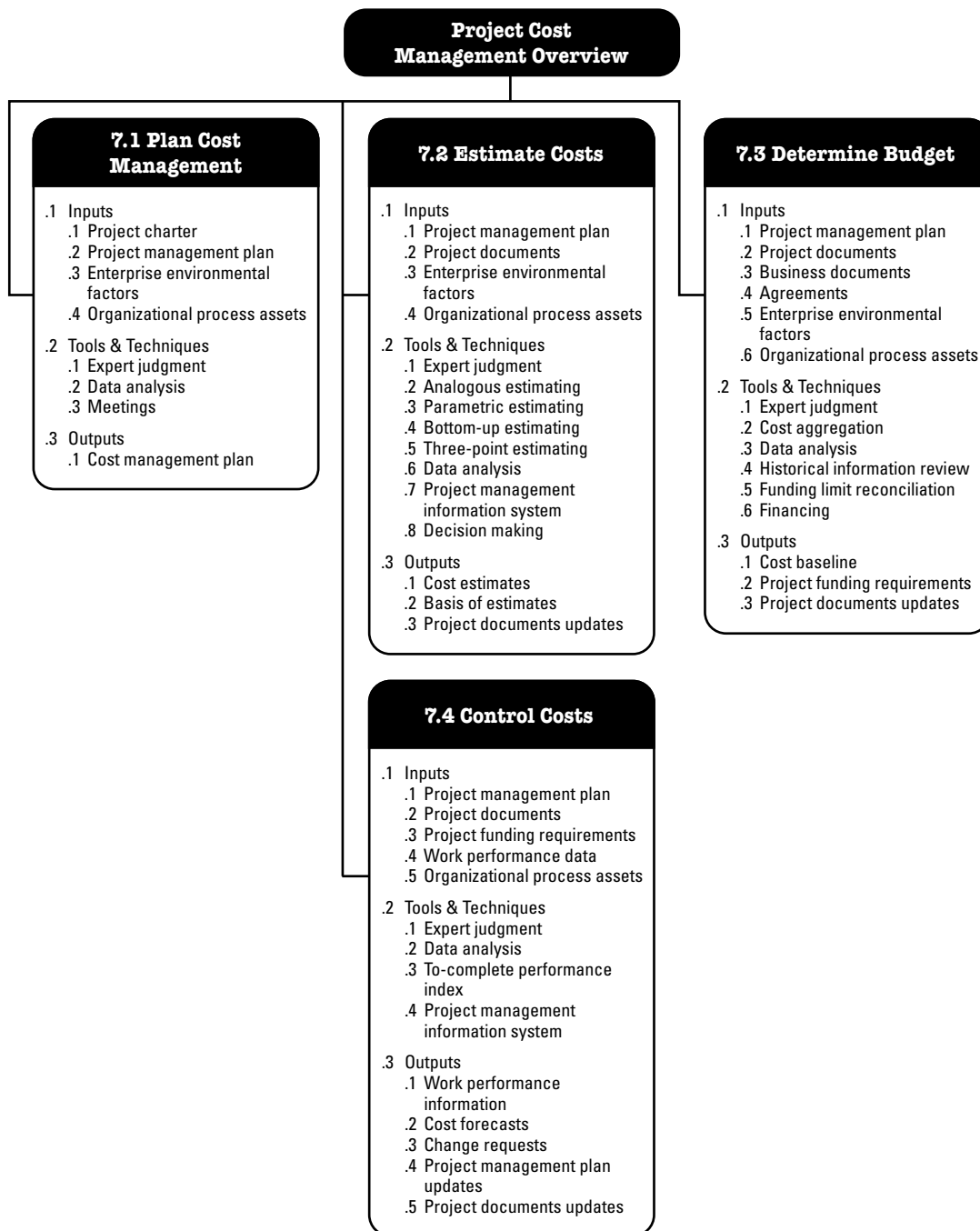

Figure 7-1. Project Cost Management Overview

KEY CONCEPTS FOR PROJECT COST MANAGEMENT

Project Cost Management is primarily concerned with the cost of the resources needed to complete project activities. Project Cost Management should consider the effect of project decisions on the subsequent recurring cost of using, maintaining, and supporting the product, service, or result of the project. For example, limiting the number of design reviews can reduce the cost of the project but could increase the resulting product's operating costs.

Another aspect of cost management is recognizing that different stakeholders measure project costs in different ways and at different times. For example, the cost of an acquired item may be measured when the acquisition decision is made or committed, the order is placed, the item is delivered, or the actual cost is incurred or recorded for project accounting purposes. In many organizations, predicting and analyzing the prospective financial performance of the project's product is performed outside of the project. In others, such as a capital facilities project, Project Cost Management can include this work. When such predictions and analyses are included, Project Cost Management may address additional processes and numerous general financial management techniques such as return on investment, discounted cash flow, and investment payback analysis.

TRENDS AND EMERGING PRACTICES IN PROJECT COST MANAGEMENT

Within the practice of Project Cost Management, trends include the expansion of earned value management (EVM) to include the concept of earned schedule (ES).

ES is an extension to the theory and practice of EVM. Earned schedule theory replaces the schedule variance measures used in traditional EVM (earned value – planned value) with ES and actual time (AT). Using the alternate equation for calculating schedule variance $ES - AT$, if the amount of earned schedule is greater than 0, then the project is considered ahead of schedule. In other words, the project earned more than planned at a given point in time. The schedule performance index (SPI) using earned schedule metrics is ES/AT . This indicates the efficiency with which work is being accomplished. Earned schedule theory also provides formulas for forecasting the project completion date, using earned schedule, actual time, and estimated duration.

TAILORING CONSIDERATIONS

Because each project is unique, the project manager may need to tailor the way Project Cost Management processes are applied. Considerations for tailoring include but are not limited to:

- ◆ **Knowledge management.** Does the organization have a formal knowledge management and financial database repository that a project manager is required to use and that is readily accessible?
- ◆ **Estimating and budgeting.** Does the organization have existing formal or informal cost estimating and budgeting-related policies, procedures, and guidelines?
- ◆ **Earned value management.** Does the organization use earned value management in managing projects?
- ◆ **Use of agile approach.** Does the organization use agile methodologies in managing projects? How does this impact cost estimating?
- ◆ **Governance.** Does the organization have formal or informal audit and governance policies, procedures, and guidelines?

CONSIDERATIONS FOR AGILE/ADAPTIVE ENVIRONMENTS

Projects with high degrees of uncertainty or those where the scope is not yet fully defined may not benefit from detailed cost calculations due to frequent changes. Instead, lightweight estimation methods can be used to generate a fast, high-level forecast of project labor costs, which can then be easily adjusted as changes arise. Detailed estimates are reserved for short-term planning horizons in a just-in-time fashion.

In cases where high-variability projects are also subject to strict budgets, the scope and schedule are more often adjusted to stay within cost constraints.

7.1 PLAN COST MANAGEMENT

Plan Cost Management is the process of defining how the project costs will be estimated, budgeted, managed, monitored, and controlled. The key benefit of this process is that it provides guidance and direction on how the project costs will be managed throughout the project. This process is performed once or at predefined points in the project. The inputs, tools and techniques, and outputs of this process are depicted in Figure 7-2. Figure 7-3 depicts the data flow diagram of the process.

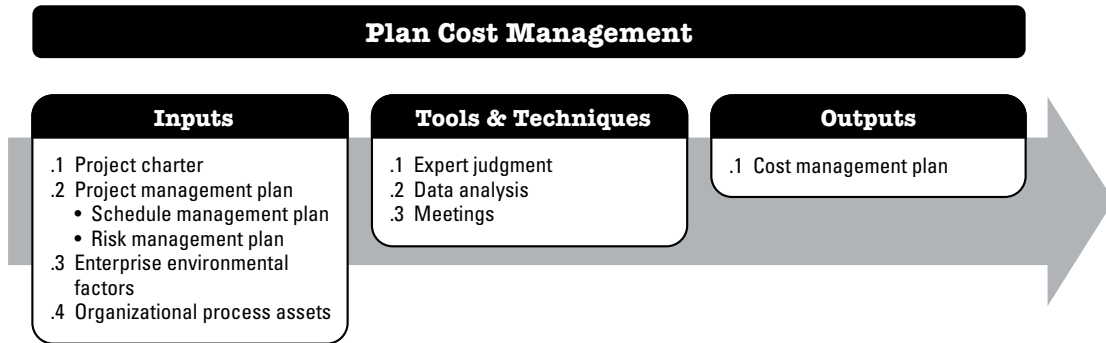

Figure 7-2. Plan Cost Management: Inputs, Tools & Techniques, and Outputs

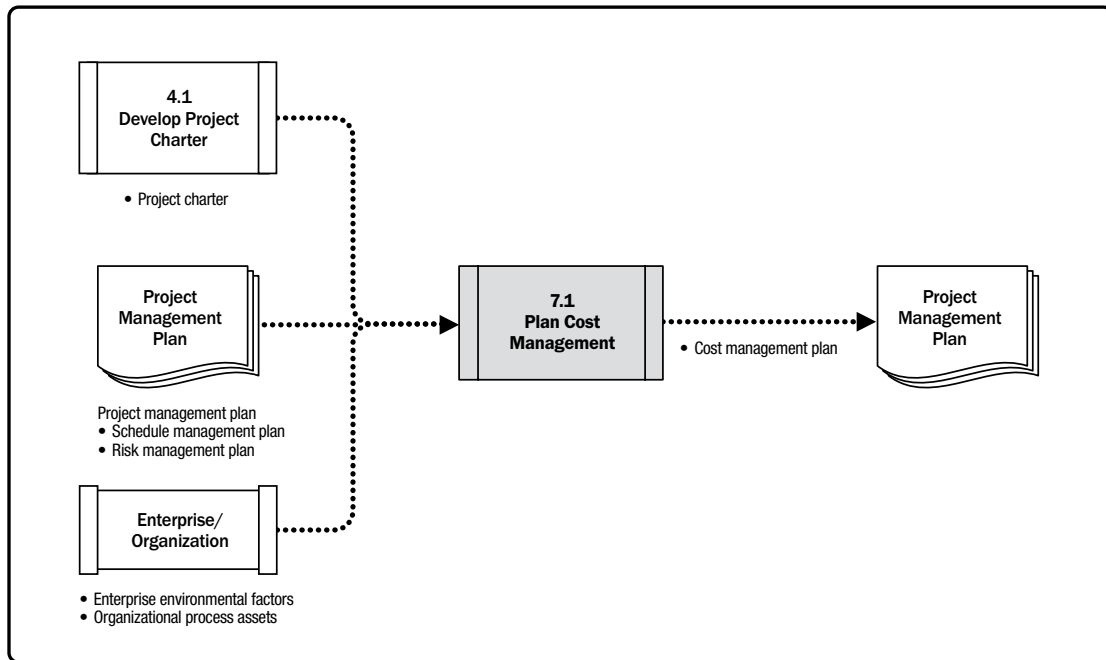

Figure 7-3. Plan Cost Management: Data Flow Diagram

The cost management planning effort occurs early in project planning and sets the framework for each of the cost management processes so that performance of the processes will be efficient and coordinated. The cost management processes and their associated tools and techniques are documented in the cost management plan. The cost management plan is a component of the project management plan.

7.1.1 PLAN COST MANAGEMENT: INPUTS

7.1.1.1 PROJECT CHARTER

Described in Section 4.2.3.1. The project charter provides the preapproved financial resources from which the detailed project costs are developed. The project charter also defines the project approval requirements that will influence the management of the project costs.

7.1.1.2 PROJECT MANAGEMENT PLAN

Described in Section 4.2.3.1. Project management plan components include but are not limited to:

- ◆ **Schedule management plan.** Described in Section 6.1.3.1. The schedule management plan establishes the criteria and the activities for developing, monitoring, and controlling the schedule. The schedule management plan provides processes and controls that will impact cost estimation and management.
- ◆ **Risk management plan.** Described in Section 11.1.3.1. The risk management plan provides the approach for identifying, analyzing, and monitoring risks. The risk management plan provides processes and controls that will impact cost estimation and management.

7.1.1.3 ENTERPRISE ENVIRONMENTAL FACTORS

The enterprise environmental factors that can influence the Plan Cost Management process include but are not limited to:

- ◆ Organizational culture and structure can influence cost management.
- ◆ Market conditions describe what products, services, and results are available in the regional and global markets.
- ◆ Currency exchange rates for project costs are sourced from more than one country.

- ◆ Published commercial information such as resource cost rate information is often available from commercial databases that track skills and human resource costs, and provide standard costs for material and equipment. Published seller price lists are another source of information.
- ◆ Project management information system provides alternative possibilities for managing cost.
- ◆ Productivity differences in different parts of the world can have a large influence on the cost of projects.

7.1.1.4 ORGANIZATIONAL PROCESS ASSETS

The organizational process assets that can influence the Plan Cost Management process include but are not limited to:

- ◆ Financial controls procedures (e.g., time reporting, required expenditure and disbursement reviews, accounting codes, and standard contract provisions);
- ◆ Historical information and lessons learned repository;
- ◆ Financial databases; and
- ◆ Existing formal and informal cost estimating and budgeting-related policies, procedures, and guidelines.

7.1.2 PLAN COST MANAGEMENT: TOOLS AND TECHNIQUES

7.1.2.1 EXPERT JUDGMENT

Described in Section 4.1.2.1 Expertise should be considered from individuals or groups with specialized knowledge or training in the following topics:

- ◆ Previous similar projects;
- ◆ Information in the industry, discipline, and application area;
- ◆ Cost estimating and budgeting; and
- ◆ Earned value management.



7.1.2.2 DATA ANALYSIS

A data analysis technique that can be used for this process includes but is not limited to alternatives analysis. Alternatives analysis can include reviewing strategic funding options such as: self-funding, funding with equity, or funding with debt. It can also include consideration of ways to acquire project resources such as making, purchasing, renting, or leasing.

7.1.2.3 MEETINGS

Project teams may hold planning meetings to develop the cost management plan. Attendees may include the project manager, the project sponsor, selected project team members, selected stakeholders, anyone with responsibility for project costs, and others as needed.

7.1.3 PLAN COST MANAGEMENT: OUTPUTS

7.1.3.1 COST MANAGEMENT PLAN

The cost management plan is a component of the project management plan and describes how the project costs will be planned, structured, and controlled. The cost management processes and their associated tools and techniques are documented in the cost management plan.

For example, the cost management plan can establish the following:

- ◆ **Units of measure.** Each unit used in measurements (such as staff hours, staff days, or weeks for time measures; meters, liters, tons, kilometers, or cubic yards for quantity measures; or lump sum in currency form) is defined for each of the resources.
- ◆ **Level of precision.** This is the degree to which cost estimates will be rounded up or down (e.g., US\$995.59 to US\$1,000), based on the scope of the activities and magnitude of the project.
- ◆ **Level of accuracy.** The acceptable range (e.g., $\pm 10\%$) used in determining realistic cost estimates is specified, and may include an amount for contingencies.

- ◆ **Organizational procedures links.** The work breakdown structure (WBS) (Section 5.4) provides the framework for the cost management plan, allowing for consistency with the estimates, budgets, and control of costs. The WBS component used for the project cost accounting is called the control account. Each control account is assigned a unique code or account number(s) that links directly to the performing organization's accounting system.
- ◆ **Control thresholds.** Variance thresholds for monitoring cost performance may be specified to indicate an agreed-upon amount of variation to be allowed before some action needs to be taken. Thresholds are typically expressed as percentage deviations from the baseline plan.
- ◆ **Rules of performance measurement.** Earned value management (EVM) rules of performance measurement are set. For example, the cost management plan may:
 - Define the points in the WBS at which measurement of control accounts will be performed;
 - Establish the EVM techniques (e.g., weighted milestones, fixed-formula, percent complete, etc.) to be employed; and
 - Specify tracking methodologies and the EVM computation equations for calculating projected estimate at completion (EAC) forecasts to provide a validity check on the bottom-up EAC.
- ◆ **Reporting formats.** The formats and frequency for the various cost reports are defined.
- ◆ **Additional details.** Additional details about cost management activities include but are not limited to:
 - Description of strategic funding choices,
 - Procedure to account for fluctuations in currency exchange rates, and
 - Procedure for project cost recording.

For more specific information regarding earned value management, refer to the *Practice Standard for Earned Value Management – Second Edition* [17].

7.2 ESTIMATE COSTS

Estimate Costs is the process of developing an approximation of the cost of resources needed to complete project work. The key benefit of this process is that it determines the monetary resources required for the project. This process is performed periodically throughout the project as needed. The inputs, tools and techniques, and outputs of this process are depicted in Figure 7-4. Figure 7-5 depicts the data flow diagram of the process.

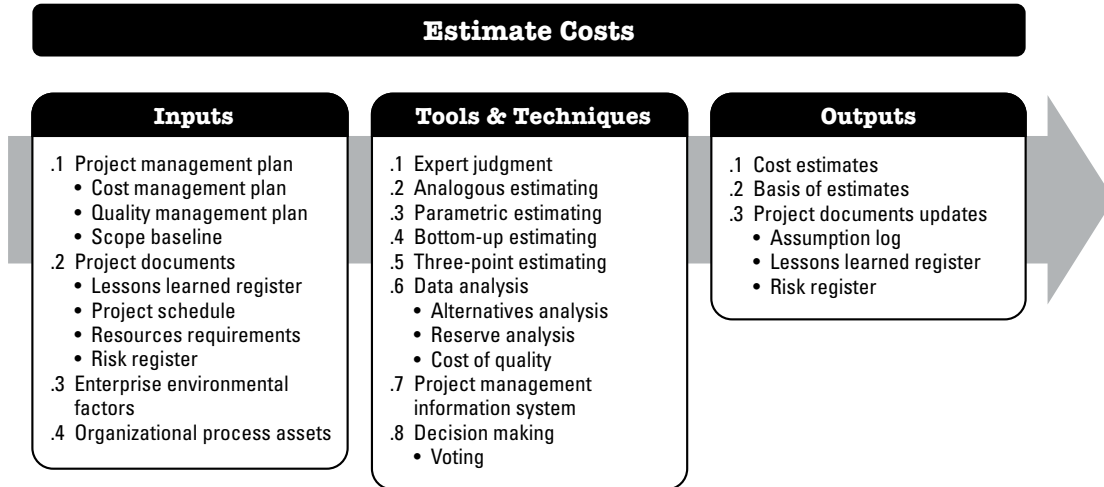

Figure 7-4. Estimate Costs: Inputs, Tools & Techniques, and Outputs

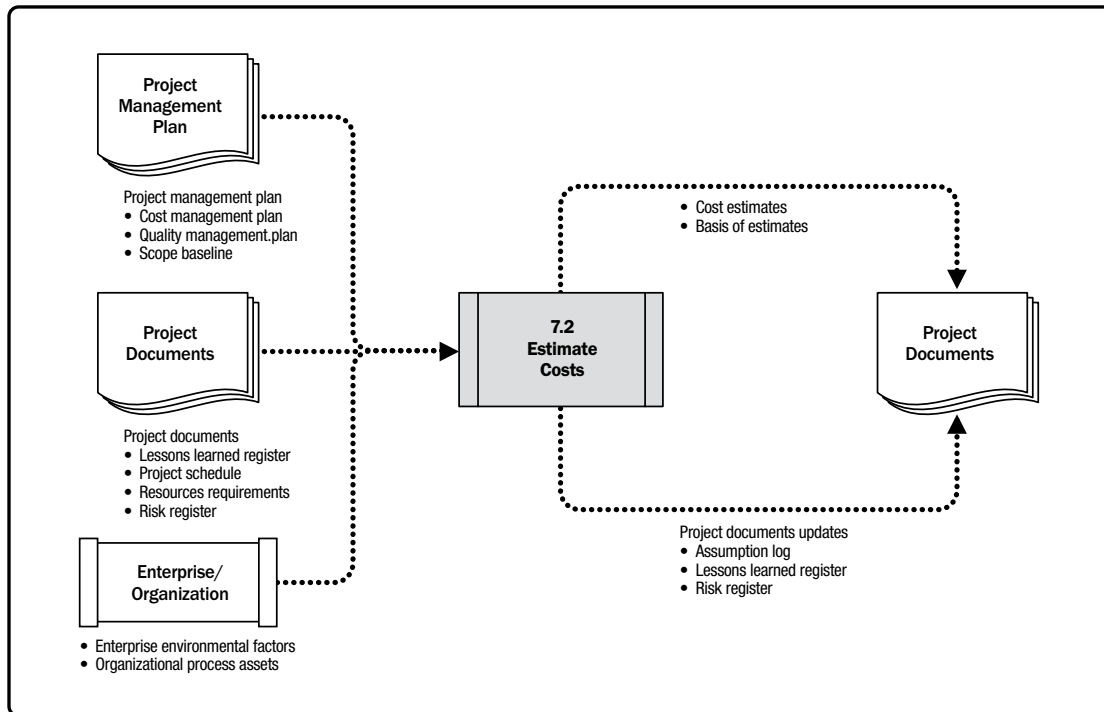

Figure 7-5. Estimate Costs: Data Flow Diagram

A cost estimate is a quantitative assessment of the likely costs for resources required to complete the activity. It is a prediction that is based on the information known at a given point in time. Cost estimates include the identification and consideration of costing alternatives to initiate and complete the project. Cost trade-offs and risks should be considered, such as make versus buy, buy versus lease, and the sharing of resources in order to achieve optimal costs for the project.

Cost estimates are generally expressed in units of some currency (i.e., dollars, euros, yen, etc.), although in some instances other units of measure, such as staff hours or staff days, are used to facilitate comparisons by eliminating the effects of currency fluctuations.

Cost estimates should be reviewed and refined during the course of the project to reflect additional detail as it becomes available and assumptions are tested. The accuracy of a project estimate will increase as the project progresses through the project life cycle. For example, a project in the initiation phase may have a rough order of magnitude (ROM) estimate in the range of –25% to +75%. Later in the project, as more information is known, definitive estimates could narrow the range of accuracy to –5% to +10%. In some organizations, there are guidelines for when such refinements can be made and the degree of confidence or accuracy that is expected.

Costs are estimated for all resources that will be charged to the project. This includes but is not limited to labor, materials, equipment, services, and facilities, as well as special categories such as an inflation allowance, cost of financing, or contingency costs. Cost estimates may be presented at the activity level or in summary form.

7.2.1 ESTIMATE COSTS: INPUTS

7.2.1.1 PROJECT MANAGEMENT PLAN

Described in Section 4.2.3.1. Project management plan components include but are not limited to:

- ◆ **Cost management plan.** Described in Section 7.1.3.1. The cost management plan describes estimating methods that can be used and the level of precision and accuracy required for the cost estimate.
- ◆ **Quality management plan.** Described in Section 8.1.3.1. The quality management plan describes the activities and resources necessary for the project management team to achieve the quality objectives set for the project.



- ◆ **Scope baseline.** Described in Section 5.4.3.1. The scope baseline includes the project scope statement, WBS, and WBS dictionary:
 - *Project scope statement.* The scope statement (Section 5.3.3.1) reflects funding constraints by period for the expenditure of project funds or other financial assumptions and constraints.
 - *Work breakdown structure.* The WBS (Section 5.4.3.1) provides the relationships among all the project deliverables and their various components.
 - *WBS dictionary.* The WBS dictionary (Section 5.4.3.) and related detailed statements of work provide an identification of the deliverables and a description of the work in each WBS component required to produce each deliverable.

7.2.1.2 PROJECT DOCUMENTS

Project documents that can be considered as inputs for this process include but are not limited to:

- ◆ **Lessons learned register.** Described in Section 4.4.3.1. Lessons learned earlier in the project with regard to developing cost estimates can be applied to later phases in the project to improve the accuracy and precision of the cost estimates.
- ◆ **Project schedule.** Described in Section 6.5.3.2. The schedule includes the type, quantity, and amount of time that team and physical resources will be active on the project. The duration estimates (Section 6.4.3.1) will affect cost estimates when resources are charged per unit of time and when there are seasonal fluctuations in costs. The schedule also provides useful information for projects that incorporate the cost of financing (including interest charges).
- ◆ **Resource requirements.** Described in Section 9.2.3.1. Resource requirements identify the types and quantities of resources required for each work package or activity.
- ◆ **Risk register.** Described in Section 11.2.3.1. The risk register contains details of individual project risks that have been identified and prioritized, and for which risk responses are required. The risk register provides detailed information that can be used to estimate costs.

7.2.1.3 ENTERPRISE ENVIRONMENTAL FACTORS

The enterprise environmental factors that can influence the Estimate Costs process include but are not limited to:

- ◆ **Market conditions.** These conditions describe what products, services, and results are available in the market, from whom, and under what terms and conditions. Regional and/or global supply and demand conditions greatly influence resource costs.
- ◆ **Published commercial information.** Resource cost rate information is often available from commercial databases that track skills and human resource costs, and provide standard costs for material and equipment. Published seller price lists are another source of information.
- ◆ **Exchange rates and inflation.** For large-scale projects that extend multiple years with multiple currencies, the fluctuations of currencies and inflation need to be understood and built into the Estimate Cost process.

7.2.1.4 ORGANIZATIONAL PROCESS ASSETS

The organizational process assets that can influence the Estimate Costs process include but are not limited to:

- ◆ Cost estimating policies,
- ◆ Cost estimating templates,
- ◆ Historical information and lessons learned repository.

7.2.2 ESTIMATE COSTS: TOOLS AND TECHNIQUES

7.2.2.1 EXPERT JUDGMENT

Described in Section 4.1.2.1 Expertise should be considered from individuals or groups with specialized knowledge or training in the following topics:

- ◆ Previous similar projects;
- ◆ Information in the industry, discipline, and application area; and
- ◆ Cost estimating methods.

7.2.2.2 ANALOGOUS ESTIMATING

Described in Section 6.4.2.2. Analogous cost estimating uses values, or attributes, of a previous project that are similar to the current project. Values and attributes of the projects may include but are not limited to: scope, cost, budget, duration, and measures of scale (e.g., size, weight). Comparison of these project values, or attributes, becomes the basis for estimating the same parameter or measurement for the current project.

7.2.2.3 PARAMETRIC ESTIMATING

Described in Section 6.4.2.3. Parametric estimating uses a statistical relationship between relevant historical data and other variables (e.g., square footage in construction) to calculate a cost estimate for project work. This technique can produce higher levels of accuracy depending on the sophistication and underlying data built into the model. Parametric cost estimates can be applied to a total project or to segments of a project, in conjunction with other estimating methods.

7.2.2.4 BOTTOM-UP ESTIMATING

Described in Section 6.4.2.5. Bottom-up estimating is a method of estimating a component of work. The cost of individual work packages or activities is estimated to the greatest level of specified detail. The detailed cost is then summarized or “rolled up” to higher levels for subsequent reporting and tracking purposes. The cost and accuracy of bottom-up cost estimating are typically influenced by the size or other attributes of the individual activity or work package.

7.2.2.5 THREE-POINT ESTIMATING

Described in Section 6.4.2.4. The accuracy of single-point cost estimates may be improved by considering estimation uncertainty and risk and using three estimates to define an approximate range for an activity’s cost:

- ◆ **Most likely (CM).** The cost of the activity, based on realistic effort assessment for the required work and any predicted expenses.
- ◆ **Optimistic (CO).** The cost based on analysis of the best-case scenario for the activity.
- ◆ **Pessimistic (CP).** The cost based on analysis of the worst-case scenario for the activity.

Depending on the assumed distribution of values within the range of the three estimates, the expected cost, cE , can be calculated using a formula. Two commonly used formulas are triangular and beta distributions. The formulas are:

◆ **Triangular distribution.** $cE = (cO + cM + cP) / 3$

◆ **Beta distribution.** $cE = (cO + 4cM + cP) / 6$

Cost estimates based on three points with an assumed distribution provide an expected cost and clarify the range of uncertainty around the expected cost.

7.2.2.6 DATA ANALYSIS

Data analysis techniques that can be used in the Estimate Costs process include but are not limited to:

◆ **Alternatives analysis.** Alternatives analysis is a technique used to evaluate identified options in order to select which options or approaches to use to execute and perform the work of the project. An example would be evaluating the cost, schedule, resource, and quality impacts of buying versus making a deliverable.

◆ **Reserve analysis.** Cost estimates may include contingency reserves (sometimes called contingency allowances) to account for cost uncertainty. Contingency reserves are the budget within the cost baseline that is allocated for identified risks. Contingency reserves are often viewed as the part of the budget intended to address the known-unknowns that can affect a project. For example, rework for some project deliverables could be anticipated, while the amount of this rework is unknown. Contingency reserves may be estimated to account for this unknown amount of rework. Contingency reserves can be provided at any level from the specific activity to the entire project. The contingency reserve may be a percentage of the estimated cost, a fixed number, or may be developed by using quantitative analysis methods.

As more precise information about the project becomes available, the contingency reserve may be used, reduced, or eliminated. Contingency should be clearly identified in cost documentation. Contingency reserves are part of the cost baseline and the overall funding requirements for the project.

◆ **Cost of quality.** Assumptions about costs of quality (Section 8.1.2.3) may be used to prepare the estimates. This includes evaluating the cost impact of additional investment in conformance versus the cost of nonconformance. It can also include looking at short-term cost reductions versus the implication of more frequent problems later on in the product life cycle.

7.2.2.7 PROJECT MANAGEMENT INFORMATION SYSTEM (PMIS)

Described in Section 4.3.2.2. The project management information system can include spreadsheets, simulation software, and statistical analysis tools to assist with cost estimating. Such tools simplify the use of some cost-estimating techniques and thereby facilitate rapid consideration of cost estimate alternatives.

7.2.2.8 DECISION MAKING

The decision-making techniques that can be used in the Estimate Costs process include but are not limited to voting. Described in Section 5.2.2.4, voting is an assessment process having multiple alternatives with an expected outcome in the form of future actions. These techniques are useful for engaging team members to improve estimate accuracy and commitment to the emerging estimates.

7.2.3 ESTIMATE COSTS: OUTPUTS

7.2.3.1 COST ESTIMATES

Cost estimates include quantitative assessments of the probable costs required to complete project work, as well as contingency amounts to account for identified risks, and management reserve to cover unplanned work. Cost estimates can be presented in summary form or in detail. Costs are estimated for all resources that are applied to the cost estimate. This includes but is not limited to direct labor, materials, equipment, services, facilities, information technology, and special categories such as cost of financing (including interest charges), an inflation allowance, exchange rates, or a cost contingency reserve. Indirect costs, if they are included in the project estimate, can be included at the activity level or at higher levels.

7.2.3.2 BASIS OF ESTIMATES

The amount and type of additional details supporting the cost estimate vary by application area. Regardless of the level of detail, the supporting documentation should provide a clear and complete understanding of how the cost estimate was derived.

Supporting detail for cost estimates may include:

- ◆ Documentation of the basis of the estimate (i.e., how it was developed),
- ◆ Documentation of all assumptions made,
- ◆ Documentation of any known constraints,
- ◆ Documentation of identified risks included when estimating costs,
- ◆ Indication of the range of possible estimates (e.g., US\$10,000 (±10%) to indicate that the item is expected to cost between a range of values), and
- ◆ Indication of the confidence level of the final estimate.

7.2.3.3 PROJECT DOCUMENTS UPDATES

Project documents that may be updated as a result of carrying out this process include but are not limited to:

- ◆ **Assumption log.** Described in Section 4.1.3.2. During the Cost Estimates process, new assumptions may be made, new constraints may be identified, and existing assumptions or constraints may be revisited and changed. The assumption log should be updated with this new information.
- ◆ **Lessons learned register.** Described in Section 4.4.3.1. The lessons learned register can be updated with techniques that were efficient and effective in developing cost estimates.
- ◆ **Risk register.** Described in Section 11.2.3.1. The risk register may be updated when appropriate risk responses are chosen and agreed upon during the Estimate Cost process.



7.3 DETERMINE BUDGET

Determine Budget is the process of aggregating the estimated costs of individual activities or work packages to establish an authorized cost baseline. The key benefit of this process is that it determines the cost baseline against which project performance can be monitored and controlled. This process is performed once or at predefined points in the project. The inputs, tools and techniques, and outputs of this process are depicted in Figure 7-6. Figure 7-7 depicts the data flow diagram of the process.

A project budget includes all the funds authorized to execute the project. The cost baseline is the approved version of the time-phased project budget that includes contingency reserves, but excludes management reserves.

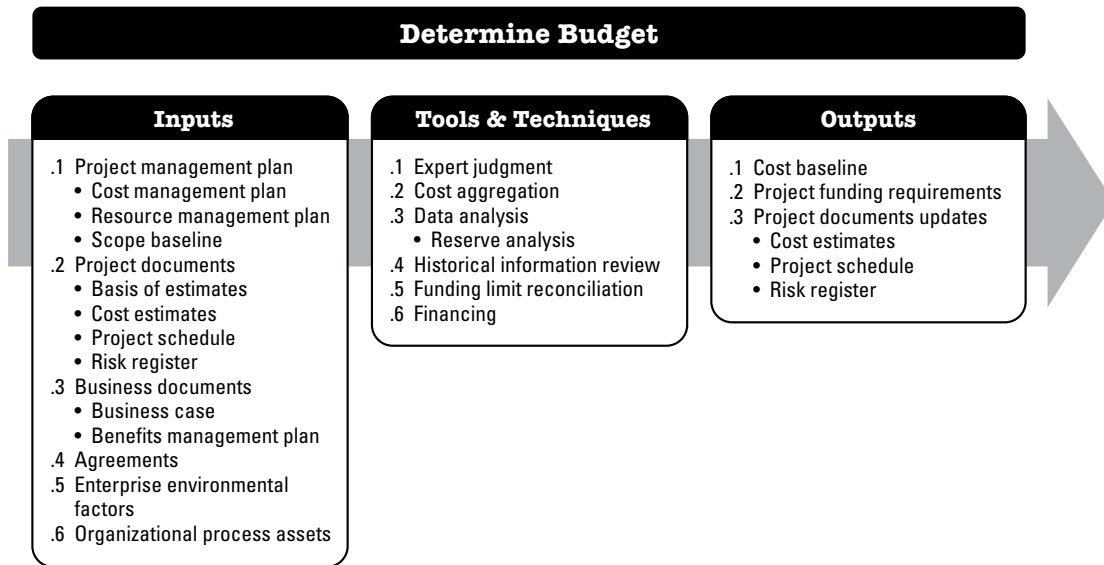

Figure 7-6. Determine Budget: Inputs, Tools & Techniques, and Outputs

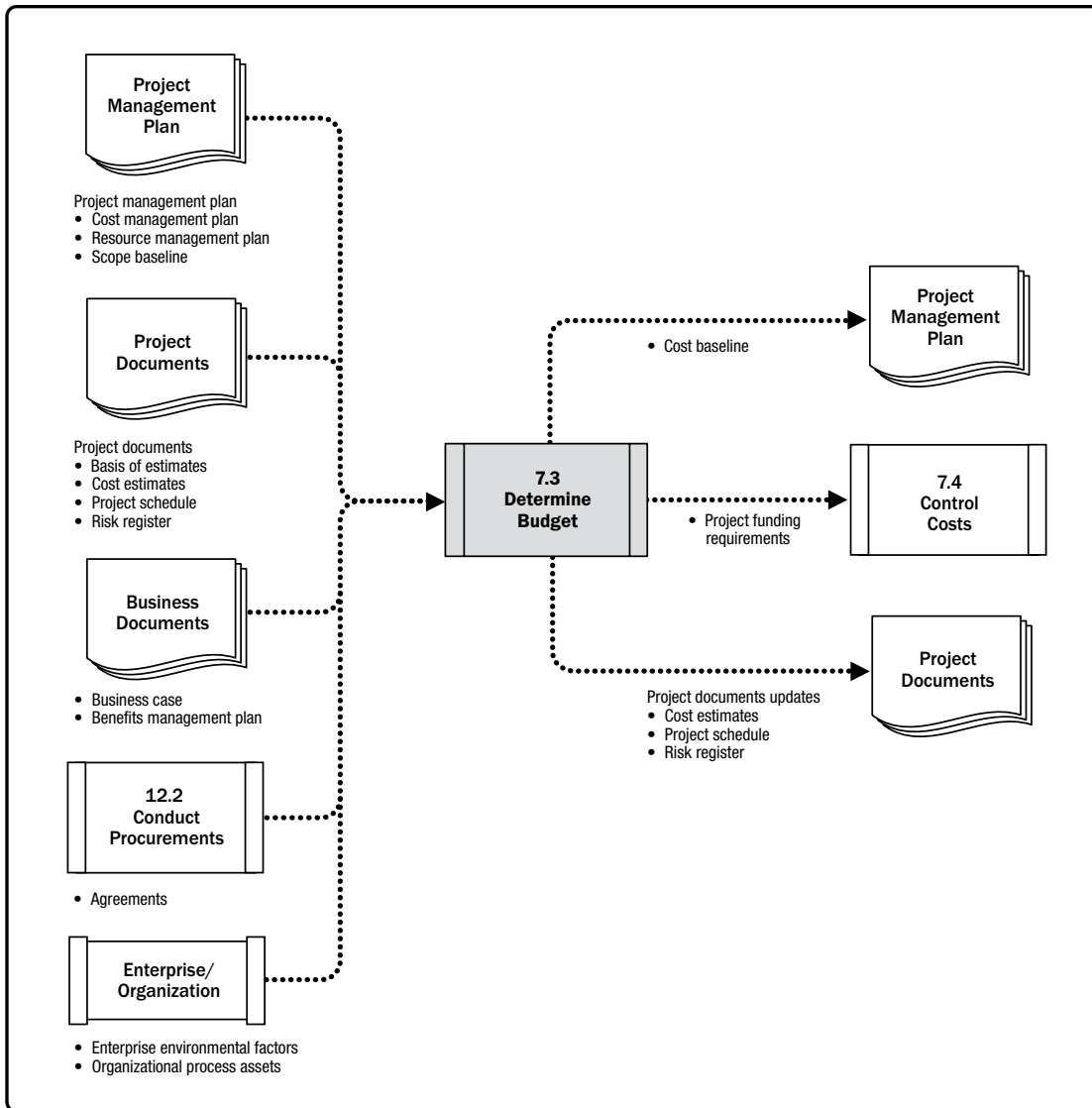

Figure 7-7. Determine Budget: Data Flow Diagram

7.3.1 DETERMINE BUDGET: INPUTS

7.3.1.1 PROJECT MANAGEMENT PLAN

Described in Section 4.2.3.1. Project management plan components include but are not limited to:

- ◆ **Cost management plan.** Described in Section 7.1.3.1. The cost management plan describes how the project costs will be structured into the project budget.
- ◆ **Resource management plan.** Described in Section 9.1.3.1. The resource management plan provides information on rates (personnel and other resources), estimation of travel costs, and other foreseen costs that are necessary to estimate the overall project budget.
- ◆ **Scope baseline.** Described in Section 5.4.3.1. The scope baseline includes the project scope statement, WBS, and WBS dictionary details for cost estimation and management.

7.3.1.2 PROJECT DOCUMENTS

Examples of project documents that can be considered as inputs for this process include but are not limited to:

- ◆ **Basis of estimates.** Described in Section 6.4.3.2. Supporting detail for cost estimates contained in the basis for estimates should specify any basic assumptions dealing with the inclusion or exclusion of indirect or other costs in the project budget.
- ◆ **Cost estimates.** Described in Section 7.2.3.1. Cost estimates for each activity within a work package are aggregated to obtain a cost estimate for each work package.
- ◆ **Project schedule.** Described in Section 6.5.3.2. The project schedule includes planned start and finish dates for the project's activities, milestones, work packages, and control accounts. This information can be used to aggregate costs to the calendar periods in which the costs are planned to be incurred.
- ◆ **Risk register.** Described in Section 11.2.3.1. The risk register should be reviewed to consider how to aggregate the risk response costs. Updates to the risk register are included with project documents updates described in Section 11.5.3.3.

7.3.1.3 BUSINESS DOCUMENTS

Described in Section 1.2.6. The business documents that can be considered as inputs for this process include but are not limited to:

- ◆ **Business case.** The business case identifies the critical success factors for the project, including financial success factors.
- ◆ **Benefits management plan.** The benefits management plan includes the target benefits, such as net present value calculations, timeframe for realizing benefits, and the metrics associated with the benefits.

7.3.1.4 AGREEMENTS

Described in Section 12.2.3.2. Applicable agreement information and costs relating to products, services, or results that have been or will be purchased are included when determining the budget.

7.3.1.5 ENTERPRISE ENVIRONMENTAL FACTORS

The enterprise environmental factors that can influence the Estimate Costs process include but are not limited to exchange rates. For large-scale projects that extend multiple years with multiple currencies, the fluctuations of currencies need to be understood and built into the Determine Budget process.

7.3.1.6 ORGANIZATIONAL PROCESS ASSETS

The organizational process assets that can influence the Determine Budget process include but are not limited to:

- ◆ Existing formal and informal cost budgeting-related policies, procedures, and guidelines;
- ◆ Historical information and lessons learned repository.
- ◆ Cost budgeting tools; and
- ◆ Reporting methods.



7.3.2 DETERMINE BUDGET: TOOLS AND TECHNIQUES

7.3.2.1 EXPERT JUDGMENT

Described in Section 4.1.2.1. Expertise should be considered from individuals or groups with specialized knowledge or training in the following topics:

- ◆ Previous similar projects;
- ◆ Information in the industry, discipline, and application area;
- ◆ Financial principles; and
- ◆ Funding requirement and sources.

7.3.2.2 COST AGGREGATION

Cost estimates are aggregated by work packages in accordance with the WBS. The work package cost estimates are then aggregated for the higher component levels of the WBS (such as control accounts) and, ultimately, for the entire project.

7.3.2.3 DATA ANALYSIS

A data analysis technique that can be used in the Determine Budget process includes but is not limited to reserve analysis, which can establish the management reserves for the project. Management reserves are an amount of the project budget withheld for management control purposes and are reserved for unforeseen work that is within scope of the project. Management reserves are intended to address the unknown unknowns that can affect a project. The management reserve is not included in the cost baseline but is part of the overall project budget and funding requirements. When an amount of management reserves is used to fund unforeseen work, the amount of management reserve used is added to the cost baseline, thus requiring an approved change to the cost baseline.

7.3.2.4 HISTORICAL INFORMATION REVIEW

Reviewing historical information can assist in developing parametric estimates or analogous estimates. Historical information may include project characteristics (parameters) to develop mathematical models to predict total project costs. Such models may be simple (e.g., residential home construction is based on a certain cost per square foot of space) or complex (e.g., one model of software development costing uses multiple separate adjustment factors, each of which has numerous points within it).

Both the cost and accuracy of analogous and parametric models can vary widely. They are most likely to be reliable when:

- ◆ Historical information used to develop the model is accurate,
- ◆ Parameters used in the model are readily quantifiable, and
- ◆ Models are scalable, such that they work for large projects, small projects, and phases of a project.

7.3.2.5 FUNDING LIMIT RECONCILIATION

The expenditure of funds should be reconciled with any funding limits on the commitment of funds for the project. A variance between the funding limits and the planned expenditures will sometimes necessitate the rescheduling of work to level out the rate of expenditures. This is accomplished by placing imposed date constraints for work into the project schedule.

7.3.2.6 FINANCING

Financing entails acquiring funding for projects. It is common for long-term infrastructure, industrial, and public services projects to seek external sources of funds. If a project is funded externally, the funding entity may have certain requirements that are required to be met.

7.3.3 DETERMINE BUDGET: OUTPUTS

7.3.3.1 COST BASELINE

The cost baseline is the approved version of the time-phased project budget, excluding any management reserves, which can only be changed through formal change control procedures. It is used as a basis for comparison to actual results. The cost baseline is developed as a summation of the approved budgets for the different schedule activities.

Figure 7-8 illustrates the various components of the project budget and cost baseline. Cost estimates for the various project activities, along with any contingency reserves (see Section 7.2.2.6) for these activities, are aggregated into their associated work package costs. The work package cost estimates, along with any contingency reserves estimated for the work packages, are aggregated into control accounts. The summation of the control accounts make up the cost baseline. Since the cost estimates that make up the cost baseline are directly tied to the schedule activities, this enables a time-phased view of the cost baseline, which is typically displayed in the form of an S-curve, as is illustrated in Figure 7-9. For projects that use earned value management, the cost baseline is referred to as the performance measurement baseline.

Management reserves (Section 7.2.2.3) are added to the cost baseline to produce the project budget. As changes warranting the use of management reserves arise, the change control process is used to obtain approval to move the applicable management reserve funds into the cost baseline.



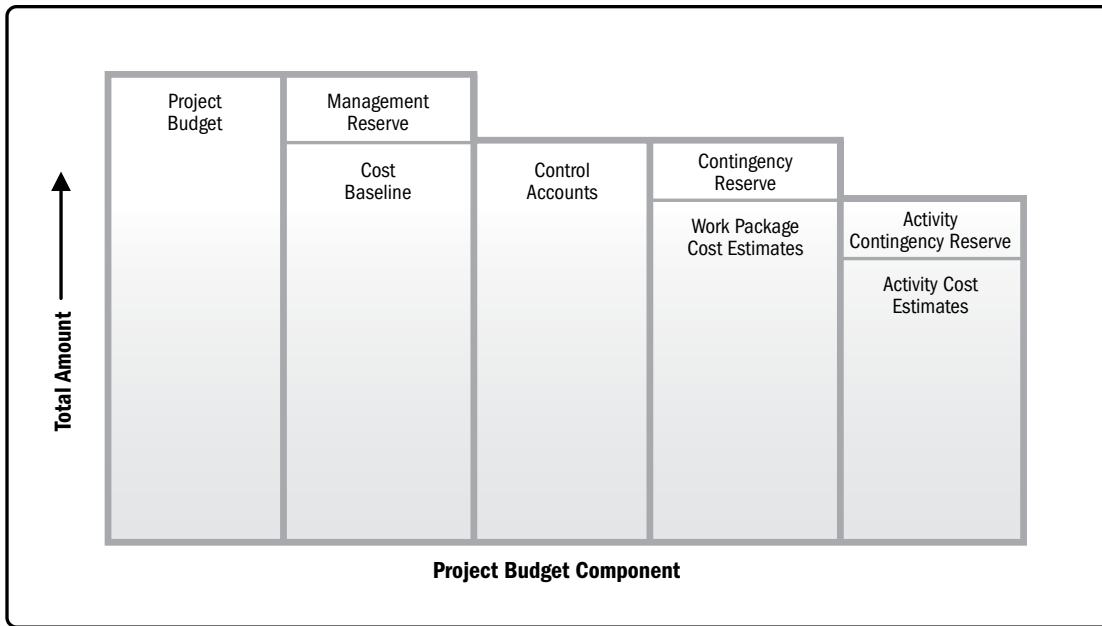

Figure 7-8. Project Budget Components

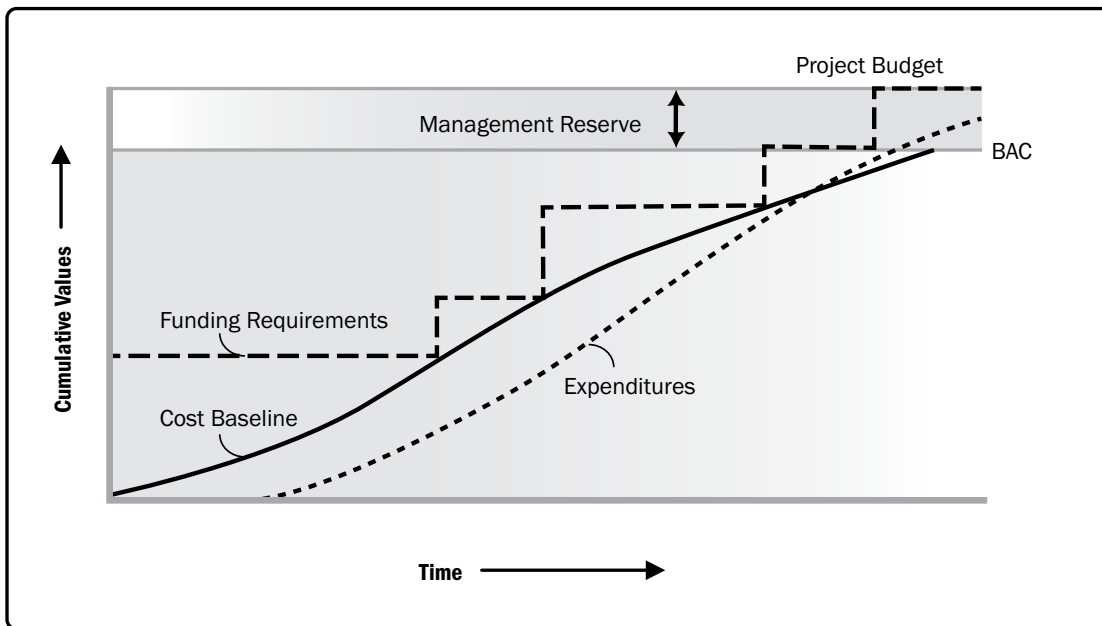

Figure 7-9. Cost Baseline, Expenditures, and Funding Requirements

7.3.3.2 PROJECT FUNDING REQUIREMENTS

Total funding requirements and periodic funding requirements (e.g., quarterly, annually) are derived from the cost baseline. The cost baseline will include projected expenditures plus anticipated liabilities. Funding often occurs in incremental amounts, and may not be evenly distributed, which appear as steps in Figure 7-9. The total funds required are those included in the cost baseline plus management reserves, if any. Funding requirements may include the source(s) of the funding.

7.3.3.3 PROJECT DOCUMENTS UPDATES

Project documents that may be updated as a result of carrying out this process include but are not limited to:

- ◆ **Cost estimates.** Described in Section 7.2.3.1. Cost estimates are updated to record any additional information.
- ◆ **Project schedule.** Described in Section 6.5.3.2. Estimated costs for each activity may be recorded as part of the project schedule.
- ◆ **Risk register.** Described in Section 11.2.3.1. New risks identified during this process are recorded in the risk register and managed using the risk management processes.

7.4 CONTROL COSTS

Control Costs is the process of monitoring the status of the project to update the project costs and managing changes to the cost baseline. The key benefit of this process is that the cost baseline is maintained throughout the project. This process is performed throughout the project. The inputs, tools and techniques, and outputs of this process are depicted in Figure 7-10. Figure 7-11 depicts the data flow diagram of the process.

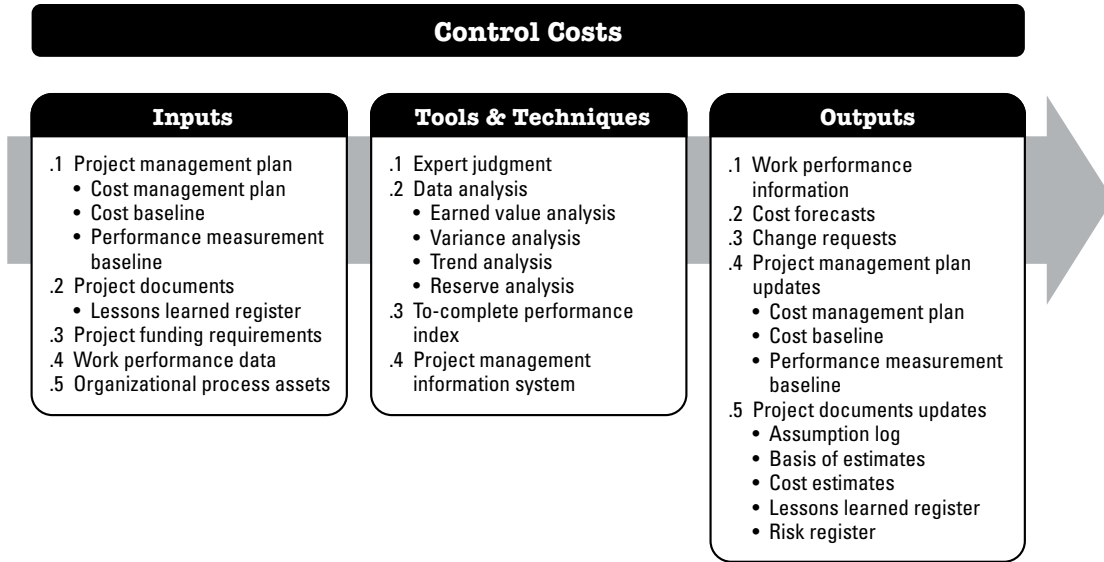

Figure 7-10. Control Costs: Inputs, Tools & Techniques, and Outputs

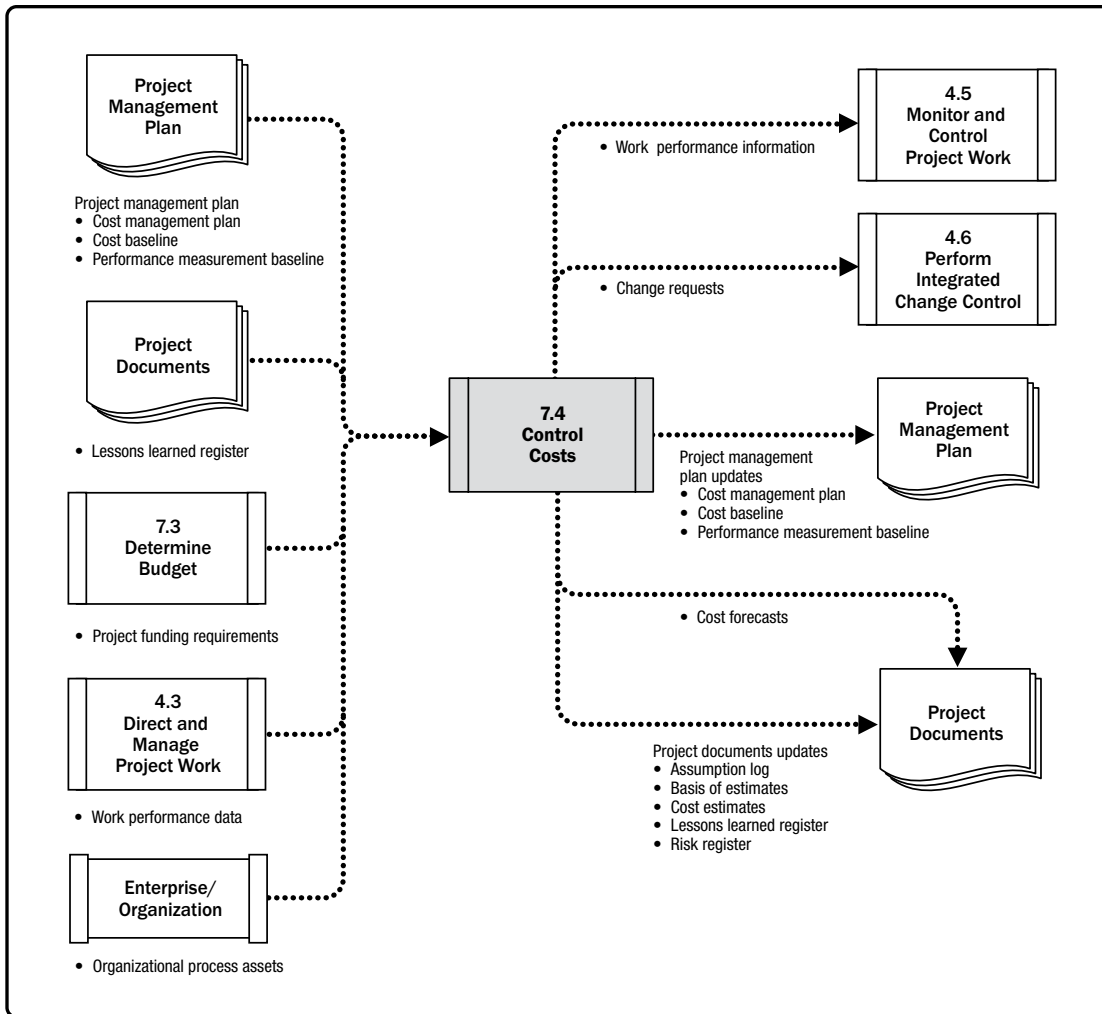

Figure 7-11. Control Costs: Data Flow Diagram

Updating the budget requires knowledge of the actual costs spent to date. Any increase to the authorized budget can only be approved through the Perform Integrated Change Control process (Section 4.6). Monitoring the expenditure of funds without regard to the value of work being accomplished for such expenditures has little value to the project, other than to track the outflow of funds. Much of the effort of cost control involves analyzing the relationship between the consumption of project funds and the work being accomplished for such expenditures. The key to effective cost control is the management of the approved cost baseline.

Project cost control includes:

- ◆ Influencing the factors that create changes to the authorized cost baseline;
- ◆ Ensuring that all change requests are acted on in a timely manner;
- ◆ Managing the actual changes when and as they occur;
- ◆ Ensuring that cost expenditures do not exceed the authorized funding by period, by WBS component, by activity, and in total for the project;
- ◆ Monitoring cost performance to isolate and understand variances from the approved cost baseline;
- ◆ Monitoring work performance against funds expended;
- ◆ Preventing unapproved changes from being included in the reported cost or resource usage;
- ◆ Informing appropriate stakeholders of all approved changes and associated cost; and
- ◆ Bringing expected cost overruns within acceptable limits.

7.4.1 CONTROL COSTS: INPUTS

7.4.1.1 PROJECT MANAGEMENT PLAN

Described in Section 4.2.3.1. Project management plan components include but are not limited to:

- ◆ **Cost management plan.** Described in Section 7.1.3.1. The cost management plan describes how the project costs will be managed and controlled.
- ◆ **Cost baseline.** Described in Section 7.3.3.1. The cost baseline is compared with actual results to determine if a change, corrective action, or preventive action is necessary.
- ◆ **Performance measurement baseline.** Described in Section 4.2.3.1. When using earned value analysis, the performance measurement baseline is compared to actual results to determine if a change, corrective action, or preventive action is necessary.

7.4.1.2. PROJECT DOCUMENTS

Examples of project documents that can be considered as inputs for this process include but are not limited to the lessons learned register. Described in Section 4.4.3.1. Lessons learned earlier in the project can be applied to later phases in the project to improve cost control.

7.4.1.3 PROJECT FUNDING REQUIREMENTS

Described in Section 7.3.3.2. The project funding requirements include projected expenditures plus anticipated liabilities.

7.4.1.4 WORK PERFORMANCE DATA

Described in Section 4.3.3.2. Work performance data contains data on project status such as which costs have been authorized, incurred, invoiced, and paid.

7.4.1.5 ORGANIZATIONAL PROCESS ASSETS

The organizational process assets that can influence the Control Costs process include but are not limited to:

- ◆ Existing formal and informal cost control-related policies, procedures, and guidelines;
- ◆ Cost control tools; and
- ◆ Monitoring and reporting methods to be used.

7.4.2 CONTROL COSTS: TOOLS AND TECHNIQUES

7.4.2.1 EXPERT JUDGMENT

Described in Section 4.1.2.1. Examples of expert judgment during the Control Costs process include but are not limited to:

- ◆ Variance analysis,
- ◆ Earned value analysis,
- ◆ Forecasting, and
- ◆ Financial analysis.

7.4.2.2 DATA ANALYSIS

Data analysis techniques that can be used to control costs include but are not limited to:

- ◆ **Earned value analysis (EVA).** Earned value analysis compares the performance measurement baseline to the actual schedule and cost performance. EVM integrates the scope baseline with the cost baseline and schedule baseline to form the performance measurement baseline. EVM develops and monitors three key dimensions for each work package and control account:
 - *Planned value.* Planned value (PV) is the authorized budget assigned to scheduled work. It is the authorized budget planned for the work to be accomplished for an activity or work breakdown structure (WBS) component, not including management reserve. This budget is allocated by phase over the life of the project, but at a given point in time, planned value defines the physical work that should have been accomplished. The total of the PV is sometimes referred to as the performance measurement baseline (PMB). The total planned value for the project is also known as budget at completion (BAC).
 - *Earned value.* Earned value (EV) is a measure of work performed expressed in terms of the budget authorized for that work. It is the budget associated with the authorized work that has been completed. The EV being measured needs to be related to the PMB, and the EV measured cannot be greater than the authorized PV budget for a component. The EV is often used to calculate the percent complete of a project. Progress measurement criteria should be established for each WBS component to measure work in progress. Project managers monitor EV, both incrementally to determine current status and cumulatively to determine the long-term performance trends.
 - *Actual cost.* Actual cost (AC) is the realized cost incurred for the work performed on an activity during a specific time period. It is the total cost incurred in accomplishing the work that the EV measured. The AC needs to correspond in definition to what was budgeted in the PV and measured in the EV (e.g., direct hours only, direct costs only, or all costs including indirect costs). The AC will have no upper limit; whatever is spent to achieve the EV will be measured.

- ◆ **Variance analysis.** Described in Section 4.5.2.2. Variance analysis, as used in EVM, is the explanation (cause, impact, and corrective actions) for cost ($CV = EV - AC$), schedule ($SV = EV - PV$), and variance at completion ($VAC = BAC - EAC$) variances. Cost and schedule variances are the most frequently analyzed measurements. For projects not using formal earned value analysis, similar variance analyses can be performed by comparing planned cost against actual cost to identify variances between the cost baseline and actual project performance. Further analysis can be performed to determine the cause and degree of variance relative to the schedule baseline and any corrective or preventive actions needed. Cost performance measurements are used to assess the magnitude of variation to the original cost baseline. An important aspect of project cost control includes determining the cause and degree of variance relative to the cost baseline (see Section 7.3.3.1) and deciding whether corrective or preventive action is required. The percentage range of acceptable variances will tend to decrease as more work is accomplished. Examples of variance analysis include but are not limited to:
 - *Schedule variance.* Schedule variance (SV) is a measure of schedule performance expressed as the difference between the earned value and the planned value. It is the amount by which the project is ahead or behind the planned delivery date, at a given point in time. It is a measure of schedule performance on a project. It is equal to the earned value (EV) minus the planned value (PV). The EVA schedule variance is a useful metric in that it can indicate when a project is falling behind or is ahead of its baseline schedule. The EVA schedule variance will ultimately equal zero when the project is completed because all of the planned values will have been earned. Schedule variance is best used in conjunction with critical path method (CPM) scheduling and risk management. Equation: $SV = EV - PV$.
 - *Cost variance.* Cost variance (CV) is the amount of budget deficit or surplus at a given point in time, expressed as the difference between earned value and the actual cost. It is a measure of cost performance on a project. It is equal to the earned value (EV) minus the actual cost (AC). The cost variance at the end of the project will be the difference between the budget at completion (BAC) and the actual amount spent. The CV is particularly critical because it indicates the relationship of physical performance to the costs spent. Negative CV is often difficult for the project to recover. Equation: $CV = EV - AC$.

- *Schedule performance index.* The schedule performance index (SPI) is a measure of schedule efficiency expressed as the ratio of earned value to planned value. It measures how efficiently the project team is accomplishing the work. It is sometimes used in conjunction with the cost performance index (CPI) to forecast the final project completion estimates. An SPI value less than 1.0 indicates less work was completed than was planned. An SPI greater than 1.0 indicates that more work was completed than was planned. Since the SPI measures all project work, the performance on the critical path also needs to be analyzed to determine whether the project will finish ahead of or behind its planned finish date. The SPI is equal to the ratio of the EV to the PV. Equation: $SPI = EV/PV$.
- *Cost performance index.* The cost performance index (CPI) is a measure of the cost efficiency of budgeted resources, expressed as a ratio of earned value to actual cost. It is considered the most critical EVA metric and measures the cost efficiency for the work completed. A CPI value of less than 1.0 indicates a cost overrun for work completed. A CPI value greater than 1.0 indicates a cost underrun of performance to date. The CPI is equal to the ratio of the EV to the AC. Equation: $CPI = EV/AC$.
- ◆ **Trend analysis.** Described in Section 4.5.2.2. Trend analysis examines project performance over time to determine if performance is improving or deteriorating. Graphical analysis techniques are valuable for understanding performance to date and for comparison to future performance goals in the form of BAC versus estimate at completion (EAC) and completion dates. Examples of the trend analysis techniques include but are not limited to:
 - *Charts.* In earned value analysis, three parameters of planned value, earned value, and actual cost can be monitored and reported on both a period-by-period basis (typically weekly or monthly) and on a cumulative basis. Figure 7-12 uses S-curves to display EV data for a project that is performing over budget and behind the schedule.

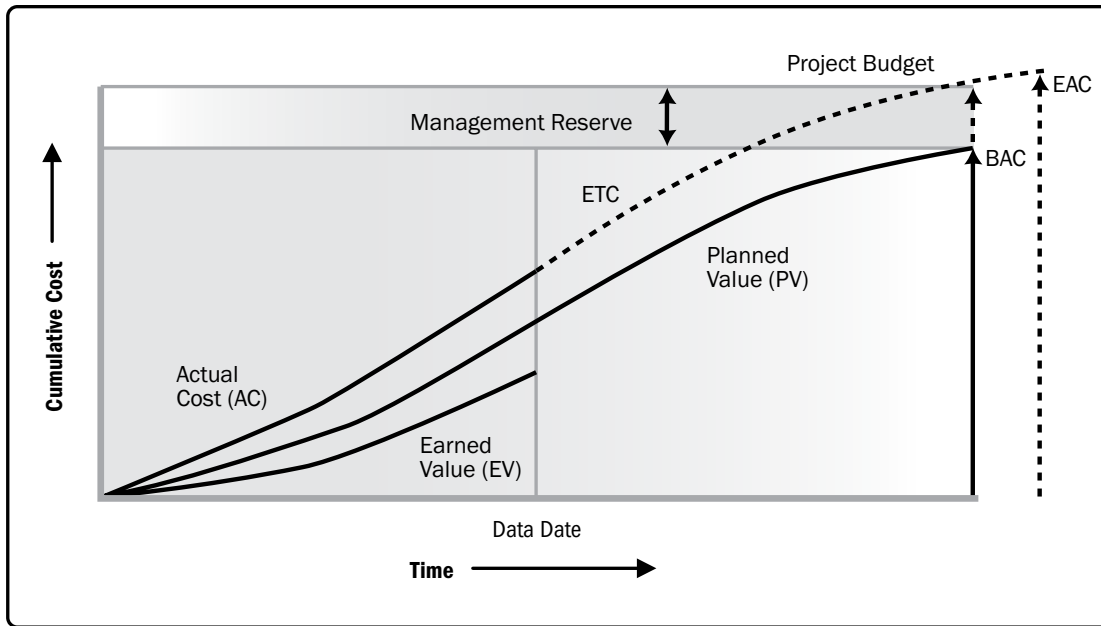

Figure 7-12. Earned Value, Planned Value, and Actual Costs

- Forecasting.** As the project progresses, the project team may develop a forecast for the estimate at completion (EAC) that may differ from the budget at completion (BAC) based on the project performance. If it becomes obvious that the BAC is no longer viable, the project manager should consider the forecasted EAC. Forecasting the EAC involves making projections of conditions and events in the project's future based on current performance information and other knowledge available at the time of the forecast. Forecasts are generated, updated, and reissued based on work performance data (Section 4.3.3.2) that is provided as the project is executed. The work performance information covers the project's past performance and any information that could impact the project in the future.

EACs are typically based on the actual costs incurred for work completed, plus an estimate to complete (ETC) the remaining work. It is incumbent on the project team to predict what it may encounter to perform the ETC, based on its experience to date. Earned value analysis works well in conjunction with manual forecasts of the required EAC costs. The most common EAC forecasting approach is a manual, bottom-up summation by the project manager and project team.

The project manager's bottom-up EAC method builds upon the actual costs and experience incurred for the work completed, and requires a new estimate to complete the remaining project work. Equation: $EAC = AC + \text{Bottom-up ETC}$.

The project manager's manual EAC is quickly compared with a range of calculated EACs representing various risk scenarios. When calculating EAC values, the cumulative CPI and SPI values are typically used. While EVM data quickly provide many statistical EACs, only three of the more common methods are described as follows:

- *EAC forecast for ETC work performed at the budgeted rate.* This EAC method accepts the actual project performance to date (whether favorable or unfavorable) as represented by the actual costs, and predicts that all future ETC work will be accomplished at the budgeted rate. When actual performance is unfavorable, the assumption that future performance will improve should be accepted only when supported by project risk analysis. Equation: $EAC = AC + (BAC - EV)$.
 - *EAC forecast for ETC work performed at the present CPI.* This method assumes that what the project has experienced to date can be expected to continue in the future. The ETC work is assumed to be performed at the same cumulative cost performance index (CPI) as that incurred by the project to date. Equation: $EAC = BAC / CPI$.
 - *EAC forecast for ETC work considering both SPI and CPI factors.* In this forecast, the ETC work will be performed at an efficiency rate that considers both the cost and schedule performance indices. This method is most useful when the project schedule is a factor impacting the ETC effort. Variations of this method weight the CPI and SPI at different values (e.g., 80/20, 50/50, or some other ratio) according to the project manager's judgment. Equation: $EAC = AC + [(BAC - EV) / (CPI \times SPI)]$.
- ◆ **Reserve analysis.** Described in Section 7.2.2.6. During cost control, reserve analysis is used to monitor the status of contingency and management reserves for the project to determine if these reserves are still needed or if additional reserves need to be requested. As work on the project progresses, these reserves may be used as planned to cover the cost of risk responses or other contingencies. Conversely, when opportunities are captured and resulting in cost savings, funds may be added to the contingency amount, or taken from the project as margin/profit.

If the identified risks do not occur, the unused contingency reserves may be removed from the project budget to free up resources for other projects or operations. Additional risk analysis during the project may reveal a need to request that additional reserves be added to the project budget.

7.4.2.3 TO-COMPLETE PERFORMANCE INDEX

The to-complete performance index (TCPI) is a measure of the cost performance that is required to be achieved with the remaining resources in order to meet a specified management goal, expressed as the ratio of the cost to finish the outstanding work to the remaining budget. TCPI is the calculated cost performance index that is achieved on the remaining work to meet a specified management goal, such as the BAC or the EAC. If it becomes obvious that the BAC is no longer viable, the project manager should consider the forecasted EAC. Once approved, the EAC may replace the BAC in the TCPI calculation. The equation for the TCPI based on the BAC: $(BAC - EV) / (BAC - AC)$.

The TCPI is conceptually displayed in Figure 7-13. The equation for the TCPI is shown in the lower left as the work remaining (defined as the BAC minus the EV) divided by the funds remaining (which can be either the BAC minus the AC, or the EAC minus the AC).

If the cumulative CPI falls below the baseline (as shown in Figure 7-13), all future work of the project will need to be performed immediately in the range of the TCPI (BAC) (as reflected in the top line of Figure 7-13) to stay within the authorized BAC. Whether this level of performance is achievable is a judgment call based on a number of considerations, including risk, time remaining in the project, and technical performance. This level of performance is displayed as the TCPI (EAC) line. The equation for the TCPI is based on the EAC: $(BAC - EV) / (EAC - AC)$. The EVM formulas are provided in Table 7-1.



Table 7-1. Earned Value Calculations Summary Table

Earned Value Analysis					
Abbreviation	Name	Lexicon Definition	How Used	Equation	Interpretation of Result
PV	Planned Value	The authorized budget assigned to scheduled work.	The value of the work planned to be completed to a point in time, usually the data date, or project completion.		
EV	Earned Value	The measure of work performed expressed in terms of the budget authorized for that work.	The planned value of all the work completed (earned) to a point in time, usually the data date, without reference to actual costs.	EV = sum of the planned value of completed work	
AC	Actual Cost	The realized cost incurred for the work performed on an activity during a specific time period.	The actual cost of all the work completed to a point in time, usually the data date.		
BAC	Budget at Completion	The sum of all budgets established for the work to be performed.	The value of total planned work, the project cost baseline.		
CV	Cost Variance	The amount of budget deficit or surplus at a given point in time, expressed as the difference between the earned value and the actual cost.	The difference between the value of work completed to a point in time, usually the data date, and the actual costs to the same point in time.	CV = EV - AC	Positive = Under planned cost Neutral = On planned cost Negative = Over planned cost
SV	Schedule Variance	The amount by which the project is ahead or behind the planned delivery date, at a given point in time, expressed as the difference between the earned value and the planned value.	The difference between the work completed to a point in time, usually the data date, and the work planned to be completed to the same point in time.	SV = EV - PV	Positive = Ahead of Schedule Neutral = On schedule Negative = Behind Schedule
VAC	Variance at Completion	A projection of the amount of budget deficit or surplus, expressed as the difference between the budget at completion and the estimate at completion.	The estimated difference in cost at the completion of the project.	VAC = BAC - EAC	Positive = Under planned cost Neutral = On planned cost Negative = Over planned cost
CPI	Cost Performance Index	A measure of the cost efficiency of budgeted resources expressed as the ratio of earned value to actual cost.	A CPI of 1.0 means the project is exactly on budget, that the work actually done so far is exactly the same as the cost so far. Other values show the percentage of how much costs are over or under the budgeted amount for work accomplished.	CPI = EV/AC	Greater than 1.0 = Under planned cost Exactly 1.0 = On planned cost Less than 1.0 = Over planned cost
SPI	Schedule Performance Index	A measure of schedule efficiency expressed as the ratio of earned value to planned value.	An SPI of 1.0 means that the project is exactly on schedule, that the work actually done so far is exactly the same as the work planned to be done so far. Other values show the percentage of how much costs are over or under the budgeted amount for work planned.	SPI = EV/PV	Greater than 1.0 = Ahead of schedule Exactly 1.0 = On schedule Less than 1.0 = Behind schedule
EAC	Estimate At Completion	The expected total cost of completing all work expressed as the sum of the actual cost to date and the estimate to complete.	If the CPI is expected to be the same for the remainder of the project, EAC can be calculated using: If future work will be accomplished at the planned rate, use: If the initial plan is no longer valid, use: If both the CPI and SPI influence the remaining work, use:	EAC = BAC/CPI EAC = AC + BAC - EV EAC = AC + Bottom-up ETC EAC = AC + [(BAC - EV)/(CPI x SPI)]	
ETC	Estimate to Complete	The expected cost to finish all the remaining project work.	Assuming work is proceeding on plan, the cost of completing the remaining authorized work can be calculated using: Reestimate the remaining work from the bottom up.	ETC = EAC - AC ETC = Reestimate	
TCPI	To Complete Performance Index	A measure of the cost performance that must be achieved with the remaining resources in order to meet a specified management goal, expressed as the ratio of the cost to finish the outstanding work to the budget available.	The efficiency that must be maintained in order to complete on plan. The efficiency that must be maintained in order to complete the current EAC.	TCPI = (BAC - EV)/(BAC - AC) TCPI = (BAC - EV)/(EAC - AC)	Greater than 1.0 = Harder to complete Exactly 1.0 = Same to complete Less than 1.0 = Easier to complete Greater than 1.0 = Harder to complete Exactly 1.0 = Same to complete Less than 1.0 = Easier to complete

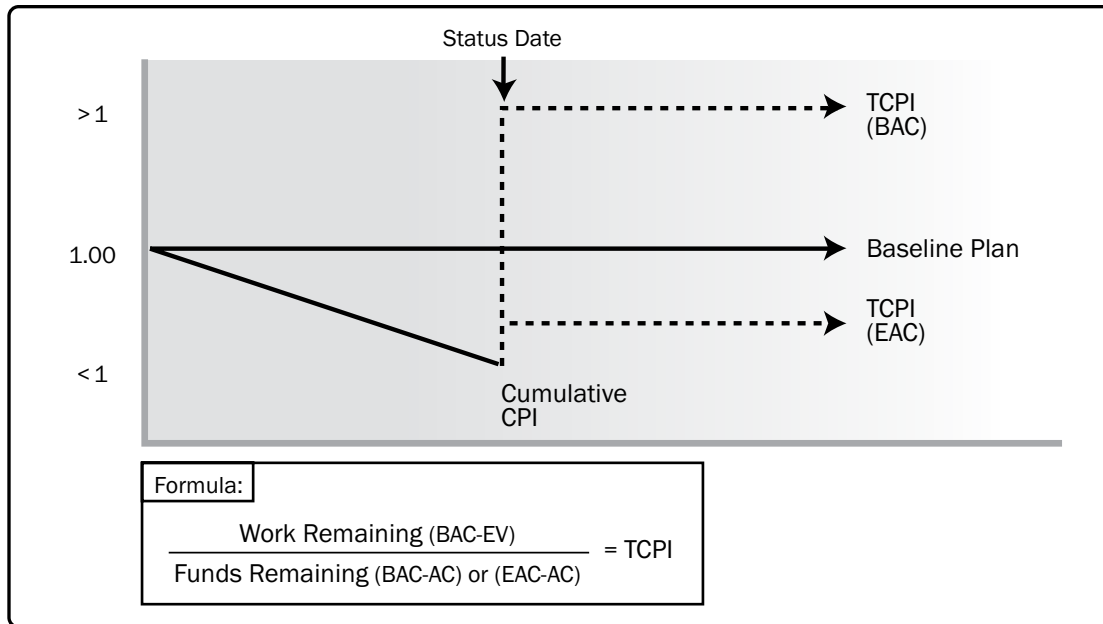

Figure 7-13. To-Complete Performance Index (TCPI)

7.4.2.4 PROJECT MANAGEMENT INFORMATION SYSTEM (PMIS)

Described in Section 4.3.2.2. Project management information systems are often used to monitor the three EVM dimensions (PV, EV, and AC), to display graphical trends, and to forecast a range of possible final project results.

7.4.3 CONTROL COSTS: OUTPUTS

7.4.3.1 WORK PERFORMANCE INFORMATION

Described in Section 4.5.1.3. Work performance information includes information on how the project work is performing compared to the cost baseline. Variances in the work performed and the cost of the work are evaluated at the work package level and control account level. For projects using earned value analysis, CV, CPI, EAC, VAC, and TCPI are documented for inclusion in work performance reports (Section 4.5.3.1).

7.4.3.2 COST FORECASTS

Either a calculated EAC value or a bottom-up EAC value is documented and communicated to stakeholders.

7.4.3.3 CHANGE REQUESTS

Described in Section 4.3.3.4. Analysis of project performance may result in a change request to the cost and schedule baselines or other components of the project management plan. Change requests are processed for review and disposition through the Perform Integrated Change Control process (Section 4.6).

7.4.3.4 PROJECT MANAGEMENT PLAN UPDATES

Any change to the project management plan goes through the organization's change control process via a change request. Components that may require a change request for the project management plan include but are not limited to:

- ◆ **Cost management plan.** Described in Section 7.1.3.1. Changes to the cost management plan, such as changes to control thresholds or specified levels of accuracy required in managing the project's cost, are incorporated in response to feedback from relevant stakeholders.
- ◆ **Cost baseline.** Described in Section 7.3.3.1. Changes to the cost baseline are incorporated in response to approved changes in scope, resources, or cost estimates. In some cases, cost variances can be so severe that a revised cost baseline is needed to provide a realistic basis for performance measurement.
- ◆ **Performance measurement baseline.** Described in Section 4.2.3.1. Changes to the performance measurement baseline are incorporated in response to approved changes in scope, schedule performance, or cost estimates. In some cases, the performance variances can be so severe that a change request is put forth to revise the performance measurement baseline to provide a realistic basis for performance measurement.



7.4.3.5 PROJECT DOCUMENTS UPDATES

Project documents that may be updated as a result of carrying out this process include but are not limited to:

- ◆ **Assumption log.** Described in Section 4.1.3.2. Cost performance may indicate the need to revise assumptions on resource productivity and other factors influencing cost performance.
- ◆ **Basis of estimates.** Described in Section 6.4.3.2. Cost performance may indicate the need to revisit the original basis of estimates.
- ◆ **Cost estimates.** Described in Section 7.2.3.1. Cost estimates may need to be updated to reflect the actual cost efficiency for the project.
- ◆ **Lessons learned register.** Described in Section 4.4.3.1. The lessons learned register can be updated with techniques that were effective in maintaining the budget, variance analysis, earned value analysis, forecasting, and corrective actions that were used to respond to cost variances.
- ◆ **Risk register.** Described in Section 11.2.3.1. The risk register may be updated if the cost variances have crossed, or are likely to cross, the cost threshold.

8

PROJECT QUALITY MANAGEMENT

Project Quality Management includes the processes for incorporating the organization's quality policy regarding planning, managing, and controlling project and product quality requirements in order to meet stakeholders' objectives. Project Quality Management also supports continuous process improvement activities as undertaken on behalf of the performing organization.

The Project Quality Management processes are:

8.1 Plan Quality Management—The process of identifying quality requirements and/or standards for the project and its deliverables, and documenting how the project will demonstrate compliance with quality requirements and/or standards.

8.2 Manage Quality—The process of translating the quality management plan into executable quality activities that incorporate the organization's quality policies into the project.

8.3 Control Quality—The process of monitoring and recording the results of executing the quality management activities to assess performance and ensure the project outputs are complete, correct, and meet customer expectations.

Figure 8-1 provides an overview of the Project Quality Management processes. The Project Quality Management processes are presented as discrete processes with defined interfaces while, in practice, they overlap and interact in ways that cannot be completely detailed in the *PMBOK® Guide*. In addition, these quality processes may differ within industries and companies.



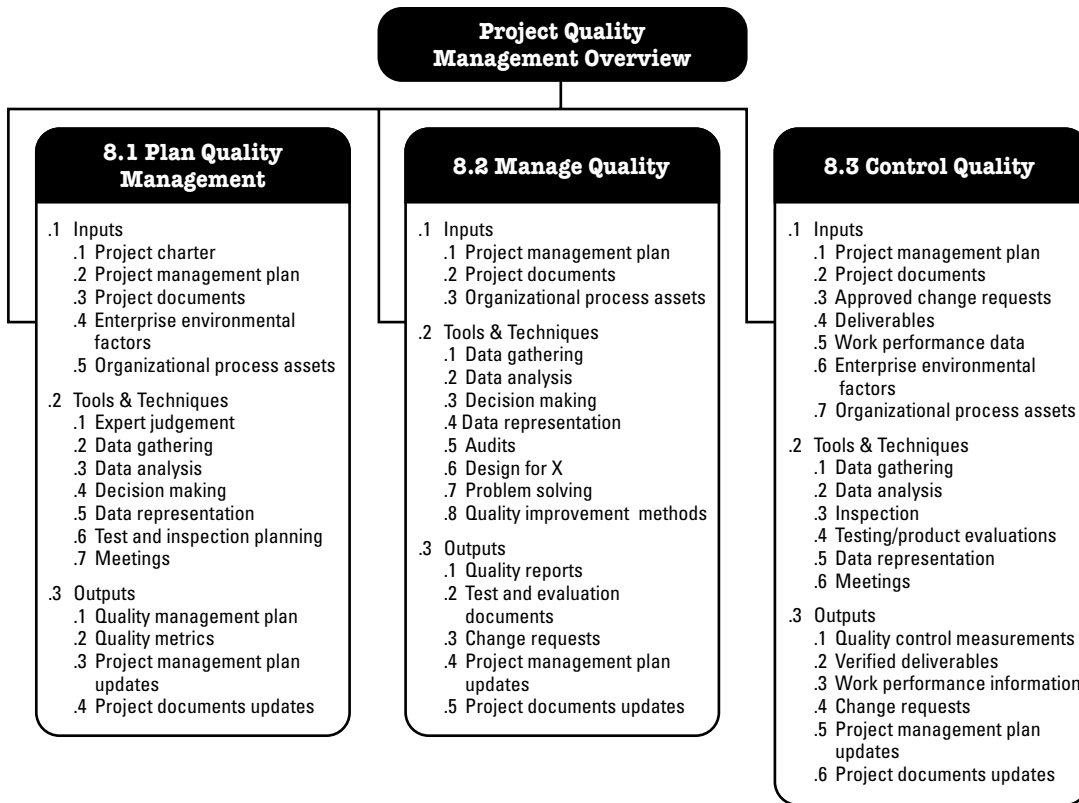

Figure 8-1. Project Quality Management Overview

Figure 8-2 provides an overview of the major inputs and outputs of the Project Quality Management processes and the interrelations of these processes in the Project Quality Management Knowledge Area. The Plan Quality Management process is concerned with the quality that the work needs to have. Manage Quality is concerned with managing the quality processes throughout the project. During the Manage Quality process, quality requirements identified during the Plan Quality Management process are turned into test and evaluation instruments, which are then applied during the Control Quality process to verify these quality requirements are met by the project. Control Quality is concerned with comparing the work results with the quality requirements to ensure the result is acceptable. There are two outputs specific to the Project Quality Management Knowledge Area that are used by other Knowledge Areas: verified deliverables and quality reports.

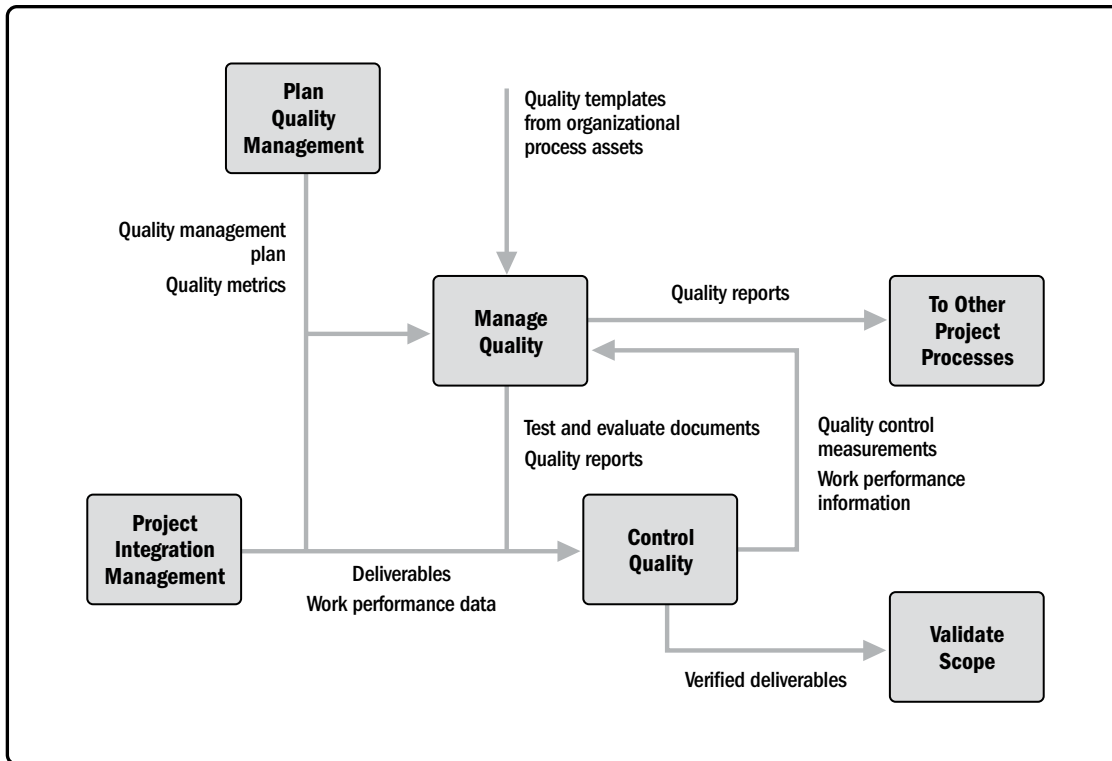

Figure 8-2. Major Project Quality Management Process Interrelations

KEY CONCEPTS FOR PROJECT QUALITY MANAGEMENT

Project Quality Management addresses the management of the project and the deliverables of the project. It applies to all projects, regardless of the nature of their deliverables. Quality measures and techniques are specific to the type of deliverables being produced by the project. For example, the project quality management of software deliverables may use different approaches and measures from those used when building a nuclear power plant. In either case, failure to meet the quality requirements can have serious negative consequences for any or all of the project's stakeholders. For example:

- ◆ Meeting customer requirements by overworking the project team may result in decreased profits and increased levels of overall project risks, employee attrition, errors, or rework.
- ◆ Meeting project schedule objectives by rushing planned quality inspections may result in undetected errors, decreased profits, and increased post-implementation risks.

Quality and *grade* are not the same concepts. Quality as a delivered performance or result is “the degree to which a set of inherent characteristics fulfill requirements” (ISO 9000 [18]). Grade as a design intent is a category assigned to deliverables having the same functional use but different technical characteristics. The project manager and the project management team are responsible for managing the trade-offs associated with delivering the required levels of both quality and grade. While a quality level that fails to meet quality requirements is always a problem, a low-grade product may not be a problem. For example:

- ◆ It may not be a problem if a suitable low-grade product (one with a limited number of features) is of high quality (no obvious defects). In this example, the product would be appropriate for its general purpose of use.
- ◆ It may be a problem if a high-grade product (one with numerous features) is of low quality (many defects). In essence, a high-grade feature set would prove ineffective and/or inefficient due to low quality.

Prevention is preferred over inspection. It is better to design quality into deliverables, rather than to find quality issues during inspection. The cost of preventing mistakes is generally much less than the cost of correcting mistakes when they are found by inspection or during usage.

Depending on the project and the industry area, the project team may need a working knowledge of statistical control processes to evaluate data contained in the Control Quality outputs. The team should know the differences between the following pairs of terms:

- ◆ *Prevention* (keeping errors out of the process) and inspection (keeping errors out of the hands of the customer);
- ◆ *Attribute sampling* (the result either conforms or does not conform) and variable sampling (the result is rated on a continuous scale that measures the degree of conformity); and
- ◆ *Tolerances* (specified range of acceptable results) and control limits (that identify the boundaries of common variation in a statistically stable process or process performance).

The cost of quality (COQ) includes all costs incurred over the life of the product by investment in preventing nonconformance to requirements, appraising the product or service for conformance to requirements, and failing to meet requirements (rework). Failure costs are often categorized into internal (found by the project team) and external (found by the customer). Failure costs are also called the cost of poor quality. Section 8.1.2.3 provides some examples to consider in each area. Organizations choose to invest in defect prevention because of the benefits over the life of the product. Because projects are temporary, decisions about the COQ over a product’s life cycle are often the concern of program management, portfolio management, the PMO, or operations.

There are five levels of increasingly effective quality management as follows:

- ◆ Usually, the most expensive approach is to let the customer find the defects. This approach can lead to warranty issues, recalls, loss of reputation, and rework costs.
- ◆ Detect and correct the defects before the deliverables are sent to the customer as part of the quality control process. The control quality process has related costs, which are mainly the appraisal costs and internal failure costs.
- ◆ Use quality assurance to examine and correct the process itself and not just special defects.
- ◆ Incorporate quality into the planning and designing of the project and product.
- ◆ Create a culture throughout the organization that is aware and committed to quality in processes and products.

TRENDS AND EMERGING PRACTICES IN PROJECT QUALITY MANAGEMENT

Modern quality management approaches seek to minimize variation and to deliver results that meet defined stakeholder requirements. Trends in Project Quality Management include but are not limited to:

- ◆ **Customer satisfaction.** Understand, evaluate, define, and manage requirements so that customer expectations are met. This requires a combination of conformance to requirements (to ensure the project produces what it was created to produce) and fitness for use (the product or service needs to satisfy the real needs). In agile environments, stakeholder engagement with the team ensures customer satisfaction is maintained throughout the project.
- ◆ **Continual improvement.** The plan-do-check-act (PDCA) cycle is the basis for quality improvement as defined by Shewhart and modified by Deming. In addition, quality improvement initiatives such as total quality management (TQM), Six Sigma, and Lean Six Sigma may improve both the quality of project management, as well as the quality of the end product, service, or result.
- ◆ **Management responsibility.** Success requires the participation of all members of the project team. Management retains, within its responsibility for quality, a related responsibility to provide suitable resources at adequate capacities.
- ◆ **Mutually beneficial partnership with suppliers.** An organization and its suppliers are interdependent. Relationships based on partnership and cooperation with the supplier are more beneficial to the organization and to the suppliers than traditional supplier management. The organization should prefer long-term relationships over short-term gains. A mutually beneficial relationship enhances the ability for both the organization and the suppliers to create value for each other, enhances the joint responses to customer needs and expectations, and optimizes costs and resources.

TAILORING CONSIDERATIONS

Each project is unique; therefore, the project manager will need to tailor the way Project Quality Management processes are applied. Considerations for tailoring include but are not limited to:

- ◆ **Policy compliance and auditing.** What quality policies and procedures exist in the organization? What quality tools, techniques, and templates are used in the organization?
- ◆ **Standards and regulatory compliance.** Are there any specific quality standards in the industry that need to be applied? Are there any specific governmental, legal, or regulatory constraints that need to be taken into consideration?
- ◆ **Continuous improvement.** How will quality improvement be managed in the project? Is it managed at the organizational level or at the level of each project?
- ◆ **Stakeholder engagement.** Is there a collaborative environment for stakeholders and suppliers?

CONSIDERATIONS FOR AGILE/ADAPTIVE ENVIRONMENTS

In order to navigate changes, agile methods call for frequent quality and review steps built in throughout the project rather than toward the end of the project.

Recurring retrospectives regularly check on the effectiveness of the quality processes. They look for the root cause of issues then suggest trials of new approaches to improve quality. Subsequent retrospectives evaluate any trial processes to determine if they are working and should be continued or new adjusting or should be dropped from use.

In order to facilitate frequent, incremental delivery, agile methods focus on small batches of work, incorporating as many elements of project deliverables as possible. Small batch systems aim to uncover inconsistencies and quality issues earlier in the project life cycle when the overall costs of change are lower.

8.1 PLAN QUALITY MANAGEMENT

Plan Quality Management is the process of identifying quality requirements and/or standards for the project and its deliverables, and documenting how the project will demonstrate compliance with quality requirements and/or standards. The key benefit of this process is that it provides guidance and direction on how quality will be managed and verified throughout the project. This process is performed once or at predefined points in the project. The inputs and outputs of this process are depicted in Figure 8.3. Figure 8.4 depicts the data flow diagram for the process.

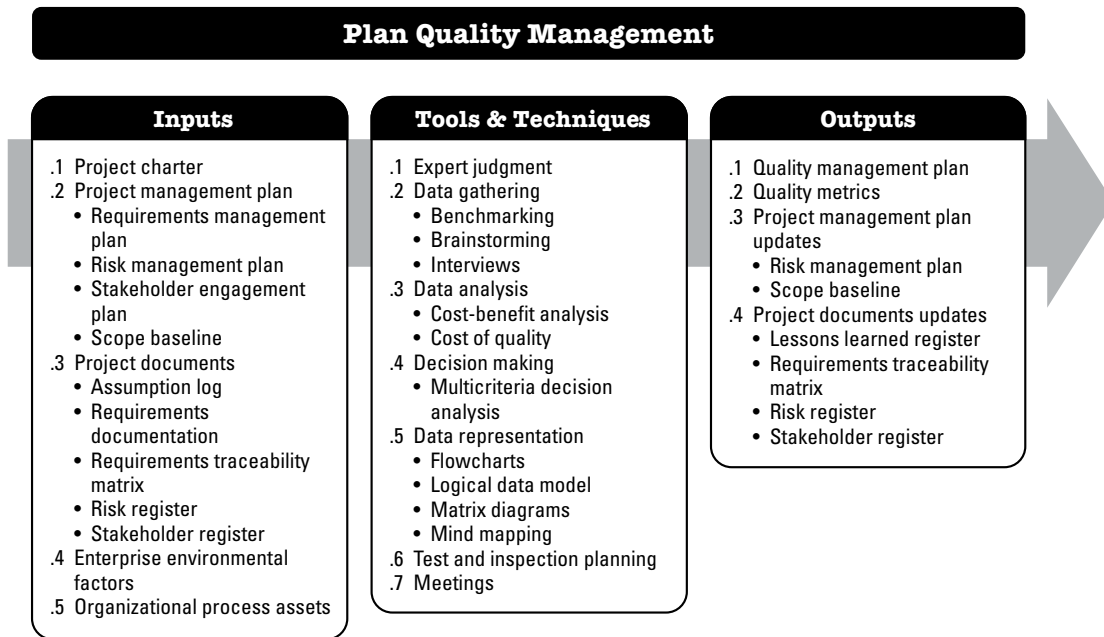

Figure 8-3. Plan Quality Management: Inputs, Tools & Techniques, and Outputs

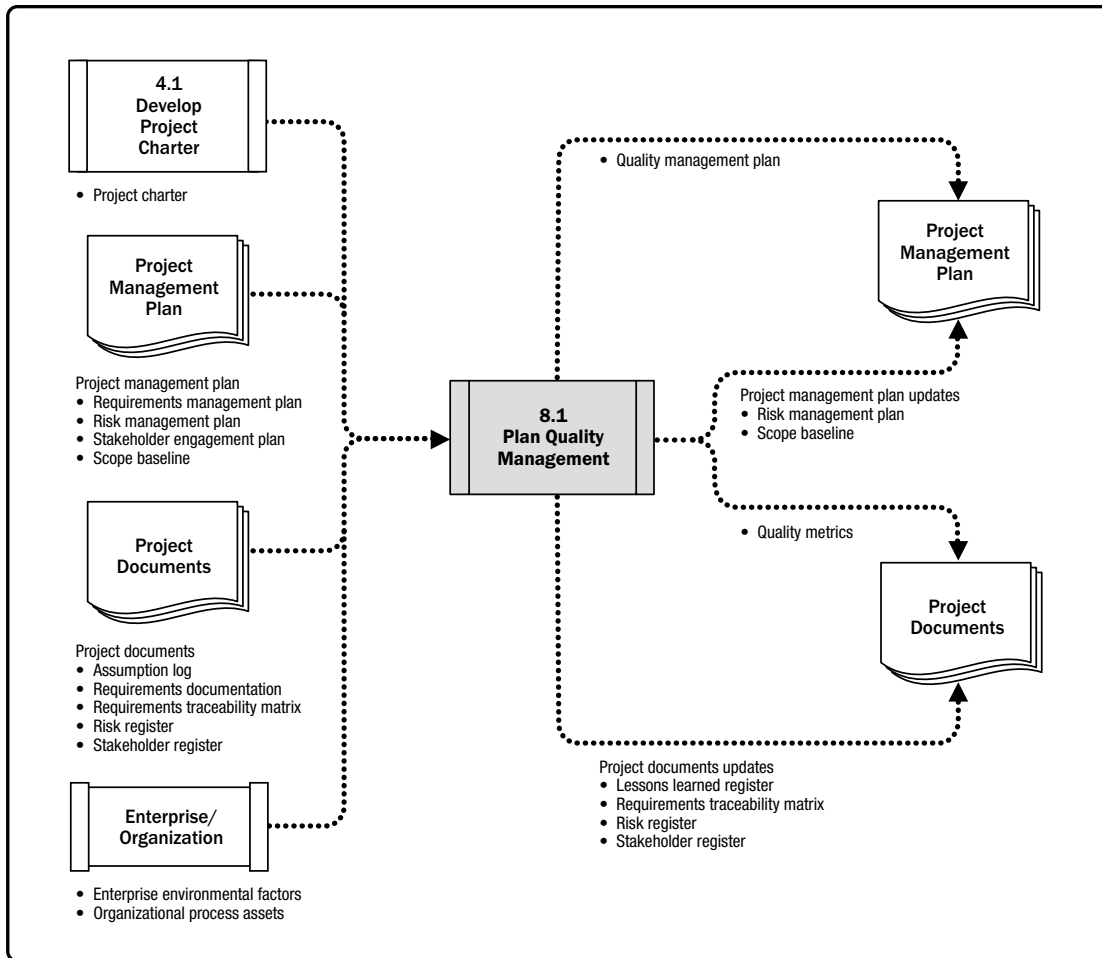

Figure 8-4. Plan Quality Management: Data Flow Diagram

Quality planning should be performed in parallel with the other planning processes. For example, changes proposed in the deliverables in order to meet identified quality standards may require cost or schedule adjustments and a detailed risk analysis of the impact to plans.

The quality planning techniques discussed here are those used most frequently on projects. There are many others that may be useful on certain projects or in specific application areas.

8.1.1 PLAN QUALITY MANAGEMENT: INPUTS

8.1.1.1 PROJECT CHARTER

Described in Section 4.1.3.1. The project charter provides the high-level project description and product characteristics. It also contains the project approval requirements, measurable project objectives, and related success criteria that will influence the quality management of the project.

8.1.1.2 PROJECT MANAGEMENT PLAN

Described in Section 4.2.3.1. Project management plan components include but are not limited to:

- ◆ **Requirements management plan.** Described in Section 5.1.3.2. The requirements management plan provides the approach for identifying, analyzing, and managing the requirements that the quality management plan and quality metrics will reference.
- ◆ **Risk management plan.** Described in Section 11.1.3.1. The risk management plan provides the approach for identifying, analyzing, and monitoring risks. The information in the risk management plan and quality management plan work together to successfully deliver product and project success.
- ◆ **Stakeholder engagement plan.** Described in Section 13.2.3.1. The stakeholder engagement plan provides the method for documenting the stakeholders' needs and expectations that provide the foundation for quality management.
- ◆ **Scope baseline.** Described in Section 5.4.3.1. The WBS along with the deliverables documented in the project scope statement are considered while determining which quality standards and objectives are suitable for the project, and which project deliverables and processes will be subjected to quality review. The scope statement includes the acceptance criteria for the deliverables. The definition of acceptance criteria may significantly increase or decrease quality costs and, therefore, project costs. Satisfying all acceptance criteria implies the needs of the stakeholders have been met.



8.1.1.3 PROJECT DOCUMENTS

Project documents that can be considered as inputs for this process include but are not limited to:

- ◆ **Assumption log.** Described in Section 4.1.3.2. The assumption log has all the assumptions and constraints regarding quality requirements and standard compliance.
- ◆ **Requirements documentation.** Described in Section 5.2.3.1. Requirements documentation captures the requirements that the project and product should attain to meet stakeholder expectations. The components of the requirements documentation include but are not limited to project and product quality requirements. Requirements are used by the project team to help plan how quality control will be implemented on the project.
- ◆ **Requirements traceability matrix.** Described in Section 5.2.3.2. The requirements traceability matrix links product requirements to deliverables and helps to ensure each requirement in the requirements documentation is tested. The matrix provides an overview of the tests required to verify the requirements.
- ◆ **Risk register.** Described in Section 11.2.3.1. The risk register contains information on threats and opportunities that may impact quality requirements.
- ◆ **Stakeholder register.** Described in Section 13.1.3.1. The stakeholder register helps to identify stakeholders who have a particular interest in or impact on quality, with the emphasis on the customer and project sponsor needs and expectations.

8.1.1.4 ENTERPRISE ENVIRONMENTAL FACTORS

The enterprise environmental factors that can influence the Plan Quality Management process include but are not limited to:

- ◆ Governmental agency regulations;
- ◆ Rules, standards, and guidelines specific to the application area;
- ◆ Geographic distribution;
- ◆ Organizational structure;
- ◆ Marketplace conditions;
- ◆ Working or operating conditions of the project or its deliverables; and
- ◆ Cultural perceptions.

8.1.1.5 ORGANIZATIONAL PROCESS ASSETS

The organizational process assets that can influence the Plan Quality Management process include but are not limited to:

- ◆ Organizational quality management system including policies, procedures, and guidelines;
- ◆ Quality templates such as check sheets, traceability matrix, and others; and
- ◆ Historical databases and lessons learned repository.

8.1.2 PLAN QUALITY MANAGEMENT: TOOLS AND TECHNIQUES

8.1.2.1 EXPERT JUDGMENT

Described in Section 4.1.2.1. Expertise should be considered from individuals or groups with specialized knowledge or training in the following topics:

- ◆ Quality assurance,
- ◆ Quality control,
- ◆ Quality measurements,
- ◆ Quality improvements, and
- ◆ Quality systems.

8.1.2.2 DATA GATHERING

Data-gathering techniques that can be used for this process include but are not limited to:

- ◆ **Benchmarking.** Benchmarking involves comparing actual or planned project practices or the project's quality standards to those of comparable projects to identify best practices, generate ideas for improvement, and provide a basis for measuring performance. Benchmarked projects may exist within the performing organization or outside of it, or can be within the same application area or other application area. Benchmarking allows for analogies from projects in a different application area or different industries to be made.
- ◆ **Brainstorming.** Described in Section 4.1.2.2. Brainstorming can be used to gather data creatively from a group of team members or subject matter experts to develop the quality management plan that best fits the upcoming project.

- ◆ **Interviews.** Described in Section 5.2.2.2. Project and product quality needs and expectations, implicit and explicit, formal and informal, can be identified by interviewing experienced project participants, stakeholders, and subject matter experts. Interviews should be conducted in an environment of trust and confidentiality to encourage honest and unbiased contributions.

8.1.2.3 DATA ANALYSIS

Data analysis techniques that can be used for this process include but are not limited to:

- ◆ **Cost-benefit analysis.** A cost-benefit analysis is a financial analysis tool used to estimate the strengths and weaknesses of alternatives in order to determine the best alternative in terms of benefits provided. A cost-benefit analysis will help the project manager determine if the planned quality activities are cost effective. The primary benefits of meeting quality requirements include less rework, higher productivity, lower costs, increased stakeholder satisfaction, and increased profitability. A cost-benefit analysis for each quality activity compares the cost of the quality step to the expected benefit.
- ◆ **Cost of quality.** The cost of quality (COQ) associated with a project consists of one or more of the following costs (Figure 8-5 lists examples for each cost group):
 - *Prevention costs.* Costs related to the prevention of poor quality in the products, deliverables, or services of the specific project.
 - *Appraisal costs.* Costs related to evaluating, measuring, auditing, and testing the products, deliverables, or services of the specific project.
 - *Failure costs (internal/external).* Costs related to nonconformance of the products, deliverables, or services to the needs or expectations of the stakeholders.

The optimal COQ is one that reflects the appropriate balance for investing in the cost of prevention and appraisal to avoid failure costs. Models show that there is an optimal quality cost for projects, where investing in additional prevention/appraisal costs is neither beneficial nor cost effective.

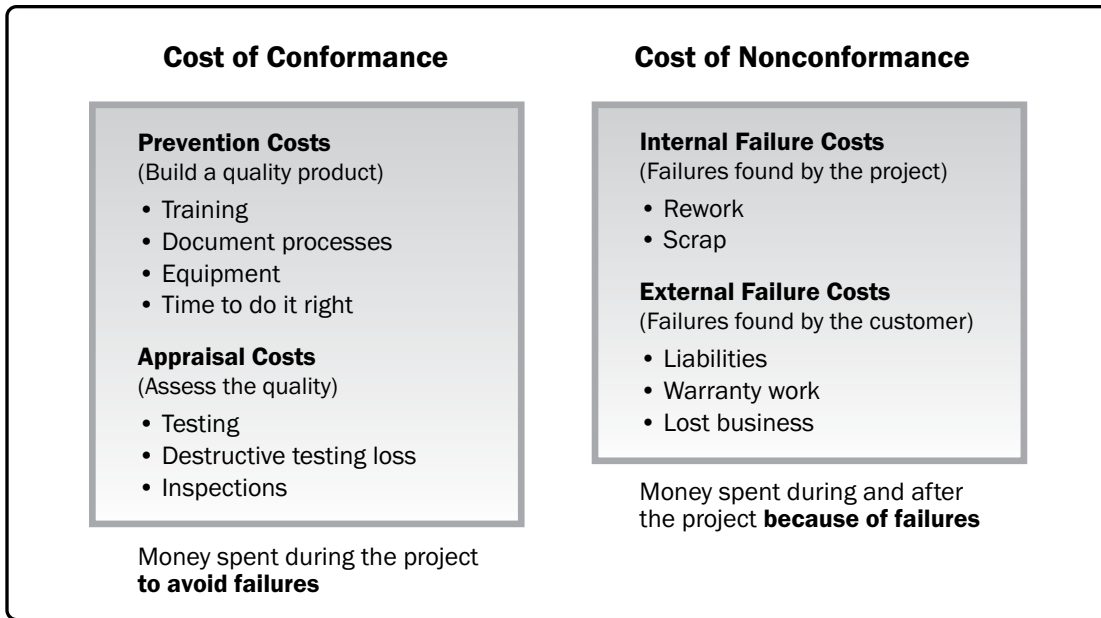

Figure 8-5. Cost of Quality

8.1.2.4 DECISION MAKING

A decision-making technique that can be used for this process includes but is not limited to multicriteria decision analysis. Multicriteria decision analysis tools (e.g., prioritization matrix) can be used to identify the key issues and suitable alternatives to be prioritized as a set of decisions for implementation. Criteria are prioritized and weighted before being applied to all available alternatives to obtain a mathematical score for each alternative. The alternatives are then ranked by score. As used in this process, it can help prioritize quality metrics.



8.1.2.5 DATA REPRESENTATION

Data representation techniques that can be used for this process include but are not limited to:

- ◆ **Flowcharts.** Flowcharts are also referred to as process maps because they display the sequence of steps and the branching possibilities that exist for a process that transforms one or more inputs into one or more outputs. Flowcharts show the activities, decision points, branching loops, parallel paths, and the overall order of processing by mapping the operational details of procedures that exist within a horizontal value chain. One version of a value chain, known as a SIPOC (suppliers, inputs, process, outputs, and customers) model, is shown in Figure 8-6. Flowcharts may prove useful in understanding and estimating the cost of quality for a process. Information is obtained by using the workflow branching logic and associated relative frequencies to estimate the expected monetary value for the conformance and nonconformance work required to deliver the expected conforming output. When flowcharts are used to represent the steps in a process, they are sometimes called process flows or process flow diagrams and they can be used for process improvement as well as identifying where quality defects can occur or where to incorporate quality checks.
- ◆ **Logical data model.** Logical data models are a visual representation of an organization's data, described in business language and independent of any specific technology. The logical data model can be used to identify where data integrity or other quality issues can arise.
- ◆ **Matrix diagrams.** Matrix diagrams help find the strength of relationships among different factors, causes, and objectives that exist between the rows and columns that form the matrix. Depending on how many factors may be compared, the project manager can use different shapes of matrix diagrams; for example, L, T, Y, X, C, and roof-shaped. In this process they facilitate identifying the key quality metrics that are important for the success of the project.
- ◆ **Mind mapping.** Described in Section 5.2.2.3. Mind mapping is a diagrammatic method used to visually organizing information. A mind map in quality is often created around a single quality concept, drawn as an image in the center of a blank landscape page, to which associated representations of ideas such as images, words, and parts of words are added. The mind-mapping technique may help in the rapid gathering of project quality requirements, constraints, dependencies, and relationships.

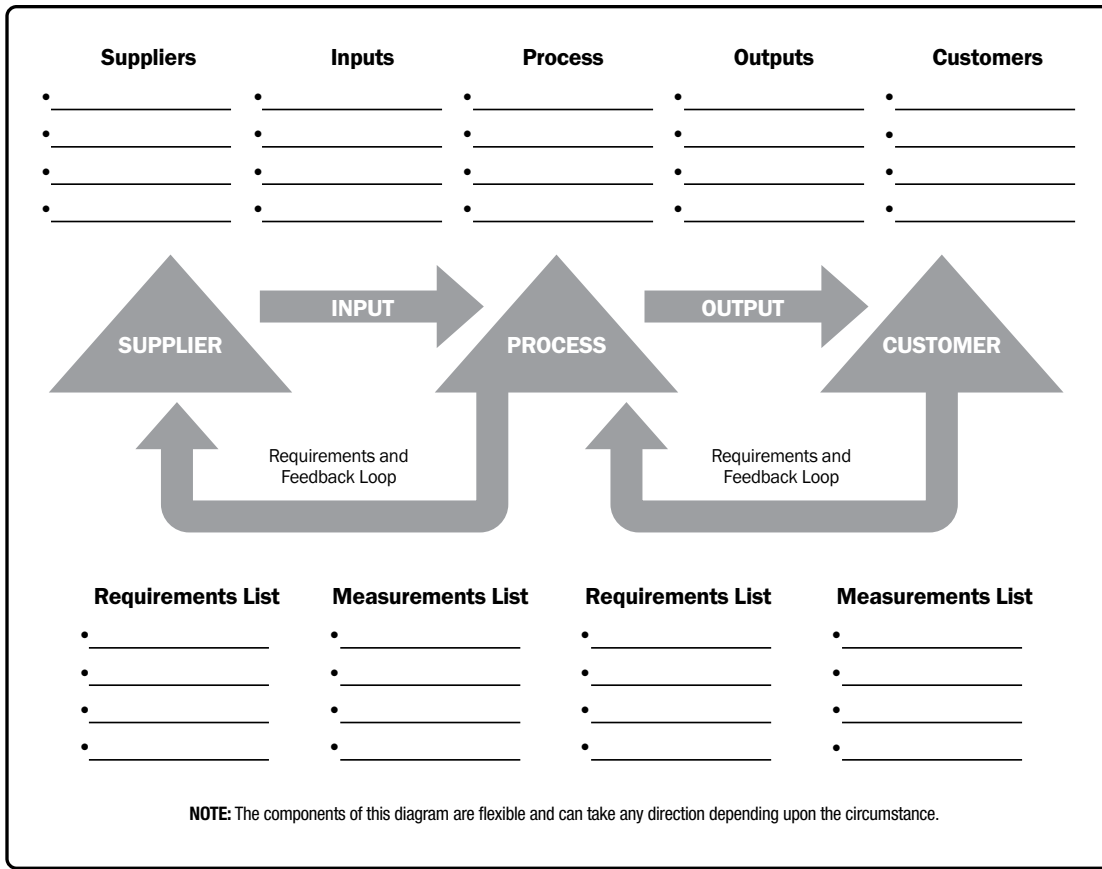

Figure 8-6. The SIPOC Model

8.1.2.6 TEST AND INSPECTION PLANNING

During the planning phase, the project manager and the project team determine how to test or inspect the product, deliverable, or service to meet the stakeholders' needs and expectations, as well as how to meet the goal for the product's performance and reliability. The tests and inspections are industry dependent and can include, for example, alpha and beta tests in software projects, strength tests in construction projects, inspection in manufacturing, and field tests and nondestructive tests in engineering.

8.1.2.7 MEETINGS

Project teams may hold planning meetings to develop the quality management plan. Attendees can include the project manager, the project sponsor, selected project team members, selected stakeholders, anyone with responsibility for project quality management activities, and others as needed.

8.1.3 PLAN QUALITY MANAGEMENT: OUTPUTS

8.1.3.1 QUALITY MANAGEMENT PLAN

The quality management plan is a component of the project management plan that describes how applicable policies, procedures, and guidelines will be implemented to achieve the quality objectives. It describes the activities and resources necessary for the project management team to achieve the quality objectives set for the project. The quality management plan may be formal or informal, detailed, or broadly framed. The style and detail of the quality management plan are determined by the requirements of the project. The quality management plan should be reviewed early in the project to ensure that decisions are based on accurate information. The benefits of this review can include a sharper focus on the project's value proposition, reductions in costs, and less frequent schedule overruns that are caused by rework.

The quality management plan may include but is not limited to the following components:

- ◆ Quality standards that will be used by the project;
- ◆ Quality objectives of the project;
- ◆ Quality roles and responsibilities;
- ◆ Project deliverables and processes subject to quality review;
- ◆ Quality control and quality management activities planned for the project;
- ◆ Quality tools that will be used for the project; and
- ◆ Major procedures relevant for the project, such as dealing with nonconformance, corrective actions procedures, and continuous improvement procedures.

8.1.3.2 QUALITY METRICS

A quality metric specifically describes a project or product attribute and how the Control Quality process will verify compliance to it. Some examples of quality metrics include percentage of tasks completed on time, cost performance measured by CPI, failure rate, number of defects identified per day, total downtime per month, errors found per line of code, customer satisfaction scores, and percentage of requirements covered by the test plan as a measure of test coverage.

8.1.3.3 PROJECT MANAGEMENT PLAN UPDATES

Any change to the project management plan goes through the organization's change control process via a change request. Components that may require a change request for the project management plan include but are not limited to:

- ◆ **Risk management plan.** Described in Section 11.1.3.1. Decisions on the quality management approach may require changes to the agreed-upon approach to managing risk on the project, and these will be recorded in the risk management plan.
- ◆ **Scope baseline.** Described in Section 5.4.3.1. The scope baseline may change as a result of this process if specific quality management activities need to be added. The WBS dictionary also records quality requirements, which may need updating.

8.1.3.4 PROJECT DOCUMENTS UPDATES

Project documents that may be updated as a result of carrying out this process include but are not limited to:

- ◆ **Lessons learned register.** Described in Section 4.4.3.1. The lessons learned register is updated with information on challenges encountered in the quality planning process.
- ◆ **Requirements traceability matrix.** Described in Section 5.2.3.2. Where quality requirements are specified by this process, they are recorded in the requirements traceability matrix.
- ◆ **Risk register.** Described in Section 11.2.3.1. New risks identified during this process are recorded in the risk register and managed using the risk management processes.
- ◆ **Stakeholder register.** Described in Section 13.1.3.1. Where additional information on existing or new stakeholders is gathered as a result of this process, it is recorded in the stakeholder register.

8.2 MANAGE QUALITY

Manage Quality is the process of translating the quality management plan into executable quality activities that incorporate the organization’s quality policies into the project. The key benefits of this process are that it increases the probability of meeting the quality objectives as well as identifying ineffective processes and causes of poor quality. Manage Quality uses the data and results from the control quality process to reflect the overall quality status of the project to the stakeholders. This process is performed throughout the project.

The inputs, tools and techniques, and outputs of this process are depicted in Figure 8-7. Figure 8-8 depicts the data flow diagram of the process.

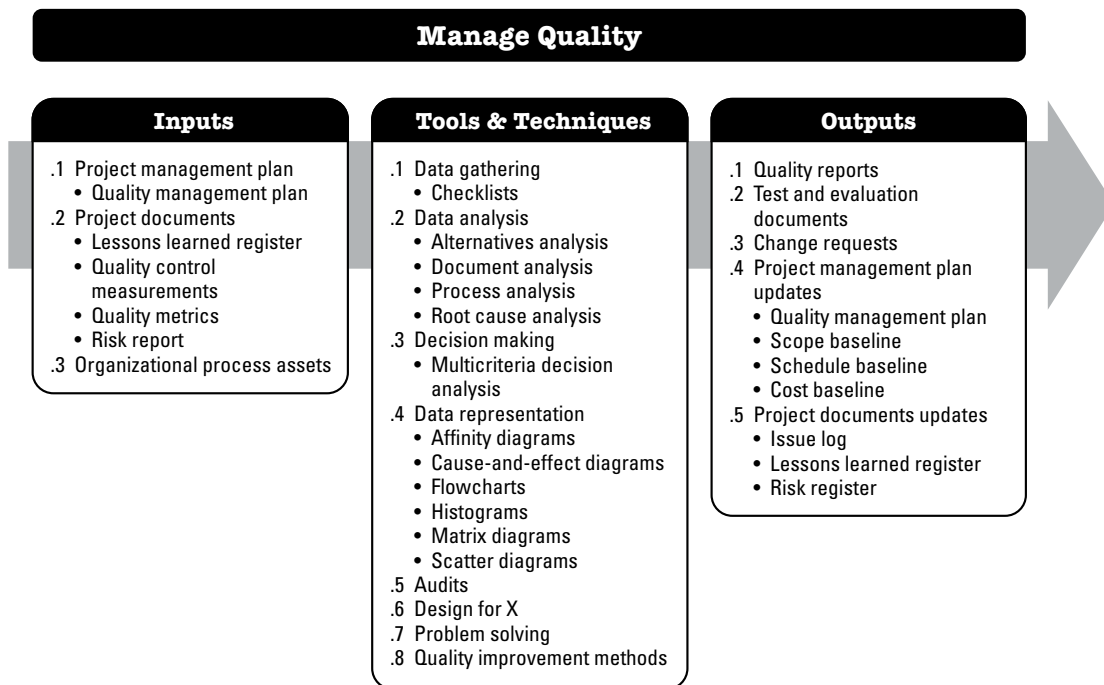

Figure 8-7. Manage Quality: Inputs, Tools & Techniques, and Outputs

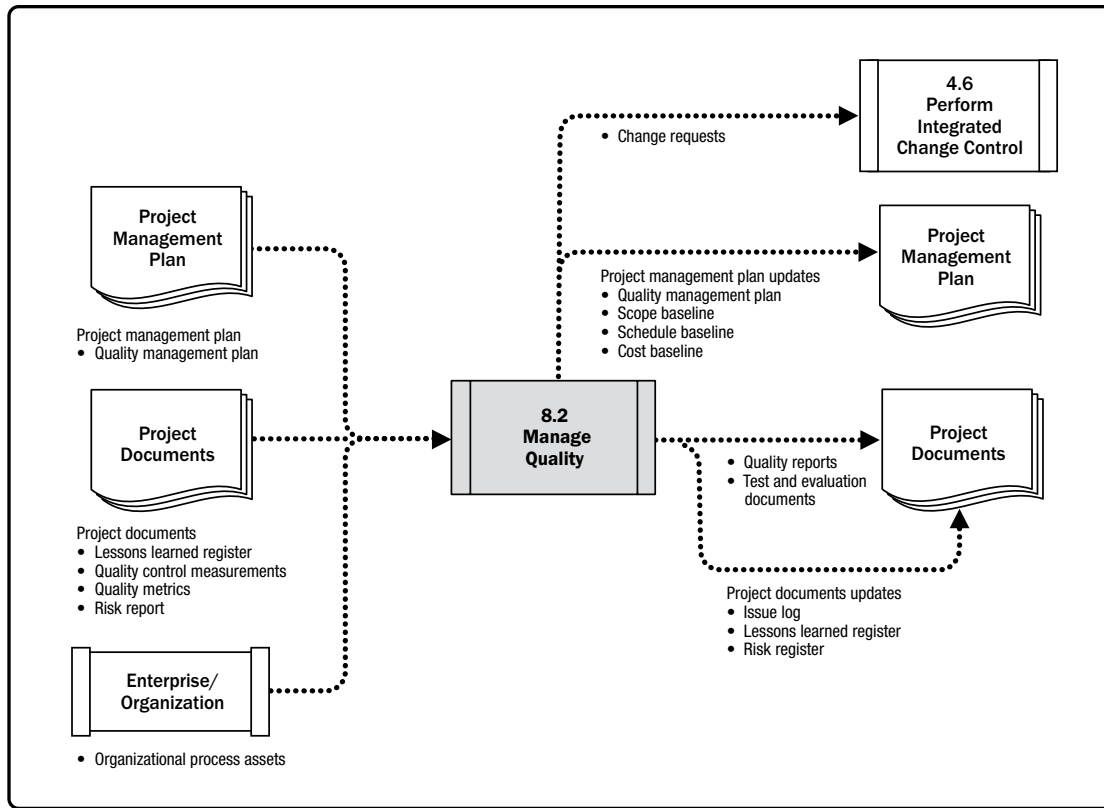

Figure 8-8. Manage Quality: Data Flow Diagram

Manage Quality is sometimes called quality assurance, although Manage Quality has a broader definition than quality assurance as it is used in nonproject work. In project management, the focus of quality assurance is on the processes used in the project. Quality assurance is about using project processes effectively. It involves following and meeting standards to assure stakeholders that the final product will meet their needs, expectations, and requirements. Manage Quality includes all the quality assurance activities, and is also concerned with the product design aspects and process improvements. Manage Quality work will fall under the conformance work category in the cost of quality framework.

The Manage Quality process implements a set of planned and systematic acts and processes defined within the project's quality management plan that helps to:

- ◆ Design an optimal and mature product by implementing specific design guidelines that address specific aspects of the product,
- ◆ Build confidence that a future output will be completed in a manner that meets the specified requirements and expectations through quality assurance tools and techniques such as quality audits and failure analysis,
- ◆ Confirm that the quality processes are used and that their use meets the quality objectives of the project, and
- ◆ Improve the efficiency and effectiveness of processes and activities to achieve better results and performance and enhance stakeholders' satisfaction.

The project manager and project team may use the organization's quality assurance department, or other organizational functions, to execute some of the Manage Quality activities such as failure analysis, design of experiments, and quality improvement. Quality assurance departments usually have cross-organizational experience in using quality tools and techniques and are a good resource for the project.

Manage Quality is considered the work of everybody—the project manager, the project team, the project sponsor, the management of the performing organization, and even the customer. All of these have roles in managing quality in the project, though the roles differ in size and effort. The level of participation in the quality management effort may differ between industries and project management styles. In agile projects, quality management is performed by all team members throughout the project, but in traditional projects, quality management is often the responsibility of specific team members.

8.2.1 MANAGE QUALITY: INPUTS

8.2.1.1 PROJECT MANAGEMENT PLAN

Described in Section 4.2.3.1. Project management plan components include but are not limited to the quality management plan. Described in Section 8.1.3.1, the quality management plan defines the acceptable level of project and product quality and describes how to ensure this level of quality in its deliverables and processes. The quality management plan also describes what to do with nonconforming products and what corrective action to implement.

8.2.1.2 PROJECT DOCUMENTS

Project documents that can be considered as inputs for this process include but are not limited to:

- ◆ **Lessons learned register.** Described in Section 4.4.3.1. Lessons learned earlier in the project with regard to managing quality can be applied to later phases in the project to improve the efficiency and effectiveness of managing quality.
- ◆ **Quality control measurements.** Described in Section 8.3.3.1. Quality control measurements are used to analyze and evaluate the quality of the processes and deliverables of the project against the standards of the performing organization or the requirements specified. Quality control measurements can also compare the processes used to create the measurements and validate actual measurements to determine their level of correctness.
- ◆ **Quality metrics.** Described in Section 8.1.3.2. Quality metrics are verified as part of the Control Quality process. The Manage Quality process uses these quality metrics as a basis for the development of test scenarios for the project and its deliverables and as a basis for improvement initiatives.
- ◆ **Risk report.** Described in Section 11.2.3.2. Risk report is used in the Manage Quality process to identify sources of overall project risk and the most important drivers of overall risk exposure that can impact the quality objectives of the project.

8.2.1.3 ORGANIZATIONAL PROCESS ASSETS

The organizational process assets that can influence the Manage Quality process include but are not limited to:

- ◆ Organizational quality management system that includes policies, procedures, and guidelines;
- ◆ Quality templates such as check sheets, traceability matrix, test plans, test documents, and others;
- ◆ Results from previous audits; and
- ◆ Lessons learned repository with information from similar projects.

8.2.2 MANAGE QUALITY: TOOLS AND TECHNIQUES

8.2.2.1 DATA GATHERING

A data-gathering technique that can be used for this process includes but is not limited to checklists (see Section 11.2.2.2). A checklist is a structured tool, usually component-specific, used to verify that a set of required steps has been performed or to check if a list of requirements has been satisfied. Based on the project's requirements and practices, checklists may be simple or complex. Many organizations have standardized checklists available to ensure consistency in frequently performed tasks. In some application areas, checklists are also available from professional associations or commercial service providers. Quality checklists should incorporate the acceptance criteria included in the scope baseline.

8.2.2.2 DATA ANALYSIS

Data analysis techniques that can be used for this process include but are not limited to:

- ◆ **Alternatives analysis.** Described in Section 9.2.2.5. This technique is used to evaluate identified options in order to select which different quality options or approaches are most appropriate to use.
- ◆ **Document analysis.** Described in Section 5.2.2.3. The analysis of different documents produced as part of the output of project control processes, such as quality reports, test reports, performance reports, and variance analysis, can point to and focus on processes that may be out of control and may jeopardize meeting the specified requirements or stakeholders' expectations.
- ◆ **Process analysis.** Process analysis identifies opportunities for process improvements. This analysis also examines problems, constraints, and non-value-added activities that occur during a process.
- ◆ **Root cause analysis (RCA).** Root cause analysis is an analytical technique used to determine the basic underlying reason that causes a variance, defect, or risk. A root cause may underlie more than one variance, defect, or risk. It may also be used as a technique for identifying root causes of a problem and solving them. When all root causes for a problem are removed, the problem does not recur.

8.2.2.3 DECISION MAKING

A decision-making technique that can be used for this process includes but is not limited to multicriteria decision analysis. Described in Section 8.1.2.4. Multicriteria decision making is used to evaluate several criteria when discussing alternatives that impact project or product quality. *Project* decisions can include choosing among different implementation scenarios or suppliers. *Product* decisions can include evaluating the life cycle cost, schedule, stakeholder satisfaction, and risks associated with resolving product defects.

8.2.2.4 DATA REPRESENTATION

Data representation techniques that can be used for this process include but are not limited to:

- ◆ **Affinity diagrams.** Described in Section 5.2.2.5. Affinity diagrams can organize potential causes of defects into groups showing areas that should be focused on the most.
- ◆ **Cause-and-effect diagrams.** Cause-and-effect diagrams are also known as fishbone diagrams, why-why diagrams, or Ishikawa diagrams. This type of diagram breaks down the causes of the problem statement identified into discrete branches, helping to identify the main or root cause of the problem. Figure 8-9 is an example of a cause-and-effect diagram.
- ◆ **Flowcharts.** Described in Section 8.1.2.5. Flowcharts show a series of steps that lead to a defect.
- ◆ **Histograms.** Histograms show a graphical representation of numerical data. Histograms can show the number of defects per deliverable, a ranking of the cause of defects, the number of times each process is noncompliant, or other representations of project or product defects.
- ◆ **Matrix diagrams.** Described in Section 8.1.2.5. The matrix diagram seeks to show the strength of relationships among factors, causes, and objectives that exist between the rows and columns that form the matrix.
- ◆ **Scatter diagrams.** A scatter diagram is a graph that shows the relationship between two variables. Scatter diagrams can demonstrate a relationship between any element of a process, environment, or activity on one axis and a quality defect on the other axis.

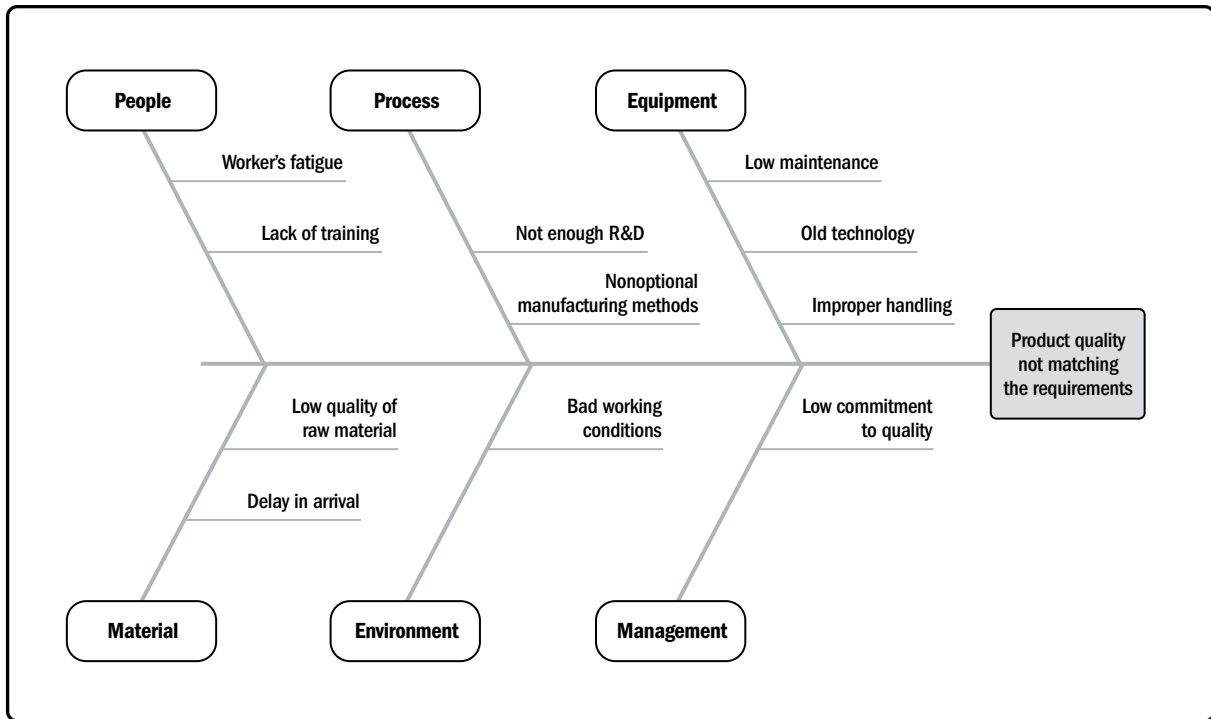

Figure 8-9. Cause-and-Effect Diagram

8.2.2.5 AUDITS

An audit is a structured, independent process used to determine if project activities comply with organizational and project policies, processes, and procedures. A quality audit is usually conducted by a team external to the project, such as the organization's internal audit department, PMO, or by an auditor external to the organization. Quality audit objectives may include but are not limited to:

- ◆ Identifying all good and best practices being implemented;
- ◆ Identifying all nonconformity, gaps, and shortcomings;
- ◆ Sharing good practices introduced or implemented in similar projects in the organization and/or industry;
- ◆ Proactively offering assistance in a positive manner to improve the implementation of processes to help raise team productivity; and
- ◆ Highlighting contributions of each audit in the lessons learned repository of the organization.

The subsequent effort to correct any deficiencies should result in a reduced cost of quality and an increase in sponsor or customer acceptance of the project's product. Quality audits may be scheduled or random, and may be conducted by internal or external auditors.

Quality audits can confirm the implementation of approved change requests including updates, corrective actions, defect repairs, and preventive actions.

8.2.2.6 DESIGN FOR X

Design for X (DfX) is a set of technical guidelines that may be applied during the design of a product for the optimization of a specific aspect of the design. DfX can control or even improve the product's final characteristics. The X in DfX can be different aspects of product development, such as reliability, deployment, assembly, manufacturing, cost, service, usability, safety, and quality. Using the DfX may result in cost reduction, quality improvement, better performance, and customer satisfaction.

8.2.2.7 PROBLEM SOLVING

Problem solving entails finding solutions for issues or challenges. It can include gathering additional information, critical thinking, creative, quantitative and/or logical approaches. Effective and systematic problem solving is a fundamental element in quality assurance and quality improvement. Problems can arise as a result of the Control Quality process or from quality audits and can be associated with a process or deliverable. Using a structured problem-solving method will help eliminate the problem and develop a long-lasting solution. Problem-solving methods generally include the following elements:

- ◆ Defining the problem,
- ◆ Identifying the root-cause,
- ◆ Generating possible solutions,
- ◆ Choosing the best solution,
- ◆ Implementing the solution, and
- ◆ Verifying solution effectiveness.

8.2.2.8 QUALITY IMPROVEMENT METHODS

Quality improvements can occur based on findings and recommendations from quality control processes, the findings of the quality audits, or problem solving in the Manage Quality process. Plan-do-check-act and Six Sigma are two of the most common quality improvement tools used to analyze and evaluate opportunities for improvement.

8.2.3 MANAGE QUALITY: OUTPUTS

8.2.3.1 QUALITY REPORTS

The quality reports can be graphical, numerical, or qualitative. The information provided can be used by other processes and departments to take corrective actions in order to achieve the project quality expectations. The information presented in the quality reports may include all quality management issues escalated by the team; recommendations for process, project, and product improvements; corrective actions recommendations (including rework, defect/bugs repair, 100% inspection, and more); and the summary of findings from the Control Quality process.

8.2.3.2 TEST AND EVALUATION DOCUMENTS

Test and evaluation documents can be created based on industry needs and the organization's templates. They are inputs to the Control Quality process and are used to evaluate the achievement of quality objectives. These documents may include dedicated checklists and detailed requirements traceability matrices as part of the document.

8.2.3.3 CHANGE REQUESTS

Described in Section 4.3.3.4. If changes occur during the Manage Quality process that impact any of the components of the project management plan, project documents, or project or product management processes, the project manager should submit a change request and follow the Perform Integrated Change Control process as defined in Section 4.6.

8.2.3.4 PROJECT MANAGEMENT PLAN UPDATES

Any change to the project management plan goes through the organization's change control process via a change request. Components that may require a change request for the project management plan include but are not limited to:

- ◆ **Quality management plan.** Described in Section 8.1.3.1. The agreed-upon approach to managing quality may need to be modified due to the actual results.
- ◆ **Scope baseline.** Described in Section 5.4.3.1. The scope baseline may change as a result of specific quality management activities.
- ◆ **Schedule baseline.** Described in Section 6.5.3.1. The schedule baseline may change as a result of specific quality management activities.
- ◆ **Cost baseline.** Described in Section 7.3.3.1. The cost baseline may change as a result of specific quality management activities.

8.2.3.5 PROJECT DOCUMENTS UPDATES

Project documents that may be updated as a result of carrying out this process include but are not limited to:

- ◆ **Issue log.** Described in Section 4.3.3.3. New issues raised as a result of this process are recorded in the issue log.
- ◆ **Lessons learned register.** Described in Section 4.4.3.1. The lessons learned register is updated with information on challenges encountered and how they could have been avoided as well as approaches that worked well for the managing quality.
- ◆ **Risk register.** Described in Section 11.2.3.1. New risks identified during this process are recorded in the risk register and managed using the risk management processes.



8.3 CONTROL QUALITY

Control Quality is the process of monitoring and recording results of executing the quality management activities in order to assess performance and ensure the project outputs are complete, correct, and meet customer expectations. The key benefit of this process is verifying that project deliverables and work meet the requirements specified by key stakeholders for final acceptance. The Control Quality process determines if the project outputs do what they were intended to do. Those outputs need to comply with all applicable standards, requirements, regulations, and specifications. This process is performed throughout the project.

The inputs, tools and techniques, and outputs of this process are depicted in Figure 8-10. Figure 8-11 depicts the data flow diagram of the process.

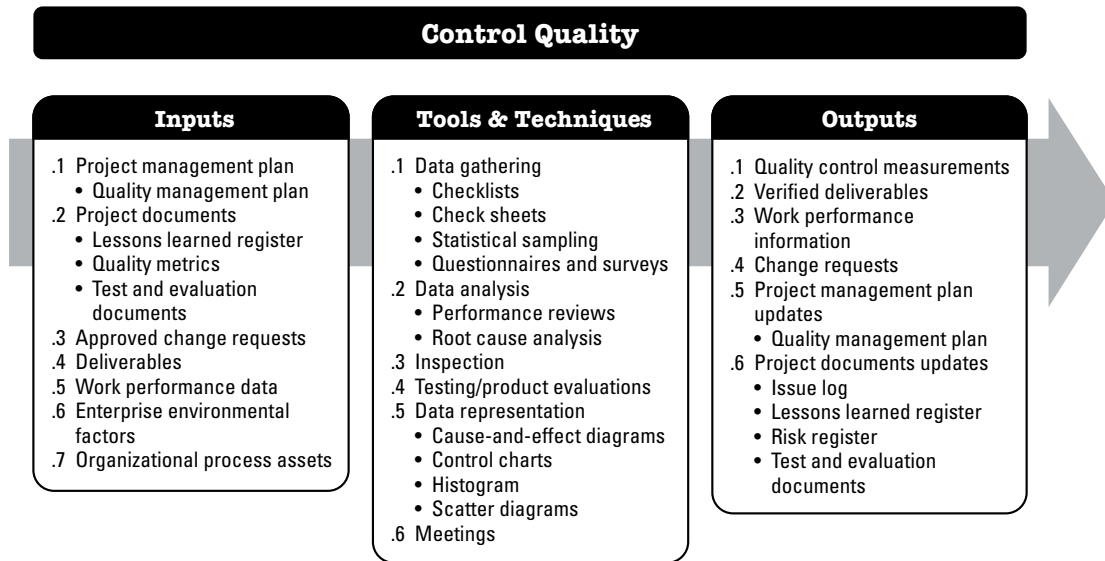

Figure 8-10. Control Quality: Inputs, Tools & Techniques, and Outputs

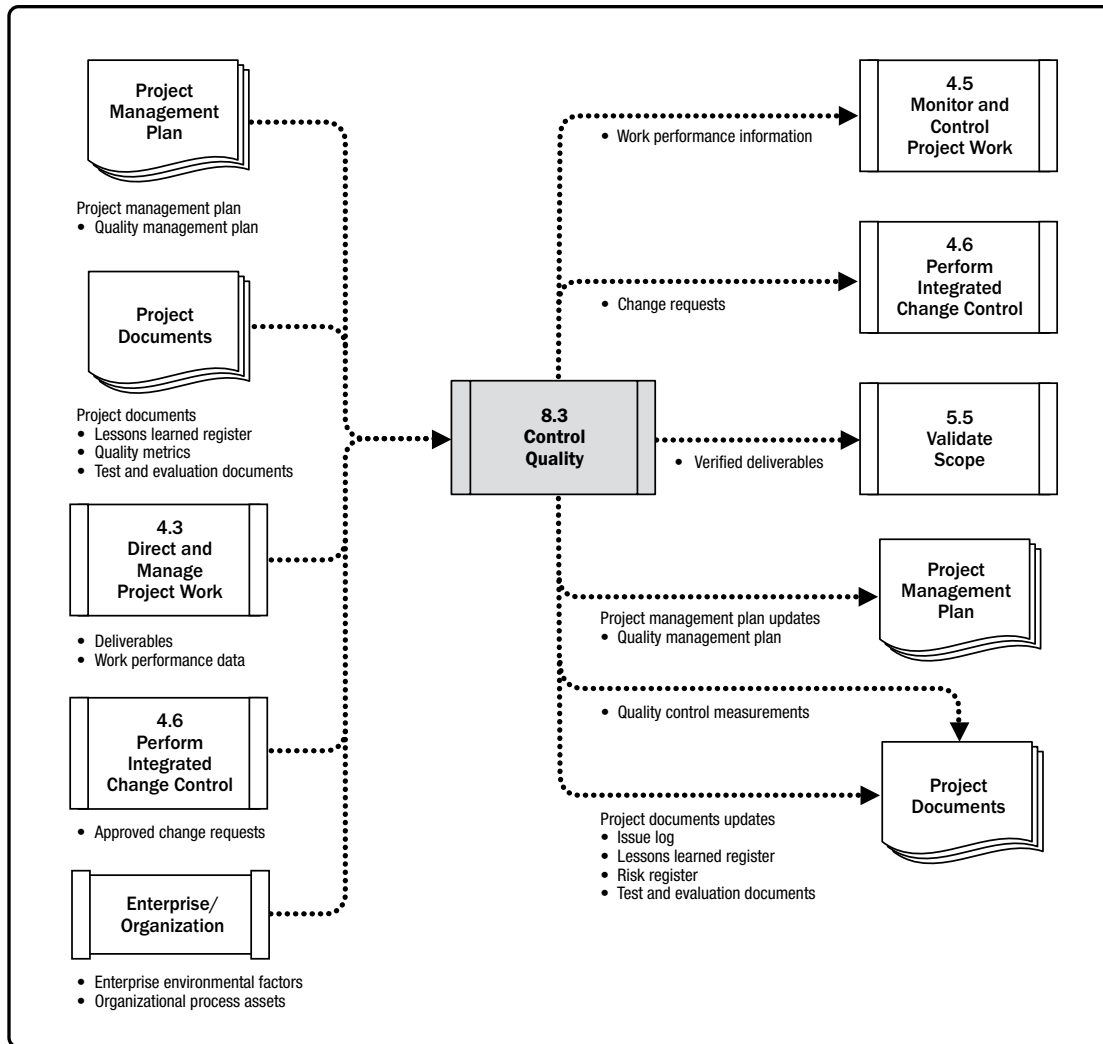

Figure 8-11. Control Quality: Data Flow Diagram

The Control Quality process is performed to measure the completeness, compliance, and fitness for use of a product or service prior to user acceptance and final delivery. This is done by measuring all steps, attributes, and variables used to verify conformance or compliance to the specifications stated during the planning stage.

Quality control should be performed throughout the project to formally demonstrate, with reliable data, that the sponsor's and/or customer's acceptance criteria have been met.

The level of effort to control quality and the degree of implementation may differ between industries and project management styles; in pharmaceutical, health, transportation, and nuclear industries, for example, there may be stricter quality control procedures compared to other industries, and the effort needed to meet the standards may be extensive. For example, in agile projects, the Control Quality activities may be performed by all team members throughout the project life cycle. In waterfall model-based projects, the quality control activities are performed at specific times, toward the end of the project or phase, by specified team members.

8.3.1 CONTROL QUALITY: INPUTS

8.3.1.1 PROJECT MANAGEMENT PLAN

Described in Section 4.2.3.1. Project management plan components include but are not limited to the quality management plan. Described in Section 8.1.3.1, the quality management plan defines how quality control will be performed within the project.

8.3.1.2 PROJECT DOCUMENTS

Project documents that can be considered as inputs for this process include but are not limited to:

- ◆ **Lessons learned register.** Described in Section 4.4.3.1. Lessons learned earlier in the project can be applied to later phases in the project to improve quality control.
- ◆ **Quality metrics.** Described in Section 8.1.3.2. A quality metric specifically describes a project or product attribute and how the Control Quality process will verify compliance to it.
- ◆ **Test and evaluation documents.** Described in Section 8.2.3.2. Test and evaluation documents are used to evaluate achievement of the quality objectives.

8.3.1.3 APPROVED CHANGE REQUESTS

Described in Section 4.6.3.1. As part of the Perform Integrated Change Control process, a change log update indicates that some changes are approved and some are not. Approved change requests may include modifications such as defect repairs, revised work methods, and revised schedules. Partial change completion may result in inconsistencies and later delays due to incomplete steps or corrections. The implementation of approved changes should be verified, confirmed for completeness, retested, and certified as correct.

8.3.1.4 DELIVERABLES

A deliverable is any unique and verifiable product, result, or capability to perform a service that is required to be produced to complete a process, phase, or project. Deliverables that are outputs from the Direct and Manage Project Work process are inspected and compared to the acceptance criteria defined in the project scope statement.

8.3.1.5 WORK PERFORMANCE DATA

Described in Section 4.3.3.2. Work performance data contains data on product status such as observations, quality metrics, and measurements for technical performance, as well as project quality information on schedule performance and cost performance.

8.3.1.6 ENTERPRISE ENVIRONMENTAL FACTORS

The enterprise environmental factors that can influence the Control Quality process include but are not limited to:

- ◆ Project management information system; quality management software can be used to track errors and variations in processes or deliverables;
- ◆ Governmental agency regulations; and
- ◆ Rules, standards, and guidelines specific to the application area.

8.3.1.7 ORGANIZATIONAL PROCESS ASSETS

The organizational process assets that can influence the Control Quality process include but are not limited to:

- ◆ Quality standards and policies;
- ◆ Quality templates, for example, check sheets, checklists, etc. and;
- ◆ Issue and defect reporting procedures and communication policies.

8.3.2 CONTROL QUALITY: TOOLS AND TECHNIQUES

8.3.2.1 DATA GATHERING

Data-gathering techniques that can be used for this process include but are not limited to:

- ◆ **Checklists.** Described in Section 11.2.2.2. Checklists help in managing the control quality activities in a structured manner.
- ◆ **Check sheets.** Check sheets are also known as tally sheets and are used to organize facts in a manner that will facilitate the effective collection of useful data about a potential quality problem. They are especially useful for gathering attributes data while performing inspections to identify defects; for example, data about the frequencies or consequences of defects collected. See Figure 8-12.

Defects/Date	Date 1	Date 2	Date 3	Date 4	Total
Small scratch	1	2	2	2	7
Large scratch	0	1	0	0	1
Bent	3	3	1	2	9
Missing component	5	0	2	1	8
Wrong color	2	0	1	3	6
Labeling error	1	2	1	2	6

Figure 8-12. Check Sheets

- ◆ **Statistical sampling.** Statistical sampling involves choosing part of a population of interest for inspection (for example, selecting 10 engineering drawings at random from a list of 75). The sample is taken to measure controls and verify quality. Sample frequency and sizes should be determined during the Plan Quality Management process.
- ◆ **Questionnaires and Surveys.** Surveys may be used to gather data about customer satisfaction after the deployment of the product or service. The cost regarding defects identified in the surveys may be considered external failure costs in the COQ model and can have extensive cost implications for the organization.

8.3.2.2 DATA ANALYSIS

Data analysis techniques that can be used for this process include but are not limited to:

- ◆ **Performance reviews.** Performance reviews measure, compare, and analyze the quality metrics defined by the Plan Quality Management process against the actual results.
- ◆ **Root cause analysis (RCA).** Described in Section 8.2.2.2. Root cause analysis is used to identify the source of defects.

8.3.2.3 INSPECTION

An inspection is the examination of a work product to determine if it conforms to documented standards. The results of inspections generally include measurements and may be conducted at any level. The results of a single activity can be inspected, or the final product of the project can be inspected. Inspections may be called reviews, peer reviews, audits, or walkthroughs. In some application areas, these terms have narrow and specific meanings. Inspections also are used to verify defect repairs.

8.3.2.4 TESTING/PRODUCT EVALUATIONS

Testing is an organized and constructed investigation conducted to provide objective information about the quality of the product or service under test in accordance with the project requirements. The intent of testing is to find errors, defects, bugs, or other nonconformance problems in the product or service. The type, amount, and extent of tests needed to evaluate each requirement are part of the project quality plan and depend on the nature of the project, time, budget, and other constraints. Tests can be performed throughout the project, as different components of the project become available, and at the end of the project on the final deliverables. Early testing helps identify nonconformance problems and helps reduce the cost of fixing the nonconforming components.

Different application areas require different tests. For example, software testing may include unit testing, integration testing, black-box, white-box, interface testing, regression testing, Alpha testing, etc. In construction projects, testing may include cement strength, concrete workability test, nondestructive tests at construction sites for testing the quality of hardened concrete structures, and soil tests. In hardware development, testing may include environmental stress screening, burn-in tests, system testing, and more.

8.3.2.5 DATA REPRESENTATION

Data representation techniques that can be used for this process include but are not limited to:

- ◆ **Cause-and-effect diagrams.** Described in Section 8.2.2.4. Cause-and-effect diagrams are used to identify the possible effects of quality defects and errors.
- ◆ **Control charts.** Control charts are used to determine whether or not a process is stable or has predictable performance. Upper and lower specification limits are based on the requirements and reflect the maximum and minimum values allowed. Upper and lower control limits are different from specification limits. The control limits are determined using standard statistical calculations and principles to ultimately establish the natural capability for a stable process. The project manager and appropriate stakeholders may use the statistically calculated control limits to identify the points at which corrective action will be taken to prevent performance that remains outside the control limits. Control charts can be used to monitor various types of output variables. Although used most frequently to track repetitive activities required for producing manufactured lots, control charts may also be used to monitor cost and schedule variances, volume, frequency of scope changes, or other management results to help determine if the project management processes are in control.
- ◆ **Histograms.** Described in Section 8.2.2.4. Histograms can demonstrate the number of defects by source or by component.
- ◆ **Scatter diagrams.** Described in Section 8.2.2.4. Scatter diagrams can show the planned performance on one axis and the actual performance on the second axis.

8.3.2.6 MEETINGS

The following meetings may be used as part of the Control Quality process:

- ◆ **Approved change requests review.** All approved change requests should be reviewed to verify that they were implemented as approved. This review should also check that partial changes are completed and all parts have been properly implemented, tested, completed, and certified.
- ◆ **Retrospectives/lesson learned.** A meeting held by a project team to discuss:
 - Successful elements in the project/phase,
 - What could be improved,
 - What to incorporate in the ongoing project and what in future projects, and
 - What to add to the organization process assets.

8.3.3 CONTROL QUALITY: OUTPUTS

8.3.3.1 QUALITY CONTROL MEASUREMENTS

Quality control measurements are the documented results of Control Quality activities. They should be captured in the format that was specified in the quality management plan.

8.3.3.2 VERIFIED DELIVERABLES

A goal of the Control Quality process is to determine the correctness of deliverables. The results of performing the Control Quality process are verified deliverables that become an input to the Validate Scope process (Section 5.5) for formalized acceptance. If there were any change requests or improvements related to the deliverables, they may be changed, inspected, and reverified.

8.3.3.3 WORK PERFORMANCE INFORMATION

Described in Section 4.5.1.3. Work performance information includes information on project requirements fulfillment, causes for rejections, rework required, recommendations for corrective actions, lists of verified deliverables, status of the quality metrics, and the need for process adjustments.

8.3.3.4 CHANGE REQUESTS

Described in Section 4.3.3.4. If changes occur during the Control Quality process that may impact any of the components of the project management plan or project documents, the project manager should submit a change request. Change requests are processed for review and disposition through the Perform Integrated Change Control process (Section 4.6).

8.3.3.5 PROJECT MANAGEMENT PLAN UPDATES

Any change to the project management plan goes through the organization's change control process via a change request. Components that may require a change request for the project management plan include but are not limited to the quality management plan, as described in Section 8.1.3.1.

8.3.3.6 PROJECT DOCUMENTS UPDATES

Project documents that may be updated as a result of carrying out this process include but are not limited to:

- ◆ **Issue log.** Described in Section 4.3.3.3. Many times a deliverable that does not meet the quality requirements is documented as an issue.
- ◆ **Lessons learned register.** Described in Section 4.4.3.1. The lessons learned register is updated with information on the source of quality defects and how they could have been avoided as well as approaches that worked well.
- ◆ **Risk register.** Described in Section 11.2.3.1. New risks identified during this process are recorded in the risk register and managed using the risk management processes.
- ◆ **Test and evaluation documents.** Described in Section 8.2.3.2. Test and evaluation documents may be modified as a result of this process in order to make future tests more effective.

9

PROJECT RESOURCE MANAGEMENT

Project Resource Management includes the processes to identify, acquire, and manage the resources needed for the successful completion of the project. These processes help ensure that the right resources will be available to the project manager and project team at the right time and place.

The Project Resource Management processes are:

9.1 Plan Resource Management—The process of defining how to estimate, acquire, manage, and utilize physical and team resources.

9.2 Estimate Activity Resources—The process of estimating team resources and the type and quantities of material, equipment, and supplies necessary to perform project work.

9.3 Acquire Resources—The process of obtaining team members, facilities, equipment, materials, supplies, and other resources necessary to complete project work.

9.4 Develop Team—The process of improving competencies, team member interaction, and the overall team environment to enhance project performance.

9.5 Manage Team—The process of tracking team member performance, providing feedback, resolving issues, and managing team changes to optimize project performance.

9.6 Control Resources—The process of ensuring that the physical resources assigned and allocated to the project are available as planned, as well as monitoring the planned versus actual use of resources, and performing corrective action as necessary.

Figure 9-1 provides an overview of the Project Resource Management processes. The Project Resource Management processes are presented as discrete processes with defined interfaces while, in practice, they overlap and interact in ways that cannot be completely detailed in the *PMBOK® Guide*.



Figure 9-1. Project Resource Management Overview

There is a distinction between the skills and competencies needed for the project manager to manage team resources versus physical resources. Physical resources include equipment, materials, facilities, and infrastructure. Team resources or personnel refer to the human resources. Personnel may have varied skill sets, may be assigned full- or part-time, and may be added or removed from the project team as the project progresses. There is some overlap between Project Resource Management and Project Stakeholder Management (Section 13). This section (Section 9) focuses on the subset of stakeholders who make up the project team.

KEY CONCEPTS FOR PROJECT RESOURCE MANAGEMENT

The project team consists of individuals with assigned roles and responsibilities who work collectively to achieve a shared project goal. The project manager should invest suitable effort in acquiring, managing, motivating, and empowering the project team. Although specific roles and responsibilities for the project team members are assigned, the involvement of all team members in project planning and decision making is beneficial. Participation of team members during planning adds their expertise to the process and strengthens their commitment to the project.

The project manager should be both leader and manager of the project team. In addition to project management activities such as initiating, planning, executing, monitoring and controlling, and closing the various project phases, the project manager is responsible for the team formation as an effective group. The project manager should be aware of different aspects that influence the team, such as:

- ◆ Team environment,
- ◆ Geographical locations of team members,
- ◆ Communications among stakeholders,
- ◆ Organizational change management,
- ◆ Internal and external politics,
- ◆ Cultural issues and organizational uniqueness, and
- ◆ Other factors that may alter project performance.

As a leader, the project manager is also responsible for proactively developing team skills and competencies while retaining and improving team satisfaction and motivation. The project manager should be aware of, and subscribe to, professional and ethical behavior, and ensure that all team members adhere to these behaviors.

Physical resource management is concentrated in allocating and using the physical resources (material, equipment, and supplies, for example) needed for successful completion of the project in an efficient and effective way. In order to do that, organizations should have data on resource demands (now and in the reasonable future), resource configurations that will be required to meet those demands, and the supply of resources. Failing to manage and control resources efficiently is a source of risk for successful project completion. For example:

- ◆ Failing to secure critical equipment or infrastructure on time may result in delays in the manufacturing of the final product,
- ◆ Ordering low-quality material may damage the quality of the product causing a high rate of recalls or rework, and
- ◆ Keeping too much inventory may result in high operations costs and reduce the organization's profit. Unacceptably low inventory level, on the other hand, may result in not satisfying customer demand and, again, reduce the organization's profit.

TRENDS AND EMERGING PRACTICES IN PROJECT RESOURCE MANAGEMENT

Project management styles are shifting away from a command and control structure for managing projects and toward a more collaborative and supportive management approach that empowers teams by delegating decision making to the team members. In addition, modern project resource management approaches seek to optimize resource utilization. Trends and emerging practices for Project Resource Management include but are not limited to:

- ◆ **Resource management methods.** Due to the scarce nature of critical resources, in some industries, several trends have become popular in the past several years. There is extensive literature about lean management, just-in-time (JIT) manufacturing, Kaizen, total productive maintenance (TPM), theory of constraints (TOC), and other methods. A project manager should determine if the performing organization has adopted one or more resource management tools and adapt the project accordingly.
- ◆ **Emotional intelligence (EI).** The project manager should invest in personal EI by improving inbound (e.g., self-management and self-awareness) and outbound (e.g., relationship management) competencies. Research suggests that project teams that succeed in developing team EI or become an emotionally competent group are more effective. Additionally, there is a reduction in staff turnover.
- ◆ **Self-organizing teams.** The increase in using agile approaches mainly for the execution of IT projects has given rise to the self-organizing team, where the team functions with an absence of centralized control. In projects that have self-organizing teams, the project manager (who may not be called a project manager) role provides the team with the environment and support needed and trusts the team to get the job done. Successful self-organizing teams usually consist of generalized specialists, instead of subject matter experts, who continuously adapt to the changing environment and embrace constructive feedback.

- ◆ **Virtual teams/distributed teams.** The globalization of projects has promoted the need for virtual teams that work on the same project, but are not colocated at the same site. The availability of communication technology such as email, audio conferencing, social media, web-based meetings, and video conferencing has made virtual teams feasible. Managing virtual teams has unique advantages, such as being able to use special expertise on a project team even when the expert is not in the same geographic area, incorporating employees who work from home offices, and including people with mobility limitations or disabilities. The challenges of managing virtual teams are mainly in the communication domain, including a possible feeling of isolation, gaps in sharing knowledge and experience between team members, and difficulties in tracking progress and productivity, possible time zone difference and cultural differences.

TAILORING CONSIDERATIONS

Because each project is unique, the project manager will need to tailor the way Project Resource Management processes are applied. Considerations for tailoring include but are not limited to:

- ◆ **Diversity.** What is the diversity background of the team?
- ◆ **Physical location.** What is the physical location of team members and physical resources?
- ◆ **Industry-specific resources.** What special resources are needed in the industry?
- ◆ **Acquisition of team members.** How will team members be acquired for the project? Are team resources full-time or part-time on the project?
- ◆ **Management of team.** How is team development managed for the project? Are there organizational tools to manage team development or will new ones need to be established? Are there team members who have special needs? Will the team need special training to manage diversity?
- ◆ **Life cycle approaches.** What life cycle approach will be used on the project?

CONSIDERATIONS FOR AGILE/ADAPTIVE ENVIRONMENTS

Projects with high variability benefit from team structures that maximize focus and collaboration, such as self-organizing teams with generalizing specialists.

Collaboration is intended to boost productivity and facilitate innovative problem solving. Collaborative teams may facilitate accelerated integration of distinct work activities, improve communication, increase knowledge sharing, and provide flexibility of work assignments in addition to other advantages.

Although the benefits of collaboration also apply to other project environments, collaborative teams are often critical to the success of projects with a high degree of variability and rapid changes, because there is less time for centralized tasking and decision making.

Planning for physical and human resources is much less predictable in projects with high variability. In these environments, agreements for fast supply and lean methods are critical to controlling costs and achieving the schedule.

9.1 PLAN RESOURCE MANAGEMENT

Plan Resource Management is the process of defining how to estimate, acquire, manage, and use team and physical resources. The key benefit of this process is that it establishes the approach and level of management effort needed for managing project resources based on the type and complexity of the project. This process is performed once or at predefined points in the project. The inputs, tools and techniques, and outputs of the process are depicted in Figure 9-2. Figure 9-3 depicts the data flow diagram for the process.

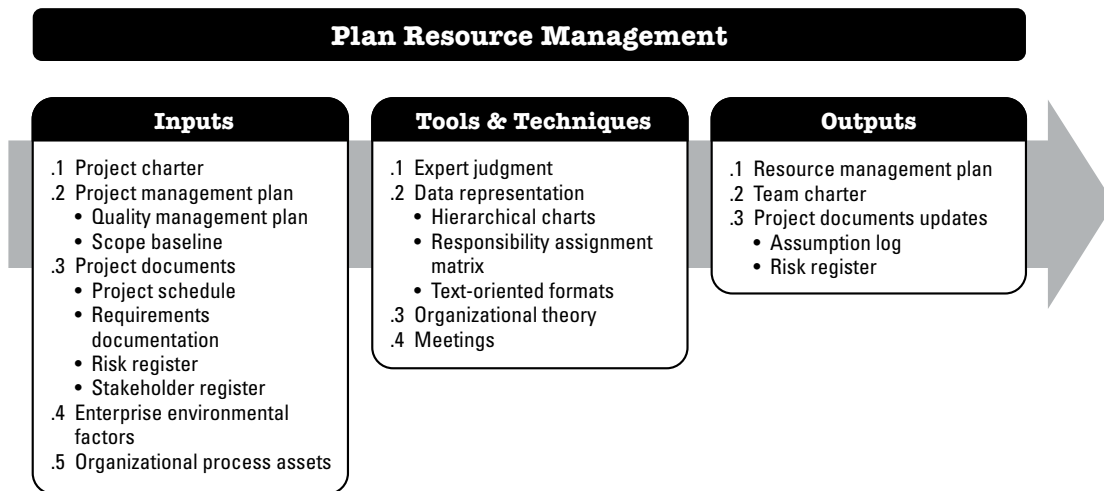

Figure 9-2. Plan Resource Management: Inputs, Tools & Techniques, and Outputs

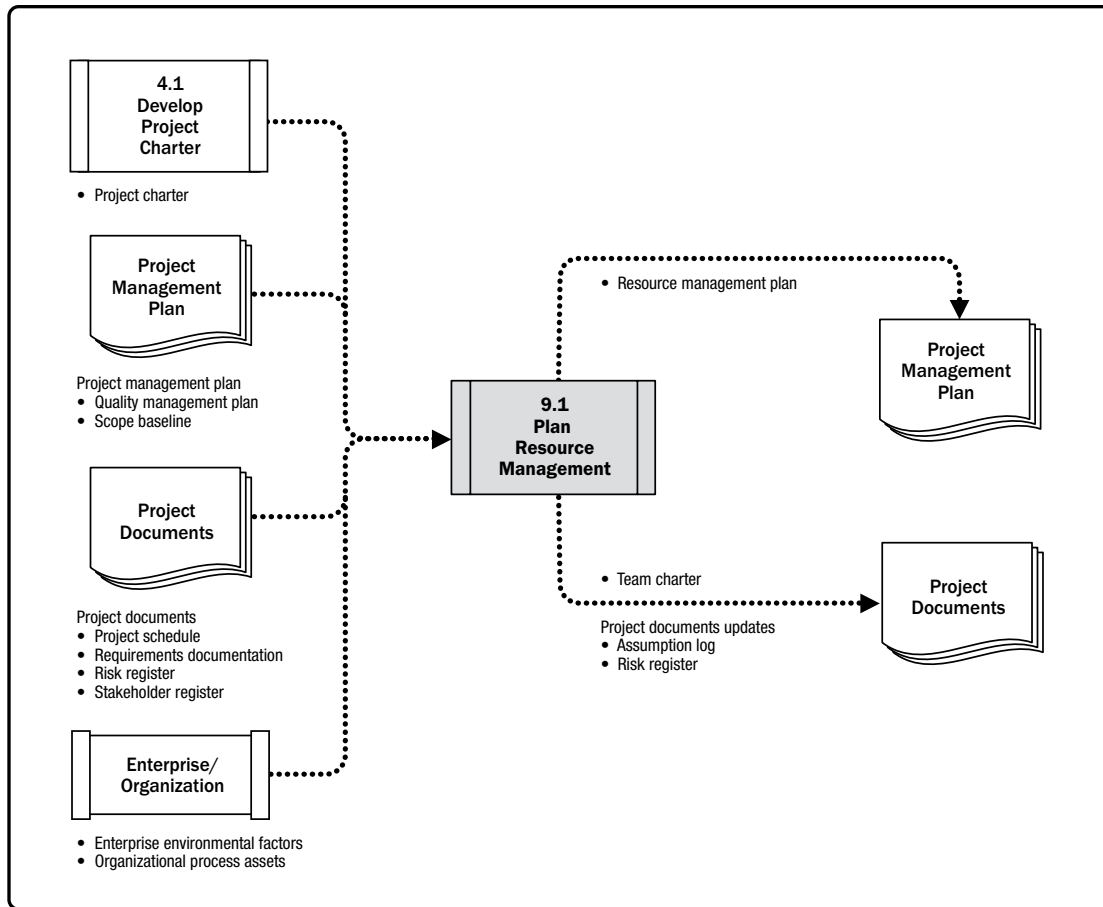

Figure 9-3. Plan Resource Management: Data Flow Diagram

Resource planning is used to determine and identify an approach to ensure that sufficient resources are available for the successful completion of the project. Project resources may include team members, supplies, materials, equipment, services and facilities. Effective resource planning should consider and plan for the availability of, or competition for, scarce resources.

Those resources can be obtained from the organization's internal assets or from outside the organization through a procurement process. Other projects may be competing for the same resources required for the project at the same time and location. This may significantly impact project costs, schedules, risks, quality, and other project areas.

9.1.1 PLAN RESOURCE MANAGEMENT: INPUTS

9.1.1.1 PROJECT CHARTER

Described in Section 4.1.3.1. The project charter provides the high-level project description and requirements. It also has the key stakeholder list, summary milestones, and preapproved financial resources that may influence the resource management of the project.

9.1.1.2 PROJECT MANAGEMENT PLAN

Described in Section 4.2.3.1. Project management plan components include but are not limited to:

- ◆ **Quality management plan.** Described in Section 8.1.3.1. The quality management plan helps define the level of resources that will be required to achieve and maintain the defined level of quality and achieve the metrics for the project.
- ◆ **Scope baseline.** Described in Section 5.4.3.1. The scope baseline identifies the deliverables that drive the types and quantities of resources that will need to be managed.

9.1.1.3 PROJECT DOCUMENTS

Project documents that can be considered as inputs for this process include but are not limited to:

- ◆ **Project schedule.** Described in Section 6.5.3.2. The project schedule shows the timeline for needed resources.
- ◆ **Requirements documentation.** Described in Section 5.2.3.1. Requirements will dictate the type and amount of resources needed for the project and may influence how they are managed.
- ◆ **Risk register.** Described in Section 11.2.3.1. The risk register contains information on threats and opportunities that may impact resource planning.
- ◆ **Stakeholder register.** Described in Section 13.1.3.1. The stakeholder register aids in identifying those stakeholders who have a particular interest in or an impact on resources needed for the project. It also helps to identify stakeholders who can influence the use of one kind of resource over another.

9.1.1.4 ENTERPRISE ENVIRONMENTAL FACTORS

The enterprise environmental factors that can influence the Plan Resource Management include but are not limited to:

- ◆ Organizational culture and structure,
- ◆ Geographic distribution of facilities and resources,
- ◆ Existing resources competencies and availability, and
- ◆ Marketplace conditions.

9.1.1.5 ORGANIZATIONAL PROCESS ASSETS

The organizational process assets that can influence the Plan Resource Management include but are not limited to:

- ◆ Human resource policies and procedures,
- ◆ Physical resource management policies and procedures,
- ◆ Safety policies,
- ◆ Security policies,
- ◆ Templates for the resource management plan, and
- ◆ Historical information for similar projects.

9.1.2 PLAN RESOURCE MANAGEMENT: TOOLS AND TECHNIQUES

9.1.2.1 EXPERT JUDGMENT

Described in Section 4.1.2.1. Expertise should be considered from individuals or groups with specialized knowledge or training in the following topics:

- ◆ Negotiating for the best resources within the organization;
- ◆ Talent management and personnel development;
- ◆ Determining the preliminary effort level needed to meet project objectives;
- ◆ Determining reporting requirements based on the organizational culture;
- ◆ Estimating lead times required for acquisition, based on lessons learned and market conditions;
- ◆ Identifying risks associated with resource acquisition, retention, and release plans;
- ◆ Complying with applicable government and union regulations; and
- ◆ Managing sellers and the logistics effort to ensure materials and supplies are available when needed.

9.1.2.2 DATA REPRESENTATION

Data representation techniques that can be used for this process include but are not limited to charts. Various formats exist to document and communicate team member roles and responsibilities. Most fall into hierarchical, matrix, or text-oriented formats. Some project assignments are listed in subsidiary plans, such as the risk, quality, or communications management plans. Regardless of the method used to document team member roles, the objective is to ensure that each work package has an unambiguous owner and that all team members have a clear understanding of their roles and responsibilities. A hierarchical format may be used to represent high-level roles, while a text-based format may be better suited to document the detailed responsibilities.

- ◆ **Hierarchical charts.** The traditional organizational chart structure can be used to show positions and relationships in a graphical, top-down format.
 - *Work breakdown structures (WBS).* The WBS is designed to show how project deliverables are broken down into work packages and provide a way of showing high-level areas of responsibility.
 - *Organizational breakdown structure (OBS).* While the WBS shows a breakdown of project deliverables, an OBS is arranged according to an organization's existing departments, units, or teams, with the project activities or work packages listed under each department. An operational department, such as information technology or purchasing, can see all of its project responsibilities by looking at its portion of the OBS.
 - *Resource breakdown structure.* The resource breakdown structure is a hierarchical list of team and physical resources related by category and resource type that is used for planning, managing and controlling project work. Each descending (lower) level represents an increasingly detailed description of the resource until the information is small enough to be used in conjunction with the work breakdown structure (WBS) to allow the work to be planned, monitored, and controlled.

- ◆ **Assignment Matrix.** A RAM shows the project resources assigned to each work package. It is used to illustrate the connections between work packages, or activities, and project team members. On larger projects, RAMs can be developed at various levels. For example, a high-level RAM can define the responsibilities of a project team, group, or unit within each component of the WBS. Lower-level RAMs are used within the group to designate roles, responsibilities, and levels of authority for specific activities. The matrix format shows all activities associated with one person and all people associated with one activity. This also ensures that there is only one person accountable for any one task to avoid confusion about who is ultimately in charge or has authority for the work. One example of a RAM is a RACI (responsible, accountable, consult, and inform) chart, shown in Figure 9-4. The sample chart shows the work to be done in the left column as activities. The assigned resources can be shown as individuals or groups. The project manager can select other options, such as “lead” and “resource” designations, as appropriate for the project. A RACI chart is a useful tool to use to ensure clear assignment of roles and responsibilities when the team consists of internal and external resources.
- ◆ **Text-oriented formats.** Team member responsibilities that require detailed descriptions can be specified in text-oriented formats. Usually in outline form, these documents provide information such as responsibilities, authority, competencies, and qualifications. The documents are known by various names including position descriptions and role-responsibility-authority forms. These documents can be used as templates for future projects, especially when the information is updated throughout the current project by applying lessons learned.

RACI Chart	Person				
Activity	Ann	Ben	Carlos	Dina	Ed
Create charter	A	R	I	I	I
Collect requirements	I	A	R	C	C
Submit change request	I	A	R	R	C
Develop test plan	A	C	I	I	R

R = Responsible A = Accountable C = Consult I = Inform

Figure 9-4. Sample RACI Chart

9.1.2.3 ORGANIZATIONAL THEORY

Organizational theory provides information regarding the way in which people, teams, and organizational units behave. Effective use of common techniques identified in organizational theory can shorten the amount of time, cost, and effort needed to create the Plan Resource Management process outputs and improve planning efficiency. Applicable organizational theories may recommend exercising a flexible leadership style that adapts to the changes in a team's maturity level throughout the project life cycle. It is important to recognize that the organization's structure and culture impacts the project organizational structure.

9.1.2.4 MEETINGS

The project team may hold meetings to plan resource management for the project.

9.1.3 PLAN RESOURCE MANAGEMENT: OUTPUTS

9.1.3.1 RESOURCE MANAGEMENT PLAN

The resource management plan is the component of the project management plan that provides guidance on how project resources should be categorized, allocated, managed, and released. It may be divided between the team management plan and physical resource management plan according to the specifics of the project. The resource management plan may include but is not limited to:

- ◆ **Identification of resources.** Methods for identifying and quantifying team and physical resources needed.
- ◆ **Acquiring resources.** Guidance on how to acquire team and physical resources for the project.
- ◆ **Roles and responsibilities:**
 - *Role.* The function assumed by, or assigned to, a person in the project. Examples of project roles are civil engineer, business analyst, and testing coordinator.
 - *Authority.* The rights to apply project resources, make decisions, sign approvals, accept deliverables, and influence others to carry out the work of the project. Examples of decisions that need clear authority include the selection of a method for completing an activity, quality acceptance criteria, and how to respond to project variances. Team members operate best when their individual levels of authority match their individual responsibilities.

- *Responsibility.* The assigned duties and work that a project team member is expected to perform in order to complete the project's activities.
- *Competence.* The skill and capacity required to complete assigned activities within the project constraints. If project team members do not possess required competencies, performance can be jeopardized. When such mismatches are identified, proactive responses such as training, hiring, schedule changes, or scope changes are initiated.
- ◆ **Project organization charts.** A project organization chart is a graphic display of project team members and their reporting relationships. It can be formal or informal, highly detailed or broadly framed, based on the needs of the project. For example, the project organization chart for a 3,000-person disaster response team will have greater detail than a project organization chart for an internal, 20-person project.
- ◆ **Project team resource management.** Guidance on how project team resources should be defined, staffed, managed, and eventually released.
- ◆ **Training.** Training strategies for team members.
- ◆ **Team development.** Methods for developing the project team.
- ◆ **Resource control.** Methods for ensuring adequate physical resources are available as needed and that the acquisition of physical resources is optimized for project needs. Includes information on managing inventory, equipment, and supplies during throughout the project life cycle.
- ◆ **Recognition plan.** Which recognition and rewards will be given to team members, and when they will be given.

9.1.3.2 TEAM CHARTER

The team charter is a document that establishes the team values, agreements, and operating guidelines for the team. The team charter may include but is not limited to:

- ◆ Team values,
- ◆ Communication guidelines,
- ◆ Decision-making criteria and process,
- ◆ Conflict resolution process,
- ◆ Meeting guidelines, and
- ◆ Team agreements.

The team charter establishes clear expectations regarding acceptable behavior by project team members. Early commitment to clear guidelines decreases misunderstandings and increases productivity. Discussing areas such as codes of conduct, communication, decision making, and meeting etiquette allows team members to discover values that are important to one another. The team charter works best when the team develops it, or at least has an opportunity to contribute to it. All project team members share responsibility for ensuring the rules documented in the team charter are followed. The team charter can be reviewed and updated periodically to ensure a continued understanding of the team ground rules and to orient and integrate new team members.

9.1.3.3 PROJECT DOCUMENTS UPDATES

Project documents that may be updated as a result of carrying out this process include but are not limited to:

- ◆ **Assumption log.** Described in Section 4.1.3.2. The assumption log is updated with assumptions regarding the availability, logistics requirements, and location of physical resources as well as the skill sets and availability of team resources.
- ◆ **Risk register.** Described in Section 11.2.3.1. The risk register is updated with risks associated with team and physical resource availability or other known resource-related risks.

9.2 ESTIMATE ACTIVITY RESOURCES

Estimate Activity Resources is the process of estimating team resources and the type and quantities of materials, equipment, and supplies necessary to perform project work. The key benefit of this process is that it identifies the type, quantity, and characteristics of resources required to complete the project. This process is performed periodically throughout the project as needed. The inputs, tools and techniques, and outputs of this process are depicted in Figure 9-5. Figure 9-6 depicts the data flow diagram of the process.

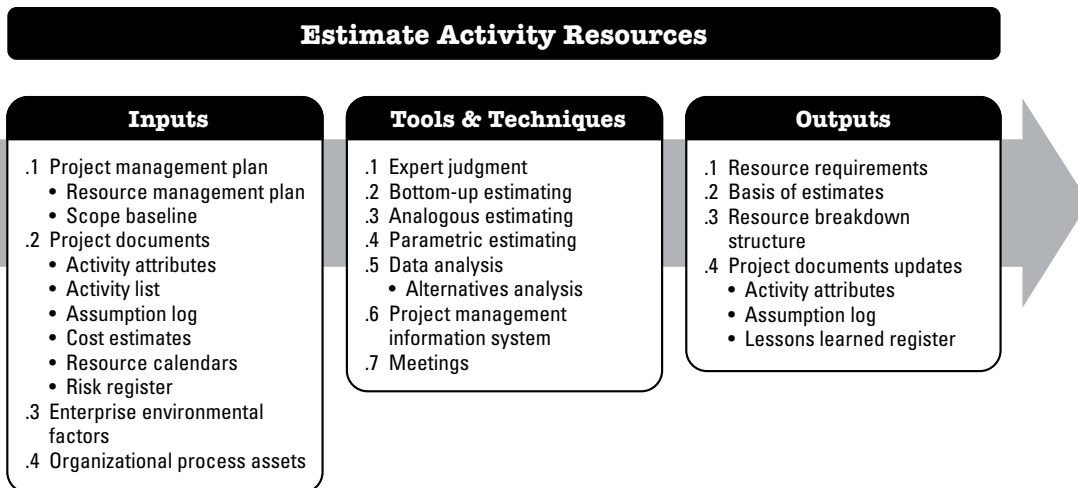

Figure 9-5. Estimate Activity Resources: Inputs, Tools & Techniques, and Outputs

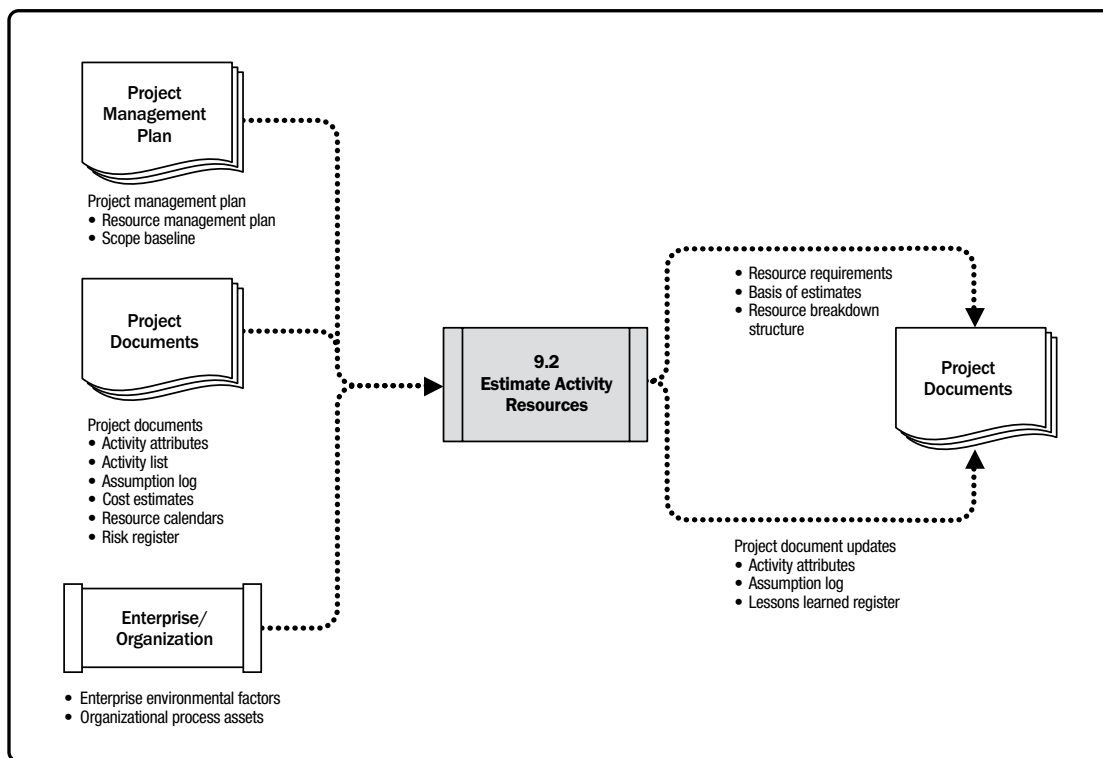

Figure 9-6. Estimate Activity Resources: Data Flow Diagram

The Estimate Activity Resources process is closely coordinated with other processes, such as the Estimate Costs process. For example:

- ◆ A construction project team will need to be familiar with local building codes. Such knowledge is often readily available from local sellers. If the internal labor pool lacks experience with unusual or specialized construction techniques, the additional cost for a consultant may be the most effective way to secure knowledge of the local building codes.
- ◆ An automotive design team will need to be familiar with the latest automated assembly techniques. The requisite knowledge could be obtained by hiring a consultant, by sending a designer to a seminar on robotics, or by including someone from manufacturing as a member of the project team.

9.2.1 ESTIMATE ACTIVITY RESOURCES: INPUTS

9.2.1.1 PROJECT MANAGEMENT PLAN

Described in Section 4.2.3.1. Project management plan components include but are not limited to:

- ◆ **Resource management plan.** Described in Section 9.1.3.1. The resource management plan defines the approach to identify the different resources needed for the project. It also defines the methods to quantify the resources needed for each activity and aggregates this information.
- ◆ **Scope baseline.** Described in Section 5.4.3.1. The scope baseline identifies the project and product scope necessary to meet the project objectives. The scope drives the needs for both team and physical resources.

9.2.1.2 PROJECT DOCUMENTS

Project documents that can be considered as inputs for this process include but are not limited to:

- ◆ **Activity attributes.** Described in Section 6.2.3.2. Activity attributes provide the primary data source for use in estimating team and physical resources required for each activity on the activity list. Examples of attributes include the resource requirements, imposed dates, activity location, assumptions, and constraints.
- ◆ **Activity list.** Described in Section 6.2.3.1. The activity list identifies the activities that will need resources.

- ◆ **Assumption log.** Described in Section 4.1.3.2. The assumption log may have information on productivity factors, availability, cost estimates, and approaches to work that will influence the nature and number of team and physical resources.
- ◆ **Cost estimates.** Described in Section 7.2.3.1. The cost of resources may impact resource selection from the quantity and skill level perspectives.
- ◆ **Resource calendars.** A resource calendar identifies the working days, shifts, start and end of normal business hours, weekends, and public holidays when each specific resource is available. Information on which resources (such as team resource, equipment, and material) are potentially available during a planned activity period is used for estimating resource utilization. Resource calendars also specify when, and for how long, identified team and physical resources will be available during the project. This information may be at the activity or project level. This includes consideration of attributes such as resource experience and/or skill level, as well as various geographical locations.
- ◆ **Risk register.** Described in Section 11.2.3.1. The risk register describes the individual risks that can impact resource selection and availability.

9.2.1.3 ENTERPRISE ENVIRONMENTAL FACTORS

The enterprise environmental factors that can influence the Estimate Activity Resources process include but are not limited to:

- ◆ Resource location,
- ◆ Resource availability,
- ◆ Team resource skills,
- ◆ Organizational culture,
- ◆ Published estimating data, and
- ◆ Marketplace conditions.

9.2.1.4 ORGANIZATIONAL PROCESS ASSETS

The organizational process assets that can influence the Estimate Activity Resources process include but are not limited to:

- ◆ Policies and procedures regarding staffing,
- ◆ Policies and procedures relating to supplies and equipment, and
- ◆ Historical information regarding types of resources used for similar work on previous projects.

9.2.2 ESTIMATE ACTIVITY RESOURCES: TOOLS AND TECHNIQUES

9.2.2.1 EXPERT JUDGMENT

Described in Section 4.1.2.1. Expertise should be considered from individuals or groups with specialized knowledge or training in team and physical resource planning and estimating.

9.2.2.2 BOTTOM-UP ESTIMATING

Described in Section 6.4.2.5. Team and physical resources are estimated at the activity level and then aggregated to develop the estimates for work packages, control accounts, and summary project levels.

9.2.2.3 ANALOGOUS ESTIMATING

Described in Section 6.4.2.2. Analogous estimating uses information regarding resources from a previous similar project as the basis for estimating a future project. It is used as quick estimating method and can be used when the project manager can only identify a few top levels of the WBS.

9.2.2.4 PARAMETRIC ESTIMATING

Described in Section 6.4.2.3. Parametric estimating uses an algorithm or a statistical relationship between historical data and other variables to calculate resource quantities needed for an activity, based on historical data and project parameters. For example, if an activity needs 4,000 hours of coding and it needs to finish it in 1 year, it will require two people to code (each doing 2,000 hours a year). This technique can produce higher levels of accuracy depending on the sophistication and underlying data built into the model.

9.2.2.5 DATA ANALYSIS

A data analysis technique used in this process includes but is not limited to alternatives analysis. Alternatives analysis is used to evaluate identified options in order to select the options or approaches to use to execute and perform the work of the project. Many activities have multiple options for accomplishment. They include using various levels of resource capability or skills, different sizes or types of machines, different tools (manual versus automated), and make-rent-or-buy decisions regarding the resources. Alternatives analysis assists in providing the best solution to perform the project activities, within the defined constraints.

9.2.2.6 PROJECT MANAGEMENT INFORMATION SYSTEM (PMIS)

Described in Section 4.3.2.2. Project management information systems can include resource management software that can help plan, organize, and manage resource pools and develop resource estimates. Depending on the sophistication of the software, resource breakdown structures, resource availability, resource rates, and various resource calendars can be defined to assist in optimizing resource utilization.

9.2.2.7 MEETINGS

The project manager may hold planning meetings with functional managers to estimate the resources needed per activity, level of effort (LoE), skill level of the team resources, and the quantity of the materials needed. Participants at these meetings may include the project manager, the project sponsor, selected project team members, selected stakeholders, and others as needed.

9.2.3 ESTIMATE ACTIVITY RESOURCES: OUTPUTS

9.2.3.1 RESOURCE REQUIREMENTS

Resource requirements identify the types and quantities of resources required for each work package or activity in a work package and can be aggregated to determine the estimated resources for each work package, each WBS branch, and the project as a whole. The amount of detail and the level of specificity of the resource requirement descriptions can vary by application area. The resource requirements' documentation can include assumptions that were made in determining which types of resources are applied, their availability, and what quantities are needed.

9.2.3.2 BASIS OF ESTIMATES

Described in Section 6.4.3.2. The amount and type of additional details supporting the resource estimate vary by application area. Regardless of the level of detail, the supporting documentation should provide a clear and complete understanding of how the resource estimate was derived.

Supporting detail for resource estimates may include:

- ◆ Method used to develop the estimate,
- ◆ Resources used to develop the estimate (such as information from previous similar projects),
- ◆ Assumptions associated with the estimate,
- ◆ Known constraints,
- ◆ Range of estimates,
- ◆ Confidence level of the estimate, and
- ◆ Documentation of identified risks influencing the estimate.

9.2.3.3 RESOURCE BREAKDOWN STRUCTURE

The resource breakdown structure is a hierarchical representation of resources by category and type (see Figure 9-7 for example). Examples of resource categories include but are not limited to labor, material, equipment, and supplies. Resource types may include the skill level, grade level, required certifications, or other information as appropriate to the project. In Plan Resource Management, the resource breakdown structure was used to guide the categorization for the project. In this process it is a completed document that will be used to acquire and monitor resources.

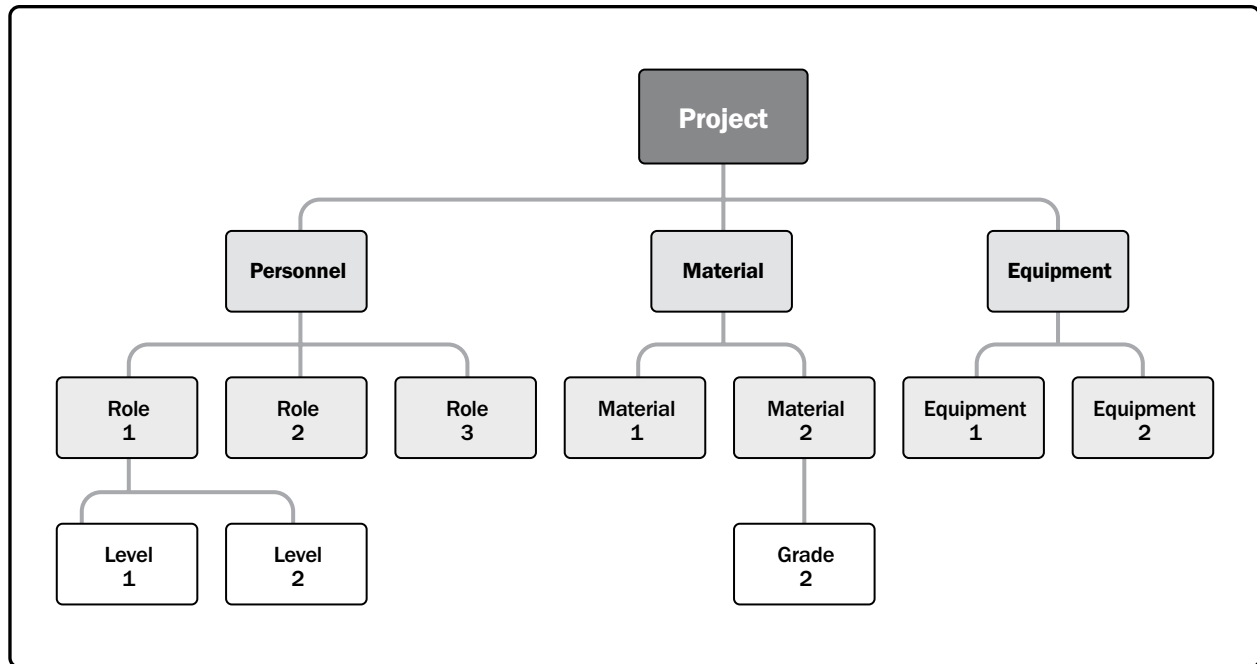

Figure 9-7. Sample Resource Breakdown Structure

9.2.3.4 PROJECT DOCUMENTS UPDATES

Project documents that may be updated as a result of carrying out this process include but are not limited to:

- ◆ **Activity attributes.** Described in Section 6.2.3.2. The activity attributes are updated with the resource requirements.
- ◆ **Assumption log.** Described in Section 4.1.3.2. The assumption log is updated with assumptions regarding the types and quantities of resources required. Additionally, any resource constraints are entered including collective bargaining agreements, continuous hours of operation, planned leave, etc.
- ◆ **Lessons learned register.** Described in Section 11.2.3.1. The lessons learned register can be updated with techniques that were efficient and effective in developing resource estimates, and information on those techniques that were not efficient or effective.

9.3 ACQUIRE RESOURCES

Acquire Resources is the process of obtaining team members, facilities, equipment, materials, supplies, and other resources necessary to complete project work. The key benefit of this process is that it outlines and guides the selection of resources and assigns them to their respective activities. This process is performed periodically throughout the project as needed. The inputs, tools and techniques, and outputs of the process are depicted in Figure 9-8. Figure 9-9 depicts the data flow diagram for the process.

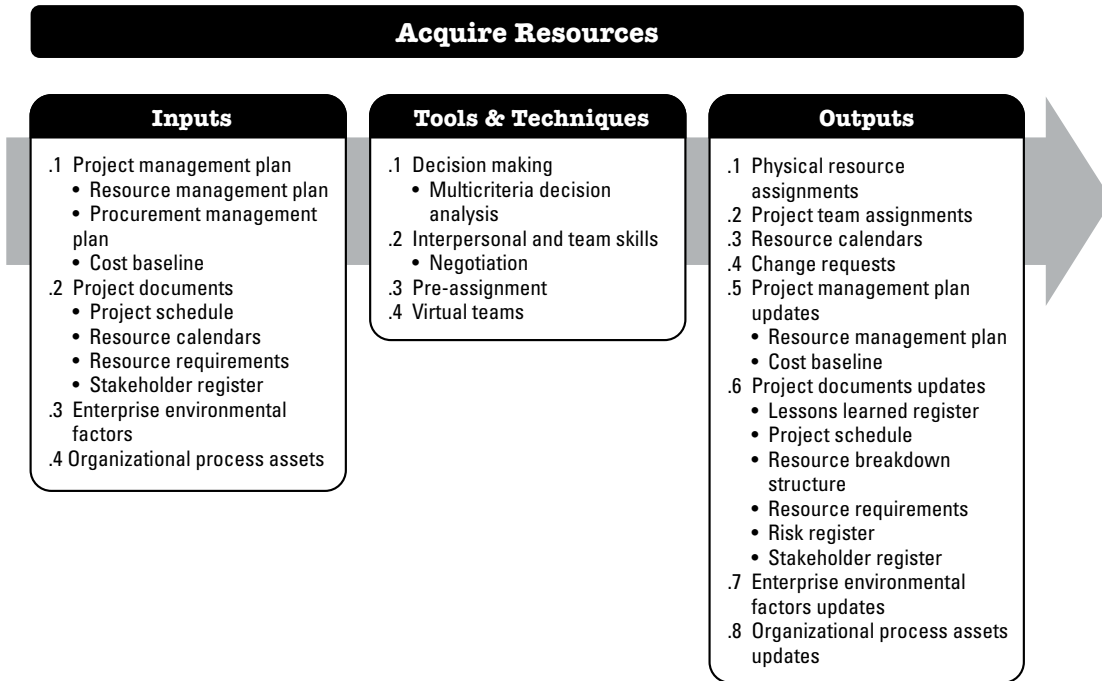

Figure 9-8. Acquire Resources: Inputs, Tools & Techniques, and Outputs

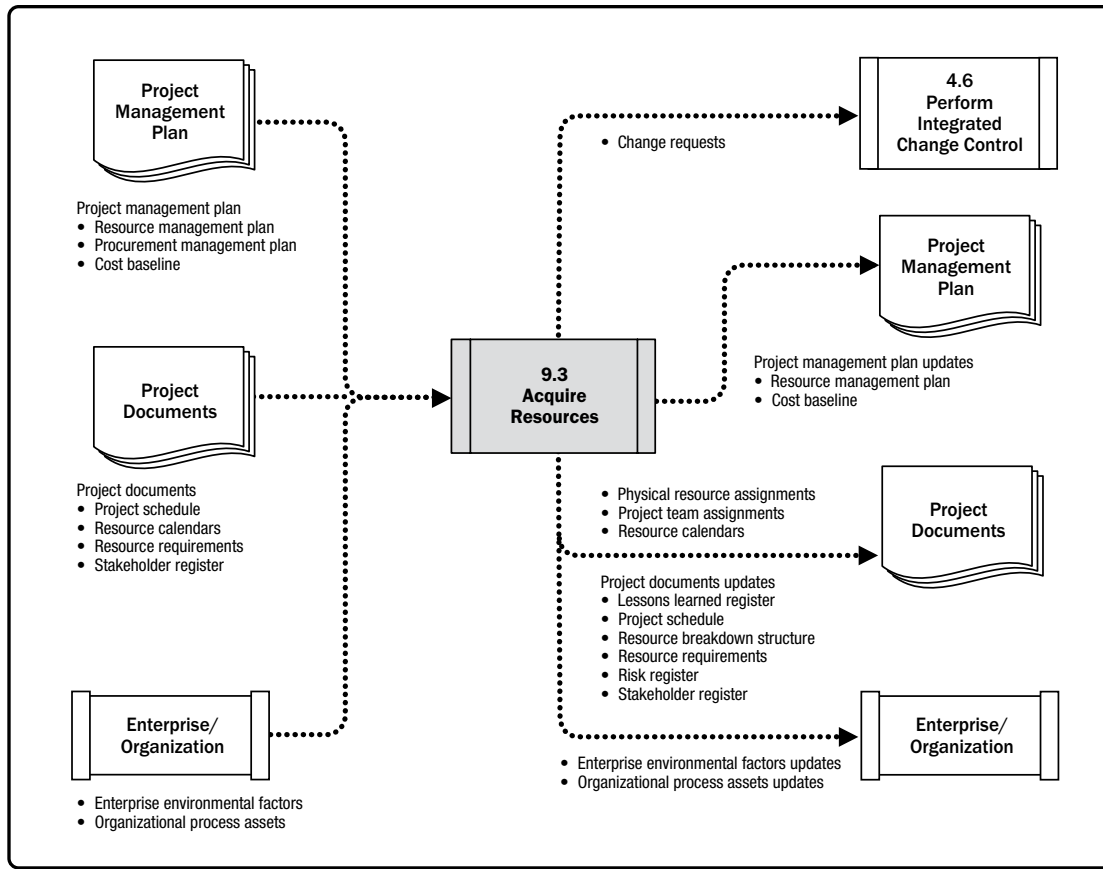

Figure 9-9. Acquire Resources: Data Flow Diagram

The resources needed for the project can be internal or external to the project-performing organization. Internal resources are acquired (assigned) from functional or resource managers. External resources are acquired through the procurement processes.

The project management team may or may not have direct control over resource selection because of collective bargaining agreements, use of subcontractor personnel, a matrix project environment, internal or external reporting relationships, or other reasons. It is important that the following factors are considered during the process of acquiring the project resources:

- ◆ The project manager or project team should effectively negotiate and influence others who are in a position to provide the required team and physical resources for the project.
- ◆ Failure to acquire the necessary resources for the project may affect project schedules, budgets, customer satisfaction, quality, and risks. Insufficient resources or capabilities decrease the probability of success and, in a worst-case scenario, could result in project cancellation.
- ◆ If the team resources are not available due to constraints such as economic factors or assignment to other projects, the project manager or project team may be required to assign alternative resources, perhaps with different competencies or costs. Alternative resources are allowed provided there is no violation of legal, regulatory, mandatory, or other specific criteria.

These factors should be considered and accounted for in the planning stages of the project. The project manager or project management team will be required to document the impact of the unavailability of required resources in the project schedule, project budget, project risks, project quality, training plans, and other project management plans.

9.3.1 ACQUIRE RESOURCES: INPUTS

9.3.1.1 PROJECT MANAGEMENT PLAN

Described in Section 4.2.3.1. Project management plan components include but are not limited to:

- ◆ **Resource management plan.** Described in Section 9.1.3.1. The resource management plan provides guidance on how to acquire resources for the project.
- ◆ **Procurement management plan.** Described in Section 12.1.3.1. The procurement management plan has information regarding resources that will be acquired from outside the project. This includes information on how procurements will be integrated with other project work and stakeholders involved in procuring resources.
- ◆ **Cost baseline.** Described in Section 7.3.3.1. The cost baseline provides the overall budget for the project activities.

9.3.1.2 PROJECT DOCUMENTS

Project documents that can be considered as inputs for this process include but are not limited to:

- ◆ **Project schedule.** Described in Section 6.5.3.2. The project schedule shows the activities and their planned start and end dates to help determine when the resources need to be available and acquired.
- ◆ **Resource calendars.** Described in Section 9.3.3.3. Resource calendars document the time periods that each resource needed for the project is available for the project. Creating a reliable schedule depends on having a good understanding of each resource's availability and schedule constraints, including time zones, work hours, vacation time, local holidays, maintenance schedule and commitments to other projects. Resource calendars are progressively elaborated and updated throughout the project. Once created as an output of this process, they are used as needed whenever this process is repeated.
- ◆ **Resource requirements.** Described in Section 9.2.3.1. Resource requirements identify which resources need to be acquired.
- ◆ **Stakeholder register.** Described in Section 13.1.3.1. The stakeholder register may reveal stakeholders' needs or expectations for specific resources to be used on the project that need to be considered in the Acquire Resources process.

9.3.1.3 ENTERPRISE ENVIRONMENTAL FACTORS

The enterprise environmental factors that can influence the Acquire Resources process include but are not limited to:

- ◆ Existing information on organizational resources including availability, competence levels, and prior experience for team resources and resource costs;
- ◆ Marketplace conditions;
- ◆ Organizational structure; and
- ◆ Geographic locations.

9.3.1.4 ORGANIZATIONAL PROCESS ASSETS

The organizational process assets that can influence the Acquire Resources process include but are not limited to:

- ◆ Policies and procedures for acquiring, allocating, and assigning resources to the project; and
- ◆ Historical information and lessons learned repository.

9.3.2 ACQUIRE RESOURCES: TOOLS AND TECHNIQUES

9.3.2.1 DECISION MAKING

Described in Section 5.2.2.4. Decision-making techniques that can be used in the Acquire Resources process include but are not limited to multicriteria decision analysis, as described in Section 8.1.2.4. Selection criteria are often used to select physical project resources, or the project team. Using a multicriteria decision analysis tool, criteria are developed and used to rate or score potential resources (for example, choosing between internal and external team resources). The criteria are weighted according to their relative importance and values can be changed for different types of resources. Some examples of selection criteria that can be used are:

- ◆ **Availability.** Verify that the resource is available to work on the project within the time period needed.
- ◆ **Cost.** Verify if the cost of adding the resource is within the prescribed budget.
- ◆ **Ability.** Verify that the team member provides the capability needed by the project.

Some selection criteria that are unique for team resources are:

- ◆ **Experience.** Verify that the team member has the relevant experience that will contribute to the project success.
- ◆ **Knowledge.** Consider if the team member has relevant knowledge of the customer, similar implemented projects, and nuances of the project environment.
- ◆ **Skills.** Determine if the team member has the relevant skills to use a project tool.
- ◆ **Attitude.** Determine if the team member has the ability to work with others as a cohesive team.
- ◆ **International factors.** Consider team member location, time zone, and communication capabilities.

9.3.2.2 INTERPERSONAL AND TEAM SKILLS

An interpersonal and team skill that can be used for this process includes but is not limited to negotiation. Described in Section 12.2.2.5. Many projects need to negotiate for required resources. The project management team may need to negotiate with:

- ◆ **Functional managers.** Ensure that the project receives the best resources possible in the required timeframe and until their responsibilities are complete.
- ◆ **Other project management teams within the performing organization.** Appropriately assign or share scarce or specialized resources.
- ◆ **External organizations and suppliers.** Provide appropriate, scarce, specialized, qualified, certified, or other specific team or physical resources. Special consideration should be given to external negotiating policies, practices, processes, guidelines, legal, and other such criteria.

The project management team's ability to influence others plays an important role in negotiating resource allocation, as does the politics of the organizations involved. For example, convincing a functional manager about the high visibility of the project may influence him or her to assign the best resources to this project over competing ones.

9.3.2.3 PRE-ASSIGNMENT

When physical or team resources for a project are determined in advance, they are considered pre-assigned. This situation can occur if the project is the result of specific resources being identified as part of a competitive proposal or if the project is dependent upon the expertise of particular persons. Pre-assignment might also include the team members who have already been assigned in Develop Project Charter Process or other processes before the initial Resource Management Plan has been completed.

9.3.2.4 VIRTUAL TEAMS

The use of virtual teams creates new possibilities when acquiring project team members. Virtual teams can be defined as groups of people with a shared goal who fulfill their roles with little or no time spent meeting face to face. The availability of communication technology such as email, audio conferencing, social media, web-based meetings, and video conferencing has made virtual teams feasible. The virtual team model makes it possible to:

- ◆ Form teams of people from the same organization who live in widespread geographic areas;
- ◆ Add special expertise to a project team even though the expert is not in the same geographic area;
- ◆ Incorporate employees who work from home offices;
- ◆ Form teams of people who work different shifts, hours, or days;
- ◆ Include people with mobility limitations or disabilities;
- ◆ Move forward with projects that would have been held or canceled due to travel expenses; and
- ◆ Save the expense of offices and all physical equipment needed for employees.

Communication planning becomes increasingly important in a virtual team environment. Additional time may be needed to set clear expectations, facilitate communications, develop protocols for resolving conflict, include people in decision making, understand cultural differences, and share credit in successes.

9.3.3 ACQUIRE RESOURCES: OUTPUTS

9.3.3.1 PHYSICAL RESOURCE ASSIGNMENTS

Documentation of the physical resource assignments records the material, equipment, supplies, locations, and other physical resources that will be used during the project.

9.3.3.2 PROJECT TEAM ASSIGNMENTS

Documentation of team assignments records the team members and their roles and responsibilities for the project. Documentation can include a project team directory and names inserted into the project management plan, such as the project organization charts and schedules.

9.3.3.3 RESOURCE CALENDARS

A resource calendar identifies the working days, shifts, start and end of normal business hours, weekends, and public holidays when each specific resource is available. Information on which resources (such as team resource, equipment, and material) are potentially available during a planned activity period is used for estimating resource utilization. Resource calendars also specify when and for how long identified team and physical resources will be available during the project. This information may be at the activity or project level. This includes consideration of attributes such as resource experience and/or skill level, as well as various geographical locations.

9.3.3.4 CHANGE REQUESTS

Described in Section 4.3.3.4. When changes occur as a result of carrying out the Acquire Resources process (for example, impacts to the schedule) or when recommended corrective or preventive actions impact any of the components of the project management plan or project documents, the project manager needs to submit a change request. Change requests are processed for review and disposition through the Perform Integrated Change Control process (Section 4.6).

9.3.3.5 PROJECT MANAGEMENT PLAN UPDATES

Any change to the project management plan goes through the organization's change control process via a change request. Components of the project management plan that may be updated as a result of carrying out this process include but are not limited to:

- ◆ **Resource management plan.** Described in Section 9.1.3.1. The resource management plan may be updated to reflect actual experience in acquiring resources for the project, including lessons learned in acquiring resources early in the project that will impact how resources are acquired later in the project.
- ◆ **Cost baseline.** Described in Section 7.3.3.1. The cost baseline may change as a result of the acquisition of resources for the project.

9.3.3.6 PROJECT DOCUMENTS UPDATES

Project documents that may be updated as a result of carrying out this process include but are not limited to:

- ◆ **Lessons learned register.** Described in Section 4.4.3.1. The lessons learned register is updated with information on challenges encountered and how they could have been avoided as well as approaches that worked well for acquiring resources.
- ◆ **Project schedule.** Described in Section 6.5.3.2. Changes to the project schedule may result from the availability of required resources.
- ◆ **Resource breakdown structure.** Described in Section 9.2.3.3. Resources acquired during this process are recorded in the resource breakdown structure.
- ◆ **Resource requirements.** Described in Section 9.2.3.1. Resource requirements documentation is updated to reflect resources acquired for the project.
- ◆ **Risk register.** Described in Section 11.2.3.1. New risks identified during this process are recorded in the risk register and managed using the risk management processes.
- ◆ **Stakeholder register.** Described in Section 13.1.3.1. The stakeholder register is updated with any new stakeholders and any new information about existing stakeholders that has been gained as a result of this process.

9.3.3.7 ENTERPRISE ENVIRONMENTAL FACTORS UPDATES

Enterprise environmental factors that are updated include but are not limited to:

- ◆ Resource availability within the organization, and
- ◆ Amount of the organization's consumable resources that have been used.

9.3.3.8 ORGANIZATIONAL PROCESS ASSETS UPDATES

Organizational process assets that are updated as a result of the Acquire Resources process include but are not limited to documentation related to acquiring, assigning and allocating resources.

9.4 DEVELOP TEAM

Develop Team is the process of improving competencies, team member interaction, and the overall team environment to enhance project performance. The key benefit of this process is that it results in improved teamwork, enhanced interpersonal skills and competencies, motivated employees, reduced attrition, and improved overall project performance. This process is performed throughout the project.

The inputs, tools and techniques, and outputs of the process are depicted in Figure 9-10. Figure 9-11 depicts the data flow diagram for the process.

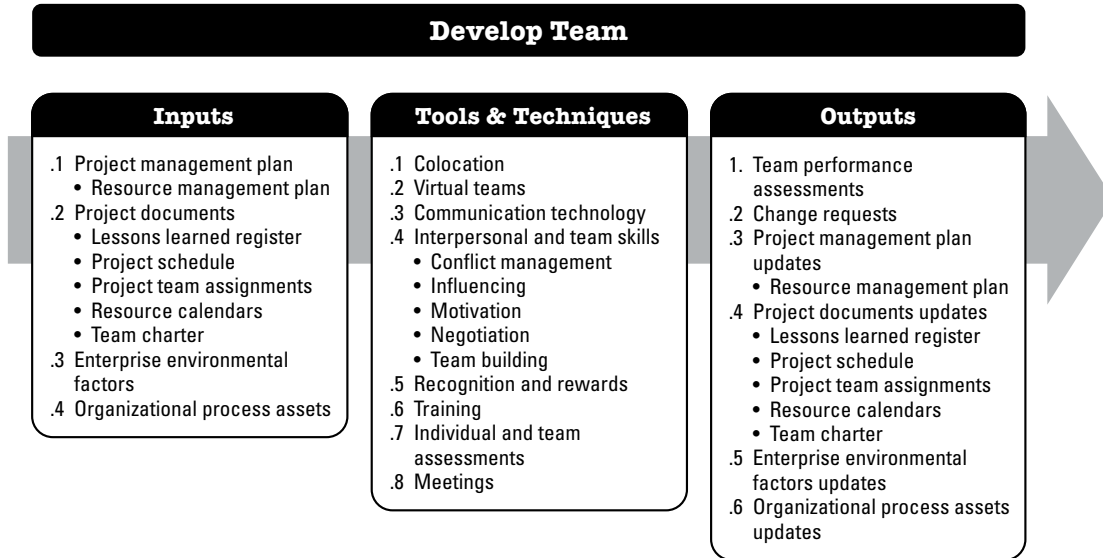

Figure 9-10. Develop Team: Inputs, Tools & Techniques, and Outputs

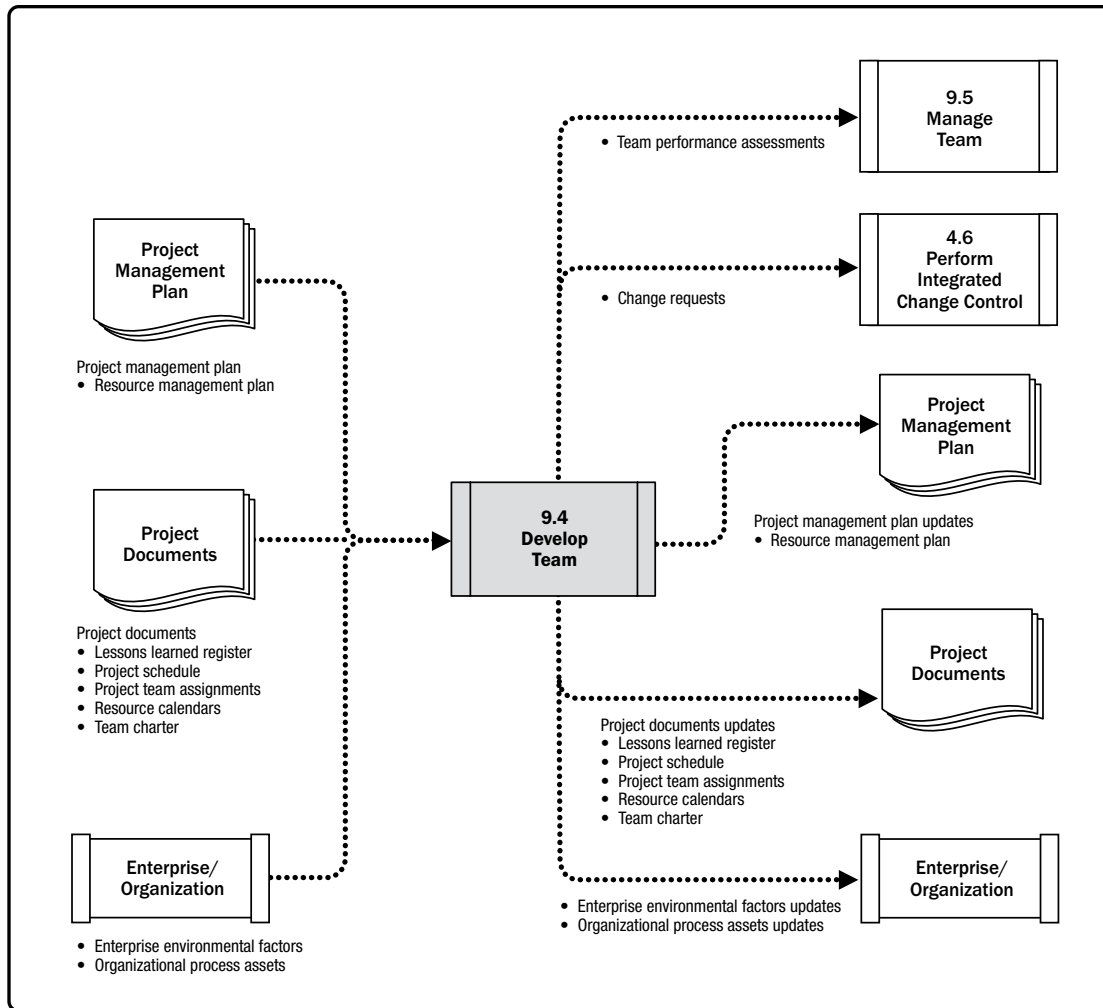

Figure 9-11. Develop Team: Data Flow Diagram

Project managers require the skills to identify, build, maintain, motivate, lead, and inspire project teams to achieve high team performance and to meet the project's objectives. Teamwork is a critical factor for project success, and developing effective project teams is one of the primary responsibilities of the project manager. Project managers should create an environment that facilitates teamwork and continually motivates the team by providing challenges and opportunities, providing timely feedback and support as needed, and recognizing and rewarding good performance. High team performance can be achieved by employing these behaviors:

- ◆ Using open and effective communication,
- ◆ Creating team-building opportunities,
- ◆ Developing trust among team members,
- ◆ Managing conflicts in a constructive manner,
- ◆ Encouraging collaborative problem solving, and
- ◆ Encouraging collaborative decision making.

Project managers operate in a global environment and work on projects characterized by cultural diversity. Team members often have diverse industry experience, communicate in multiple languages, and sometimes work with a “team language” or cultural norm that may be different from their native one. The project management team should capitalize on cultural differences, focus on developing and sustaining the project team throughout the project life cycle, and promote working together interdependently in a climate of mutual trust. Developing the project team improves the people skills, technical competencies, and overall team environment and project performance. It requires clear, timely, effective, and efficient communication between team members throughout the life of the project. Objectives of developing a project team include but are not limited to:

- ◆ Improving the knowledge and skills of team members to increase their ability to complete project deliverables, while lowering costs, reducing schedules, and improving quality;
- ◆ Improving feelings of trust and agreement among team members to raise morale, lower conflict, and increase teamwork;
- ◆ Creating a dynamic, cohesive, and collaborative team culture to: (1) improve individual and team productivity, team spirit, and cooperation; and (2) allow cross-training and mentoring between team members to share knowledge and expertise; and
- ◆ Empowering the team to participate in decision making and take ownership of the provided solutions to improve team productivity for more effective and efficient results.

One of the models used to describe team development is the Tuckman ladder [19, 20], which includes five stages of development that teams may go through. Although it is common for these stages to occur in order, it is not uncommon for a team to get stuck in a particular stage or regress to an earlier stage. Projects with team members who worked together in the past might skip a stage.

- ◆ **Forming.** This phase is where the team members meet and learn about the project and their formal roles and responsibilities. Team members tend to be independent and not as open in this phase.
- ◆ **Storming.** During this phase, the team begins to address the project work, technical decisions, and the project management approach. If team members are not collaborative or open to differing ideas and perspectives, the environment can become counterproductive.
- ◆ **Norming.** In this phase, team members begin to work together and adjust their work habits and behaviors to support the team. The team members learn to trust each other.
- ◆ **Performing.** Teams that reach the performing stage function as a well-organized unit. They are interdependent and work through issues smoothly and effectively.
- ◆ **Adjourning.** In this phase, the team completes the work and moves on from the project. This typically occurs when staff is released from the project as deliverables are completed or as part of the Close Project or Phase process.

The duration of a particular stage depends upon team dynamics, team size, and team leadership. Project managers should have a good understanding of team dynamics in order to move their team members through all stages in an effective manner.

9.4.1 DEVELOP TEAM: INPUTS

9.4.1.1 PROJECT MANAGEMENT PLAN

Described in Section 4.2.3.1. Project management plan components include but are not limited to the resource management plan. Described in Section 9.1.3.1, the resource management plan provides guidance on providing project team member rewards, feedback, additional training, and disciplinary actions as a result of team performance assessments and other forms of project team management. The resource management plan may include also the team performance assessment criteria.

9.4.1.2 PROJECT DOCUMENTS

Project documents that can be considered as inputs for this process include but are not limited to:

- ◆ **Lessons learned register.** Described in Section 4.4.3.1. Lessons learned earlier in the project with regard to developing the team can be applied to later phases in the project to improve team performance.
- ◆ **Project schedule.** Described in Section 6.5.3.2. The project schedule defines how and when to provide training to the project team and develop the competencies required at different phases. It identifies the need for team development strategies based on variations, if any, during the project execution.
- ◆ **Project team assignments.** Described in Section 9.3.3.1. Project team assignments identify the team and member roles and responsibilities.
- ◆ **Resource calendars.** Described in Section 9.2.1.2. Resource calendars identify times when the project team members can participate in team development activities. It also helps illustrate team availability during the entire project.
- ◆ **Team charter.** Described in Section 9.1.3.2. The team charter is where the team operating guidelines are documented. The team values and operating guidelines provide the structure that describes how the team will operate together.

9.4.1.3 ENTERPRISE ENVIRONMENTAL FACTORS

The enterprise environmental factors that can influence the Develop Team process include but are not limited to:

- ◆ Human resource management policies regarding hiring and termination, employee performance reviews, employee development and training records, and recognition and rewards;
- ◆ Team member skills, competencies, and specialized knowledge; and
- ◆ Geographic distribution of team members.

9.4.1.4 ORGANIZATIONAL PROCESS ASSETS

The organizational process assets that can influence the Develop Team process include but are not limited to historical information and the lessons learned repository.

9.4.2 DEVELOP TEAM: TOOLS AND TECHNIQUES

9.4.2.1 COLOCATION

Colocation involves placing many or all of the most active project team members in the same physical location to enhance their ability to perform as a team. Colocation can be temporary, such as at strategically important times during the project, or can continue for the entire project. Colocation strategies can include a team meeting room, common places to post schedules, and other conveniences that enhance communication and a sense of community.

9.4.2.2 VIRTUAL TEAMS

The use of virtual teams can bring benefits such as the use of more skilled resources, reduced costs, less travel and relocation expenses, and the proximity of team members to suppliers, customers, or other key stakeholders. Virtual teams can use technology to create an online team environment where the team can store files, use conversations threads to discuss issues, and keep a team calendar.

9.4.2.3 COMMUNICATION TECHNOLOGY

Described in Section 10.1.2.3. Communication technology is important in addressing the team development issues in collocated and virtual teams. It helps build a harmonious environment for the collocated team and a better understanding for the virtual team, especially those working in different time zones. Examples of communication technology that may be used are:

- ◆ **Shared portal.** A shared repository for information sharing (e.g., website, collaboration software or intranet) is effective for virtual project teams.
- ◆ **Video conferencing.** Video conferencing is an important technique for effective communication with virtual teams.
- ◆ **Audio conferencing.** Communication within a team using audio conferencing is another technique to build rapport and confidence within virtual teams.
- ◆ **Email/chat.** Regular communications using email and chat is also an effective technique.

9.4.2.4 INTERPERSONAL AND TEAM SKILLS

Interpersonal and team skills that can be used for this process include but are not limited to:

- ◆ **Conflict management.** Described in Section 9.5.2.1. The project manager needs to resolve conflicts in a timely manner and in a constructive way in order to achieve a high-performing team.
- ◆ **Influencing.** Described in Section 9.5.2.1. An influencing skill used in this process is gathering relevant and critical information to address important issues and reach agreements while maintaining mutual trust.
- ◆ **Motivation.** Motivation is providing a reason for someone to act. Teams are motivated by empowering them to participate in decision making and encouraging them to work independently.
- ◆ **Negotiation.** Described in Section 12.2.2.5. Negotiation among team members is used to reach consensus on project needs. Negotiation can build trust and harmony among the team members.
- ◆ **Team building.** Team building is conducting activities that enhance the team's social relations and build a collaborative and cooperative working environment. Team building activities can vary from a 5-minute agenda item in a status review meeting to an offsite, professionally facilitated event designed to improve interpersonal relationships. The objective of team-building activities is to help individual team members work together effectively. Team-building strategies are particularly valuable when team members operate from remote locations without the benefit of face-to-face contact. Informal communication and activities can help in building trust and establishing good working relationships. While team building is essential during the initial stages of a project, it should be a continuous process. Changes in a project environment are inevitable, and to manage them effectively, a continuous or renewed team-building effort may be applied. The project manager should continually monitor team functionality and performance to determine if any actions are needed to prevent or correct various team problems.

9.4.2.5 RECOGNITION AND REWARDS

Part of the team development process involves recognizing and rewarding desirable behavior. The original plan for rewarding people is developed during the Plan Resource Management process. Rewards will be effective only if they satisfy a need that is valued by that individual. Reward decisions are made, formally or informally, during the process of managing the project team. Cultural differences should be considered when determining recognition and rewards.

People are motivated when they feel they are valued in the organization and this value is demonstrated by the rewards given to them. Generally, money is viewed as a tangible aspect of any reward system, but intangible rewards could be equally or even more effective. Most project team members are motivated by an opportunity to grow, accomplish, be appreciated, and apply their professional skills to meet new challenges. A good strategy for project managers is to give the team recognition throughout the life cycle of the project rather than waiting until the project is completed.

9.4.2.6 TRAINING

Training includes all activities designed to enhance the competencies of the project team members. Training can be formal or informal. Examples of training methods include classroom, online, computer-based, on-the-job training from another project team member, mentoring, and coaching. If project team members lack the necessary management or technical skills, such skills can be developed as part of the project work. Scheduled training takes place as stated in the resource management plan. Unplanned training takes place as a result of observation, conversation, and project performance appraisals conducted during management of the project team. Training costs could be included in the project budget or supported by the performing organization if the added skills may be useful for future projects. It may be performed by in-house or by external trainers.

9.4.2.7 INDIVIDUAL AND TEAM ASSESSMENTS

Individual and team assessment tools give the project manager and the project team insight into areas of strengths and weaknesses. These tools help project managers assess team members' preferences, aspirations, how they process and organize information, how they make decisions, and how they interact with people. Various tools are available such as attitudinal surveys, specific assessments, structured interviews, ability tests, and focus groups. These tools can provide improved understanding, trust, commitment, and communications among team members and facilitate more productive teams throughout the project.

9.4.2.8 MEETINGS

Meetings are used to discuss and address pertinent topics for developing the team. Attendees include the project manager and the project team. Types of meetings include but are not limited to project orientation meetings, team-building meetings, and team development meetings.

9.4.3 DEVELOP TEAM: OUTPUTS

9.4.3.1 TEAM PERFORMANCE ASSESSMENTS

As project team development efforts such as training, team building, and colocation are implemented, the project management team makes formal or informal assessments of the project team's effectiveness. Effective team development strategies and activities are expected to increase the team's performance, which increases the likelihood of meeting project objectives.

The evaluation of a team's effectiveness may include indicators such as:

- ◆ Improvements in skills that allow individuals to perform assignments more effectively,
- ◆ Improvements in competencies that help team members perform better as a team,
- ◆ Reduced staff turnover rate, and
- ◆ Increased team cohesiveness where team members share information and experiences openly and help each other to improve the overall project performance.

As a result of conducting an evaluation of the team's overall performance, the project management team can identify the specific training, coaching, mentoring, assistance, or changes required to improve the team's performance. This should also include identifying the appropriate or required resources necessary to achieve and implement the improvements identified in the assessment.

9.4.3.2 CHANGE REQUESTS

Described in Section 4.3.3.4. If change requests occur as a result of carrying out the Develop Team process or if recommended corrective or preventive actions impact any of the components of the project management plan or project documents, the project manager needs to submit a change request and follow the Perform Integrated Change Control process as defined in Section 4.6.

9.4.3.3 PROJECT MANAGEMENT PLAN UPDATES

Any change to the project management plan goes through the organization's change control process via a change request. Components that may require a change request for the project management plan include but are not limited to the resource management plan, as described in Section 9.1.3.1.

9.4.3.4 PROJECT DOCUMENTS UPDATES

Project documents that may be updated as a result of carrying out this process include but are not limited to:

- ◆ **Lessons learned register.** Described in Section 4.4.3.1. The lessons learned register is updated with information on challenges encountered and how they could have been avoided as well as approaches that worked well for the development of the team.
- ◆ **Project schedule.** Described in Section 6.5.3.2. Activities to develop the project team may result in changes to the project schedule.
- ◆ **Project team assignments.** Described in Section 9.3.3.1. When team development results in changes to agreed-upon assignments, these changes are recorded in the project team assignments documentation.
- ◆ **Resource calendars.** Described in Section 9.2.1.2. Resource calendars are updated to reflect the availability of resources for the project.
- ◆ **Team charter.** Described in Section 9.1.3.2. The team charter may be updated to reflect changes to agreed-upon team operating guidelines that result from team development.

9.4.3.5 ENTERPRISE ENVIRONMENTAL FACTORS UPDATES

Enterprise environmental factors that are updated as a result of the Develop Project Team process include but are not limited to:

- ◆ Employee development plan records, and
- ◆ Skill assessments.

9.4.3.6 ORGANIZATIONAL PROCESS ASSETS UPDATES

Organizational process assets that are updated as a result of the Develop Team process include but are not limited to:

- ◆ Training requirements, and
- ◆ Personnel assessment.

9.5 MANAGE TEAM

Manage Team is the process of tracking team member performance, providing feedback, resolving issues, and managing team changes to optimize project performance. The key benefit of this process is that it influences team behavior, manages conflict, and resolves issues. This process is performed throughout the project.

The inputs, tools and techniques, and outputs of the process are depicted in Figure 9-12. Figure 9-13 depicts the data flow diagram for the process.

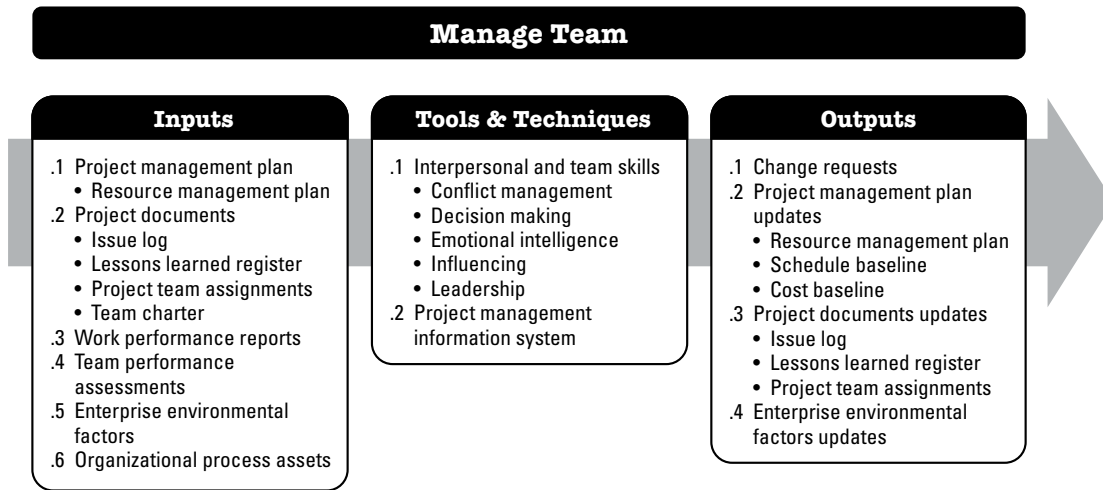

Figure 9-12. Manage Team: Inputs, Tools & Techniques, and Outputs

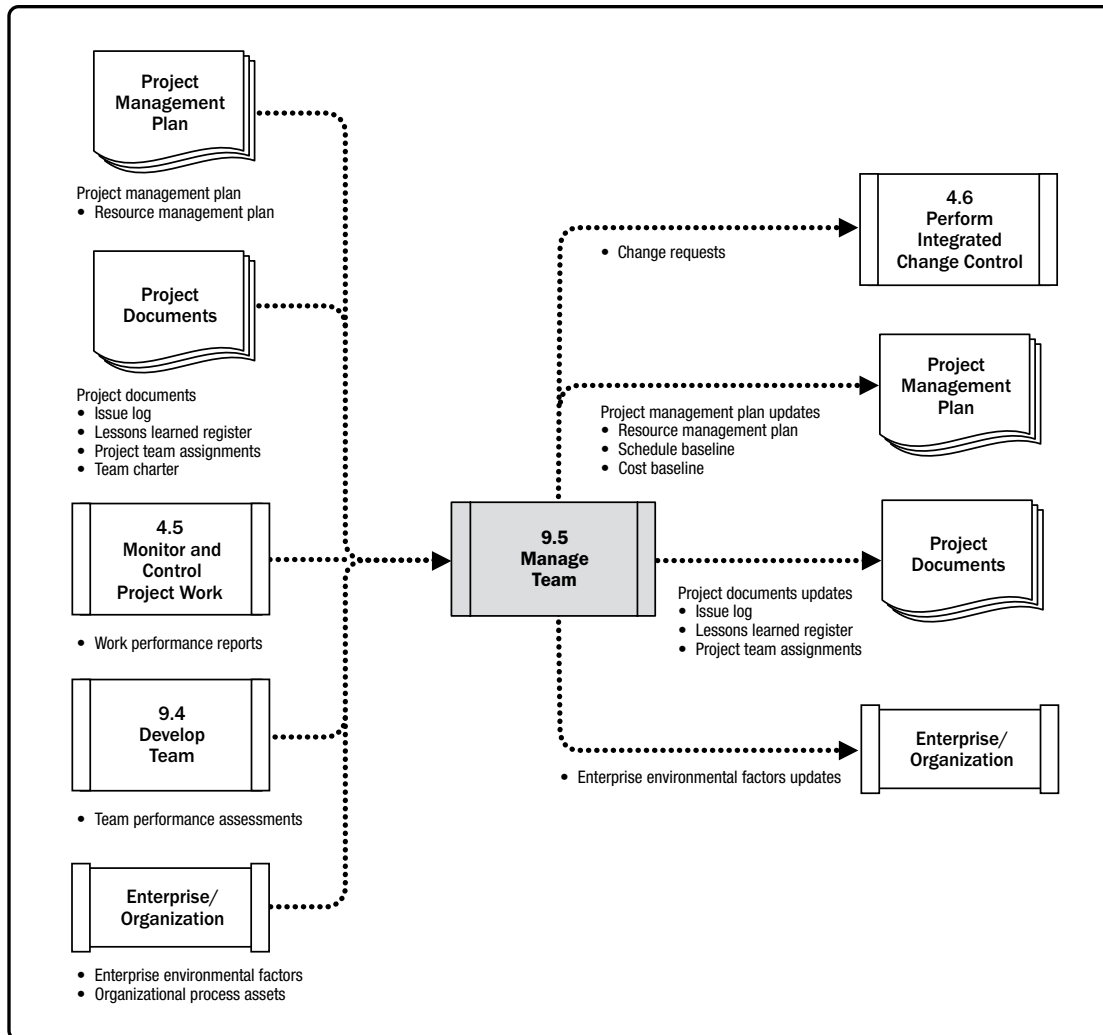

Figure 9-13. Manage Team: Data Flow Diagram

Managing the project team requires a variety of management and leadership skills for fostering teamwork and integrating the efforts of team members to create high-performance teams. Team management involves a combination of skills with special emphasis on communication, conflict management, negotiation, and leadership. Project managers should provide challenging assignments to team members and provide recognition for high performance.

The project manager needs to be sensitive to both the willingness and the ability of team members to perform their work and adjust their management and leadership styles accordingly. Team members with low-skill abilities will require more intensive oversight than those who have demonstrated ability and experience.

9.5.1 MANAGE TEAM: INPUTS

9.5.1.1 PROJECT MANAGEMENT PLAN

Described in Section 4.2.3.1. Project management plan components include but are not limited to the resource management plan. Described in Section 9.1.3.1, the resource management plan provides guidance on how project team resources should be managed and eventually released.

9.5.1.2 PROJECT DOCUMENTS

Project documents that can be considered as inputs for this process include but are not limited to:

- ◆ **Issue log.** Described in Section 4.3.3.3. Issues arise in the course of managing the project team. An issue log can be used to document and monitor who is responsible for resolving specific issues by a target date.
- ◆ **Lessons learned register.** Described in Section 4.4.3.1. Lessons learned earlier in the project can be applied to later phases in the project to improve the efficiency and effectiveness of managing the team.
- ◆ **Project team assignments.** Described in Section 9.3.3.1. Project team assignments identify the team member roles and responsibilities.
- ◆ **Team charter.** Described in Section 9.1.3.2. The team charter provides guidance for how the team will make decisions, conduct meetings, and resolve conflict.

9.5.1.3 WORK PERFORMANCE REPORTS

Described in Section 4.5.3.1. Work performance reports are the physical or electronic representation of work performance information intended to generate decisions, actions, or awareness. Performance reports that can help with project team management include results from schedule control, cost control, quality control, and scope validation. The information from performance reports and related forecasts assists in determining future team resource requirements, recognition and rewards, and updates to the resource management plan.

9.5.1.4 TEAM PERFORMANCE ASSESSMENTS

Described in Section 9.4.3.1. The project management team makes ongoing formal or informal assessments of the project team's performance. By continually assessing the project team's performance, actions can be taken to resolve issues, modify communication, address conflict, and improve team interaction.

9.5.1.5 ENTERPRISE ENVIRONMENTAL FACTORS

The enterprise environmental factors that can influence the Manage Team process include but are not limited to human resource management policies.

9.5.1.6 ORGANIZATIONAL PROCESS ASSETS

The organizational process assets that can influence the Manage Team process include but are not limited to:

- ◆ Certificates of appreciation,
- ◆ Corporate apparel, and
- ◆ Other organizational perquisites.

9.5.2 MANAGE TEAM: TOOLS AND TECHNIQUES

9.5.2.1 INTERPERSONAL AND TEAM SKILLS

Interpersonal and team skills that can be used for this process include but are not limited to:

- ◆ **Conflict management.** Conflict is inevitable in a project environment. Sources of conflict include scarce resources, scheduling priorities, and personal work styles. Team ground rules, group norms, and solid project management practices, like communication planning and role definition, reduce the amount of conflict.

Successful conflict management results in greater productivity and positive working relationships. When managed properly, differences of opinion can lead to increased creativity and better decision making. If the differences become a negative factor, project team members are initially responsible for their resolution. If conflict escalates, the project manager should help facilitate a satisfactory resolution. Conflict should be addressed early and usually in private, using a direct, collaborative approach. If disruptive conflict continues, formal procedures may be used, including disciplinary actions.

The success of project managers in managing their project teams often depends on their ability to resolve conflict. Different project managers may use different conflict resolution methods. Factors that influence conflict resolution methods include:

- Importance and intensity of the conflict,
- Time pressure for resolving the conflict,
- Relative power of the people involved in the conflict,
- Importance of maintaining a good relationship, and
- Motivation to resolve conflict on a long-term or short-term basis.

There are five general techniques for resolving conflict. Each technique has its place and use:

- *Withdraw/avoid*. Retreating from an actual or potential conflict situation; postponing the issue to be better prepared or to be resolved by others.
 - *Smooth/accommodate*. Emphasizing areas of agreement rather than areas of difference; conceding one's position to the needs of others to maintain harmony and relationships.
 - *Compromise/reconcile*. Searching for solutions that bring some degree of satisfaction to all parties in order to temporarily or partially resolve the conflict. This approach occasionally results in a lose-lose situation.
 - *Force/direct*. Pushing one's viewpoint at the expense of others; offering only win-lose solutions, usually enforced through a power position to resolve an emergency. This approach often results to a win-lose situation.
 - *Collaborate/problem solve*. Incorporating multiple viewpoints and insights from differing perspectives; requires a cooperative attitude and open dialogue that typically leads to consensus and commitment. This approach can result in a win-win situation.
- ◆ **Decision making.** Decision making, in this context, involves the ability to negotiate and influence the organization and the project management team, rather than the set of tools described in the decision making tool set. Some guidelines for decision making include:
- Focus on goals to be served,
 - Follow a decision-making process,
 - Study the environmental factors,
 - Analyze available information,
 - Stimulate team creativity, and
 - Account for risk.
- ◆ **Emotional intelligence.** Emotional intelligence is the ability to identify, assess, and manage the personal emotions of oneself and other people, as well as the collective emotions of groups of people. The team can use emotional intelligence to reduce tension and increase cooperation by identifying, assessing, and controlling the sentiments of project team members, anticipating their actions, acknowledging their concerns, and following up on their issues.

- ◆ **Influencing.** Because project managers often have little or no direct authority over team members in a matrix environment, their ability to influence stakeholders on a timely basis is critical to project success. Key influencing skills include:
 - Ability to be persuasive;
 - Clearly articulating points and positions;
 - High levels of active and effective listening skills;
 - Awareness of, and consideration for, the various perspectives in any situation; and
 - Gathering relevant information to address issues and reach agreements while maintaining mutual trust.
- ◆ **Leadership.** Successful projects require leaders with strong leadership skills. Leadership is the ability to lead a team and inspire them to do their jobs well. It encompasses a wide range of skills, abilities and actions. Leadership is important through all phases of the project life cycle. There are multiple leadership theories defining leadership styles that should be used as needed for each situation or team. It is especially important to communicate the vision and inspire the project team to achieve high performance.

9.5.2.2 PROJECT MANAGEMENT INFORMATION SYSTEM (PMIS)

Described in Section 4.3.2.2. Project management information systems can include resource management or scheduling software that can be used for managing and coordinating team members across project activities.

9.5.3 MANAGE TEAM: OUTPUTS

9.5.3.1 CHANGE REQUESTS

Described in Section 4.3.3.4. When change requests occur as a result of carrying out the Manage Team process or when recommended corrective or preventive actions impact any of the components of the project management plan or project documents, the project manager needs to submit a change request. Change requests are processed for review and disposition through the Perform Integrated Change Control process (Section 4.6).

For example, staffing changes, whether made by choice or by uncontrollable events, can disrupt the project team. This disruption can cause the schedule to slip or the budget to be exceeded. Staffing changes include moving people to different assignments, outsourcing some of the work, or replacing team members who leave.

9.5.3.2 PROJECT MANAGEMENT PLAN UPDATES

Any change to the project management plan goes through the organization's change control process via a change request. Components of the project management plan that may require a change request for the project management plan include but are not limited to:

- ◆ **Resource management plan.** Described in Section 9.1.3.1. The resource management plan is updated to reflect actual experience in managing the project team.
- ◆ **Schedule baseline.** Described in Section 6.5.3.1. Changes to the project schedule may be required to reflect the way the team is performing.
- ◆ **Cost baseline.** Described in Section 7.3.3.1. Changes to the project cost baseline may be required to reflect the way the team is performing.

9.5.3.3 PROJECT DOCUMENTS UPDATES

Project documents that may be updated as a result of carrying out this process include but are not limited to:

- ◆ **Issue log.** Described in Section 4.3.3.3. New issues raised as a result of this process are recorded in the issue log.
- ◆ **Lessons learned register.** Described in Section 4.4.3.1. The lessons learned register is updated with information on challenges encountered and how they could have been avoided as well as approaches that worked well for the managing the team.
- ◆ **Project team assignments.** Described in Section 9.3.3.1. If changes to the team are required, those changes are recorded in the project team assignments documentation.

9.5.3.4 ENTERPRISE ENVIRONMENTAL FACTORS UPDATES

Enterprise environmental factors that are updated as a result of the Manage Team process include but are not limited to:

- ◆ Input to organizational performance appraisals, and
- ◆ Personnel skill.



9.6 CONTROL RESOURCES

Control Resources is the process of ensuring that the physical resources assigned and allocated to the project are available as planned, as well as monitoring the planned versus actual utilization of resources and taking corrective action as necessary. The key benefit of this process is ensuring that the assigned resources are available to the project at the right time and in the right place and are released when no longer needed. This process is performed throughout the project. The inputs and outputs of this process are depicted in Figure 9-14. Figure 9-15 depicts the data flow diagram for the process.

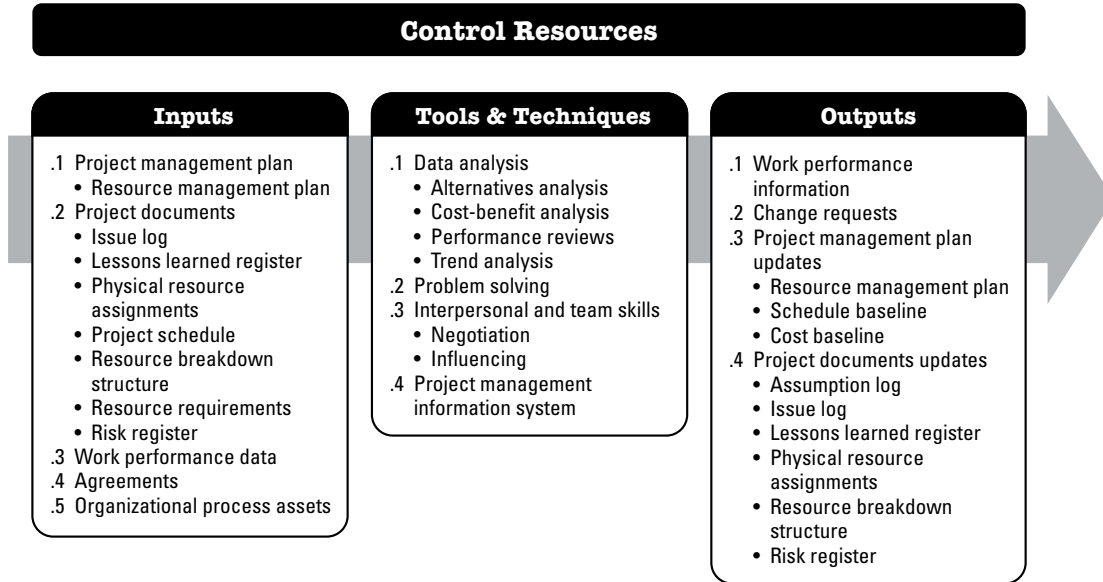

Figure 9-14. Control Resources: Inputs, Tools & Techniques, and Outputs

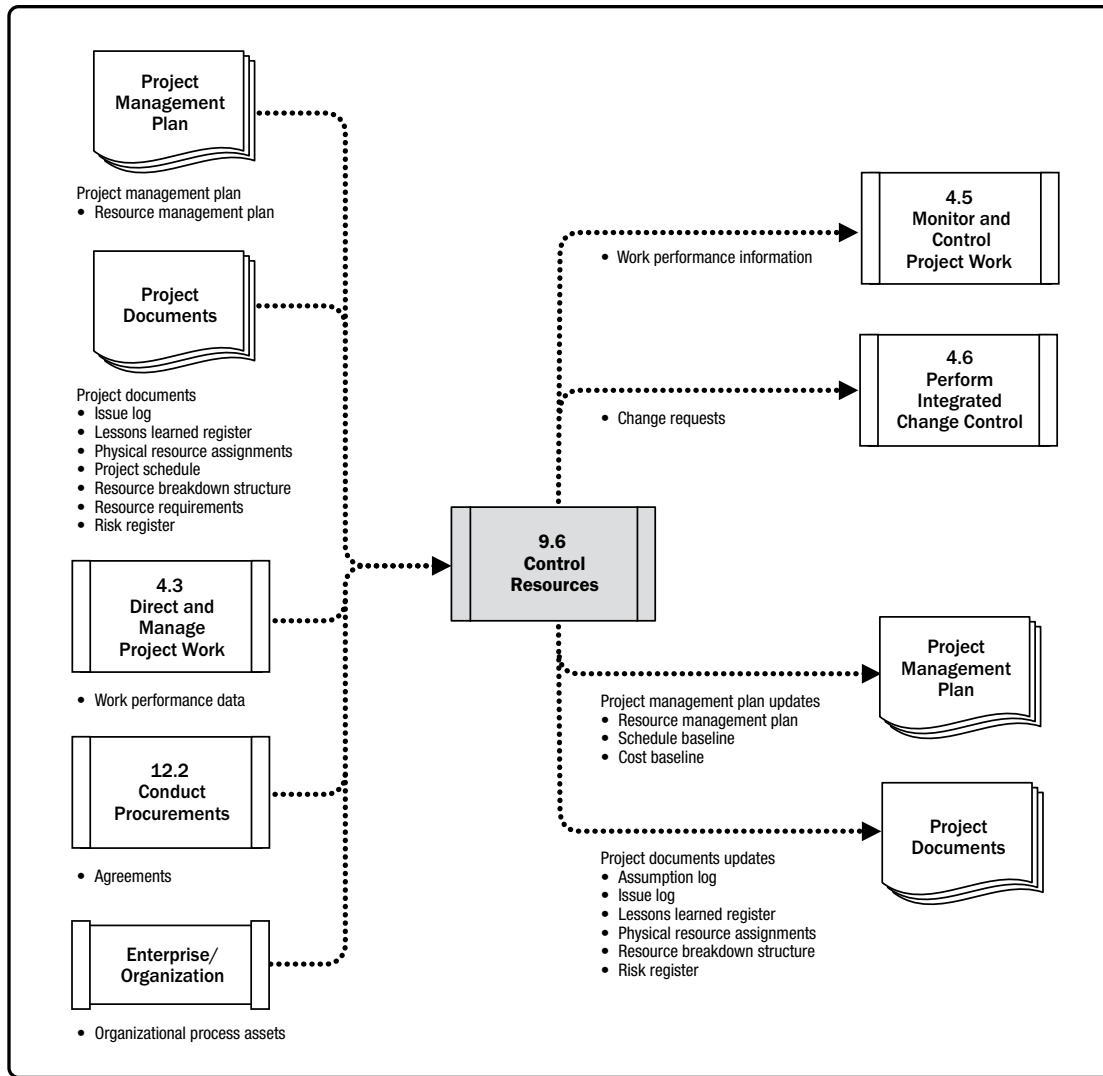

Figure 9-15. Control Resources: Data Flow Diagram

The Control Resources process should be performed continuously in all project phases and throughout the project life cycle. The resources needed for the project should be assigned and released at the right time, right place, and right amount for the project to continue without delays. The Control Resources process is concerned with physical resources such as equipment, materials, facilities, and infrastructure. Team members are addressed in the Manage Team process.

The Control Resources techniques discussed here are those used most frequently on projects. There are many others that may be useful on certain projects or in some application areas.

Updating resource allocation requires knowing what actual resources have been used to date and what is still needed. This is done mainly by reviewing the performance usage to date. Control Resources is concerned with:

- ◆ Monitoring resource expenditures,
- ◆ Identifying and dealing with resource shortage/surplus in a timely manner,
- ◆ Ensuring that resources are used and released according to the plan and project needs,
- ◆ Informing appropriate stakeholders if any issues arise with relevant resources,
- ◆ Influencing the factors that can create resources utilization change, and
- ◆ Managing the actual changes as they occur.

Any changes needed to the schedule or cost baselines can be approved only through the Perform Integrated Change Control process (Section 4.6).

9.6.1 CONTROL RESOURCES: INPUTS

9.6.1.1 PROJECT MANAGEMENT PLAN

Described in Section 4.2.3.1. Project management plan components include but are not limited to the resource management plan. Described in Section 9.1.3.1, the resource management plan provides guidance on how physical resources should be used, controlled, and eventually released.

9.6.1.2 PROJECT DOCUMENTS

Project documents that can be considered as inputs for this process include but are not limited to:

- ◆ **Issue log.** Described in Section 4.3.3.3. The issue log is used to identify issues such as lack of resources, delays in raw material supplies, or low grades of raw material.
- ◆ **Lessons learned register.** Described in Section 4.4.3.1. Lessons learned earlier in the project can be applied to later phases in the project to improve physical resource control.
- ◆ **Physical resource assignments.** Described in Section 9.3.3.1. The physical resource assignments describe the expected resource utilization along with details such as type, amount, location, and whether the resource is internal to the organization or outsourced.

- ◆ **Project schedule.** Described in Section 6.5.3.2. The project schedule shows the resources that are needed, when they are needed, and the location where they are needed.
- ◆ **Resource breakdown structure.** Described in Section 9.2.3.3. The resource breakdown structure provides a reference in case any resource needs to be replaced or reacquired during the course of the project.
- ◆ **Resource requirements.** Described in Section 9.2.3.1. Resource requirements identify the needed material, equipment, supplies, and other resources.
- ◆ **Risk register.** Described in Section 11.2.3.1. The risk register identifies individual risks that can impact equipment, materials, or supplies.

9.6.1.3 WORK PERFORMANCE DATA

Described in Section 4.3.3.2. Work performance data contains data on project status such as the number and type of resources that have been used.

9.6.1.4 AGREEMENTS

Described in Section 12.2.3.2. Agreements made within the context of the project are the basis for all resources external to the organization and should define procedures when new, unplanned resources are needed or when issues arise with the current resources.

9.6.1.5 ORGANIZATIONAL PROCESS ASSETS

The organizational process assets that can influence the Control Resources process include but are not limited to:

- ◆ Policies regarding resource control and assignment,
- ◆ Escalation procedures for handling issues within the performing organization, and
- ◆ Lessons learned repository from previous similar projects.



9.6.2 CONTROL RESOURCES: TOOLS AND TECHNIQUES

9.6.2.1 DATA ANALYSIS

Data analysis techniques that can be used in this process include but are not limited to:

- ◆ **Alternatives analysis.** Described in Section 9.2.2.5. Alternatives can be analyzed to select the best resolution for correcting variances in resource utilization. Alternatives such as paying additional for overtime or additional team resources can be weighed against a late delivery or phased deliveries.
- ◆ **Cost-benefit analysis.** Described in Section 8.1.2.3. This analysis helps to determine the best corrective action in terms of cost in case of project deviations.
- ◆ **Performance reviews.** Performance reviews measure, compare, and analyze planned resource utilization to actual resource utilization. Cost and schedule work performance information can also be analyzed to help pinpoint issues that can influence resource utilization.
- ◆ **Trend analysis.** Described in Section 4.5.2.2. As the project progresses, the project team may use trend analysis, based on current performance information, to determine the resources needed at upcoming stages of the project. Trend analysis examines project performance over time and can be used to determine whether performance is improving or deteriorating.

9.6.2.2 PROBLEM SOLVING

Described in Section 8.2.2.7. Problem solving may use a set of tools that helps the project manager to solve problems that arise during the control resource process. The problem can come from inside the organization (machines or infrastructure used by another department in the organization and not released in time, materials that have been damaged because of unsuitable storage conditions, etc.) or from outside the organization (major supplier that has gone bankrupt or bad weather that has damaged resources). The project manager should use methodical steps to deal with problem solving, which can include:

- ◆ **Identify the problem.** Specify the problem.
- ◆ **Define the problem.** Break it into smaller, manageable problems.
- ◆ **Investigate.** Collect data.
- ◆ **Analyze.** Find the root cause of the problem.
- ◆ **Solve.** Choose the suitable solution from a variety of available ones.
- ◆ **Check the solution.** Determine if the problem has been fixed.

9.6.2.3 INTERPERSONAL AND TEAM SKILLS

Interpersonal and team skills, sometimes known as “soft skills,” are personal competencies. The interpersonal and team skills used in this process include:

- ◆ **Negotiation.** Described in Section 12.2.2.5. The project manager may need to negotiate for additional physical resources, changes in physical resources, or costs associated with the resources.
- ◆ **Influencing.** Described in Section 9.5.2.1. Influencing can help the project manager solve problems and obtain the resources needed in a timely manner.

9.6.2.4 PROJECT MANAGEMENT INFORMATION SYSTEM (PMIS)

Described in Section 4.3.2.2. Project management information systems can include resource management or scheduling software that can be used to monitor the resource utilization which helps ensure that the right resources are working on the right activities at the right time and place.

9.6.3 CONTROL RESOURCES: OUTPUTS

9.6.3.1 WORK PERFORMANCE INFORMATION

Described in Section 4.5.1.3. Work performance information includes information on how the project work is progressing by comparing resource requirements and resource allocation to resource utilization across the project activities. This comparison can show gaps in resource availability that need to be addressed.

9.6.3.2 CHANGE REQUESTS

Described in Section 4.3.3.4. When change requests occur as a result of carrying out the Control Resources process or when recommended, corrective, or preventive actions impact any of the components of the project management plan or project documents, the project manager needs to submit a change request. Change requests are processed for review and disposition through the Perform Integrated Change Control process (Section 4.6).

9.6.3.3 PROJECT MANAGEMENT PLAN UPDATES

Any change to the project management plan goes through the organization's change control process via a change request. Components that may require a change request for the project management plan include but are not limited to:

- ◆ **Resource management plan.** Described in Section 9.1.3.1. The resource management plan is updated to reflect actual experience in managing project resources.
- ◆ **Schedule baseline.** Described in Section 6.5.3.1. Changes to the project schedule may be required to reflect the way project resources are being managed.
- ◆ **Cost baseline.** Described in Section 7.3.3.1. Changes to the project cost baseline may be required to reflect the way project resources are being managed.

9.6.3.4 PROJECT DOCUMENTS UPDATES

Project documents that may be updated as a result of performing this process include but are not limited to:

- ◆ **Assumption log.** Described in Section 4.1.3.2. The assumption log may be updated with new assumptions regarding equipment, materials, supplies, and other physical resources.
- ◆ **Issue log.** Described in Section 4.3.3.3. New issues raised as a result of this process are recorded in the issue log.
- ◆ **Lessons learned register.** Described in Section 4.4.3.1. The lessons learned register can be updated with techniques that were effective in managing resource logistics, scrap, utilization variances, and corrective actions that were used to respond to resource variances.
- ◆ **Physical resource assignments.** Described in Section 9.3.3.1. Physical resource assignments are dynamic and subject to change due to availability, the project, organization, environment, or other factors.
- ◆ **Resource breakdown structure.** Described in Section 9.2.3.3. Changes to the resource breakdown structure may be required to reflect the way project resources are being used.
- ◆ **Risk register.** Described in Section 11.2.3.1. The risk register is updated with any new risks associated with resource availability, utilization, or other physical resource risks.

10

PROJECT COMMUNICATIONS MANAGEMENT

Project Communications Management includes the processes necessary to ensure that the information needs of the project and its stakeholders are met through development of artifacts and implementation of activities designed to achieve effective information exchange. Project Communications Management consists of two parts. The first part is developing a strategy to ensure communication is effective for stakeholders. The second part is carrying out the activities necessary to implement the communication strategy.

The Project Communications Management processes are:

10.1 Plan Communications Management—The process of developing an appropriate approach and plan for project communication activities based on the information needs of each stakeholder or group, available organizational assets, and the needs of the project.

10.2 Manage Communications—The process of ensuring timely and appropriate collection, creation, distribution, storage, retrieval, management, monitoring, and the ultimate disposition of project information.

10.3 Monitor Communications—The process of ensuring the information needs of the project and its stakeholders are met.

Figure 10-1 provides an overview of the Project Communications Management processes. The Project Communications Management processes are presented as discrete processes with defined interfaces while, in practice, they overlap and interact in ways that cannot be completely detailed in the *PMBOK® Guide*.



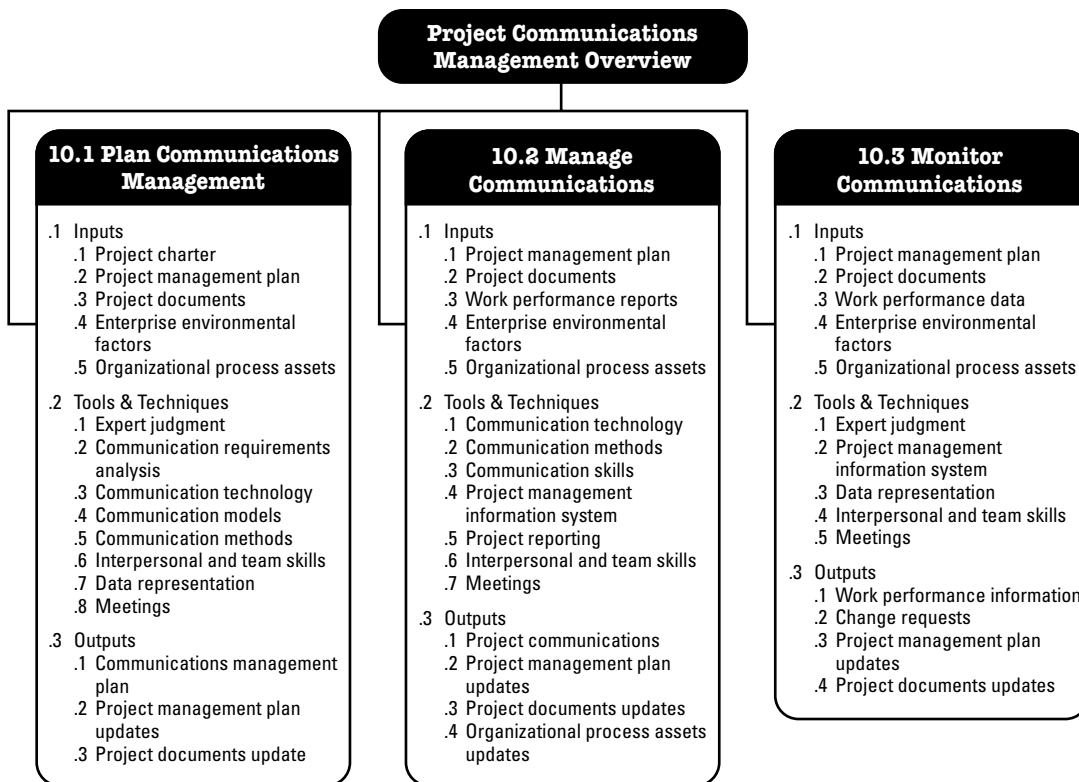

Figure 10-1. Project Communications Overview

KEY CONCEPTS FOR PROJECT COMMUNICATIONS MANAGEMENT

Communication is the exchange of information, intended or involuntary. The information exchanged can be in the form of ideas, instructions, or emotions. The mechanisms by which information is exchanged can be in:

- ◆ **Written form.** Either physical or electronic.
- ◆ **Spoken.** Either face-to-face or remote.
- ◆ **Formal or informal** (as in formal papers or social media).
- ◆ **Through gestures.** Tone of voice and facial expressions.
- ◆ **Through media.** Pictures, actions, or even just the choice of words.
- ◆ **Choice of words.** There is often more than one word to express an idea; there can be subtle differences in the meaning of each of these words and phrases.

Communications describe the possible means by which the information can be sent or received, either through communication activities, such as meetings and presentations, or artifacts, such as emails, social media, project reports, or project documentation.

Project managers spend most of their time communicating with team members and other project stakeholders, both internal (at all organizational levels) and external to the organization. Effective communication builds a bridge between diverse stakeholders who may have different cultural and organizational backgrounds as well as different levels of expertise, perspectives, and interests.

Communication activities have many dimensions, including but not limited to:

- ◆ **Internal.** Focus on stakeholders within the project and within the organization.
- ◆ **External.** Focus on external stakeholders such as customers, vendors, other projects, organizations, government, the public, and environmental advocates.
- ◆ **Formal.** Reports, formal meetings (both regular and ad hoc), meeting agendas and minutes, stakeholder briefings, and presentations.
- ◆ **Informal.** General communications activities using emails, social media, websites, and informal ad hoc discussions.
- ◆ **Hierarchical focus.** The position of the stakeholder or group with respect to the project team will affect the format and content of the message, in the following ways:
 - *Upward.* Senior management stakeholders.
 - *Downward.* The team and others who will contribute to the work of the project.
 - *Horizontal.* Peers of the project manager or team.
- ◆ **Official.** Annual reports; reports to regulators or government bodies.
- ◆ **Unofficial.** Communications that focus on establishing and maintaining the profile and recognition of the project and building strong relationships between the project team and its stakeholders using flexible and often informal means.
- ◆ **Written and oral.** Verbal (words and voice inflections) and nonverbal (body language and actions), social media and websites, media releases.

Communication develops the relationships necessary for successful project and program outcomes. Communication activities and artifacts to support communication vary widely, ranging from emails and informal conversations to formal meetings and regular project reports. The act of sending and receiving information takes place consciously or unconsciously through words, facial expressions, gestures and other actions. In the context of successfully managing project relationships with stakeholders, communication includes developing strategies and plans for suitable communications artifacts and activities with the stakeholder community and the application of skills to enhance the effectiveness of the planned and other ad hoc communications.

There are two parts to successful communication. The first part involves developing an appropriate communication strategy based on both the needs of the project and the project's stakeholders. From that strategy, a communications management plan is developed to ensure that the appropriate messages are communicated to stakeholders in various formats and various means as defined by the communication strategy. These messages constitute the project's communications—the second part of successful communication. Project communications are the products of the planning process, addressed by the communications management plan that defines the collection, creation, dissemination, storage, retrieval, management, tracking, and disposition of these communications artifacts. Finally, the communication strategy and communications management plan will form the foundation to monitor the effect of the communication.

The project's communications are supported by efforts to prevent misunderstandings and miscommunication and by careful selection of the methods, messengers, and messages developed from the planning process.

Misunderstandings can be reduced but not eliminated through using the 5Cs of written communications in composing a traditional (non-social media) written or spoken message:



- ◆ **Correct grammar and spelling.** Poor use of grammar or inaccurate spelling can be distracting and can also introduce distortions in the message, diminishing credibility.
- ◆ **Concise expression and elimination of excess words.** A concise, well-crafted message reduces the opportunities for misunderstanding the intent of the message.
- ◆ **Clear purpose and expression directed to the needs of the reader.** Ensure that the needs and interests of the audience are factored into the message.
- ◆ **Coherent logical flow of ideas.** A coherent logical flow of ideas and using “markers” such as introduction and summaries of the ideas throughout the writing.
- ◆ **Controlling flow of words and ideas.** Controlling the flow of words and ideas may involve graphics or just summaries.

The 5Cs of written communications are supported by communication skills, such as:

- ◆ **Listening actively.** Staying engaged with the speaker and summarizing conversations to ensure effective information exchange.
- ◆ **Awareness of cultural and personal differences.** Developing the team’s awareness of cultural and personal differences to reduce misunderstandings and enhance communication capability.
- ◆ **Identifying, setting, and managing stakeholder expectations.** Negotiating with stakeholders reduces the existence of conflicting expectations among the stakeholder community.
- ◆ **Enhancement of skills.** Enhancing the skills of all team members in the following activities:
 - Persuading a person, a team, or an organization to perform an action;
 - Motivating people and providing encouragement or reassurance;
 - Coaching to improve performance and achieve desired results;
 - Negotiating to achieve mutually acceptable agreements between parties and reduce approval or decision delays; and
 - Resolving conflict to prevent disruptive impacts.

The fundamental attributes of effective communication activities and developing effective communication artifacts are:

- Clarity on the purpose of the communication—defining its purpose;
- Understanding as much as possible about the receiver of the communications, meeting needs, and preferences; and
- Monitoring and measuring the effectiveness of the communications.

TRENDS AND EMERGING PRACTICES IN PROJECT COMMUNICATIONS MANAGEMENT

Along with a focus on stakeholders and recognition of the value to projects and organizations of effective stakeholder engagement comes the recognition that developing and implementing appropriate communication strategies is vital to maintaining effective relationships with stakeholders. Trends and emerging practices for Project Communications Management include but are not limited to:

- ◆ **Inclusion of stakeholders in project reviews.** The stakeholder community of each project includes individuals, groups, and organizations that the project team has identified as essential to the successful delivery of project objectives and organizational outcomes. An effective communication strategy requires regular and timely reviews of the stakeholder community and updates to manage changes in its membership and attitudes.
- ◆ **Inclusion of stakeholders in project meetings.** Project meetings should include stakeholders from outside the project and even the organization, where appropriate. Practices inherent in the agile approaches can be applied to all types of projects. Practices often include short, daily standup meetings, where the achievements and issues of the previous day, and plans for the current day's work, are discussed with the project team and key stakeholders.
- ◆ **Increased use of social computing.** Social computing in the form of infrastructure, social media services, and personal devices has changed how organizations and their people communicate and do business. Social computing incorporates different approaches to collaboration supported by public IT infrastructure. Social networking refers to how users build networks of relationships to explore their interests and activities with others. Social media tools can not only support information exchange, but also build relationships accompanied by deeper levels of trust and community.
- ◆ **Multifaceted approaches to communication.** The standard communication strategy for project stakeholder communications embraces and selects from all technologies and respects cultural, practical, and personal preferences for language, media, content, and delivery. When appropriate, social media and other advanced computing technologies may be included. Multifaceted approaches such as these are more effective for communicating to stakeholders from different generations and cultures.

TAILORING CONSIDERATIONS

Because each project is unique, the project team will need to tailor the way that Project Communications Management processes are applied. Considerations for tailoring include but are not limited to:

- ◆ **Stakeholders.** Are the stakeholders internal or external to the organization, or both?
- ◆ **Physical location.** What is the physical location of team members? Is the team colocated? Is the team in the same geographical area? Is the team distributed across multiple time zones?
- ◆ **Communications technology.** What technology is available to develop, record, transmit, retrieve, track, and store communication artifacts? What technologies are most appropriate and cost effective for communicating to stakeholders?
- ◆ **Language.** Language is a main factor to consider in communication activities. Is one language used? Or are many languages used? Have allowances been made to adjust to the complexity of team members from diverse language groups?
- ◆ **Knowledge management.** Does the organization have a formal knowledge management repository? Is the repository used?

CONSIDERATIONS FOR AGILE/ADAPTIVE ENVIRONMENTS

Project environments subject to various elements of ambiguity and change have an inherent need to communicate evolving and emerging details more frequently and quickly. This motivates streamlining team member access to information, frequent team checkpoints, and colocating team members as much as possible.

In addition, posting project artifacts in a transparent fashion, and holding regular stakeholder reviews are intended to promote communication with management and stakeholders.



10.1 PLAN COMMUNICATIONS MANAGEMENT

Plan Communications Management is the process of developing an appropriate approach and plan for project communications activities based on the information needs of each stakeholder or group, available organizational assets, and the needs of the project. The key benefit of this process is a documented approach to effectively and efficiently engage stakeholders by presenting relevant information in a timely manner. This process is performed periodically throughout the project as needed. The inputs, tools and techniques, and outputs of the process are depicted in Figure 10-2. Figure 10-3 depicts the data flow diagram for the process.

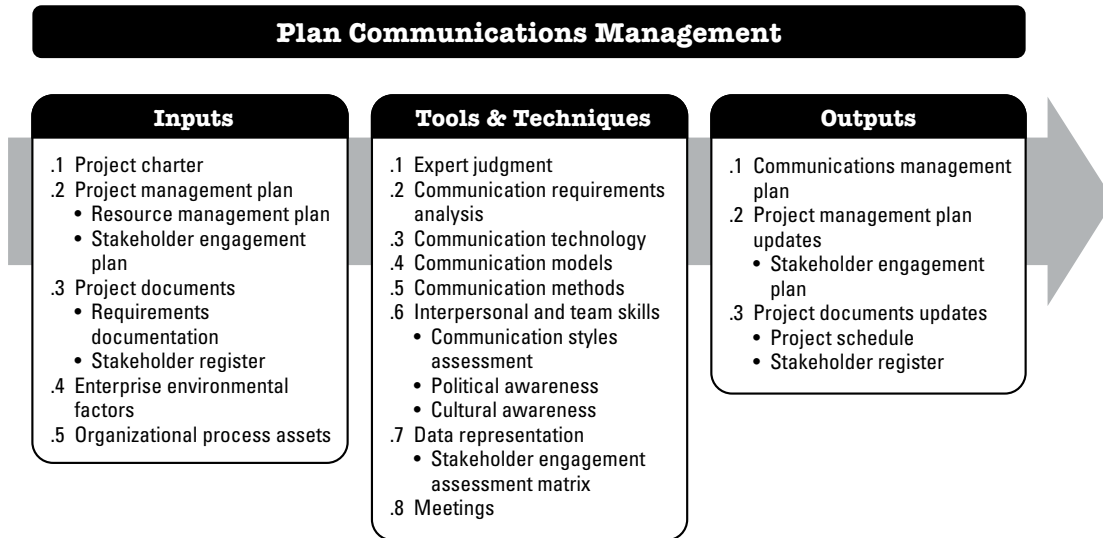

Figure 10-2. Plan Communications Management: Inputs, Tools & Techniques, and Outputs

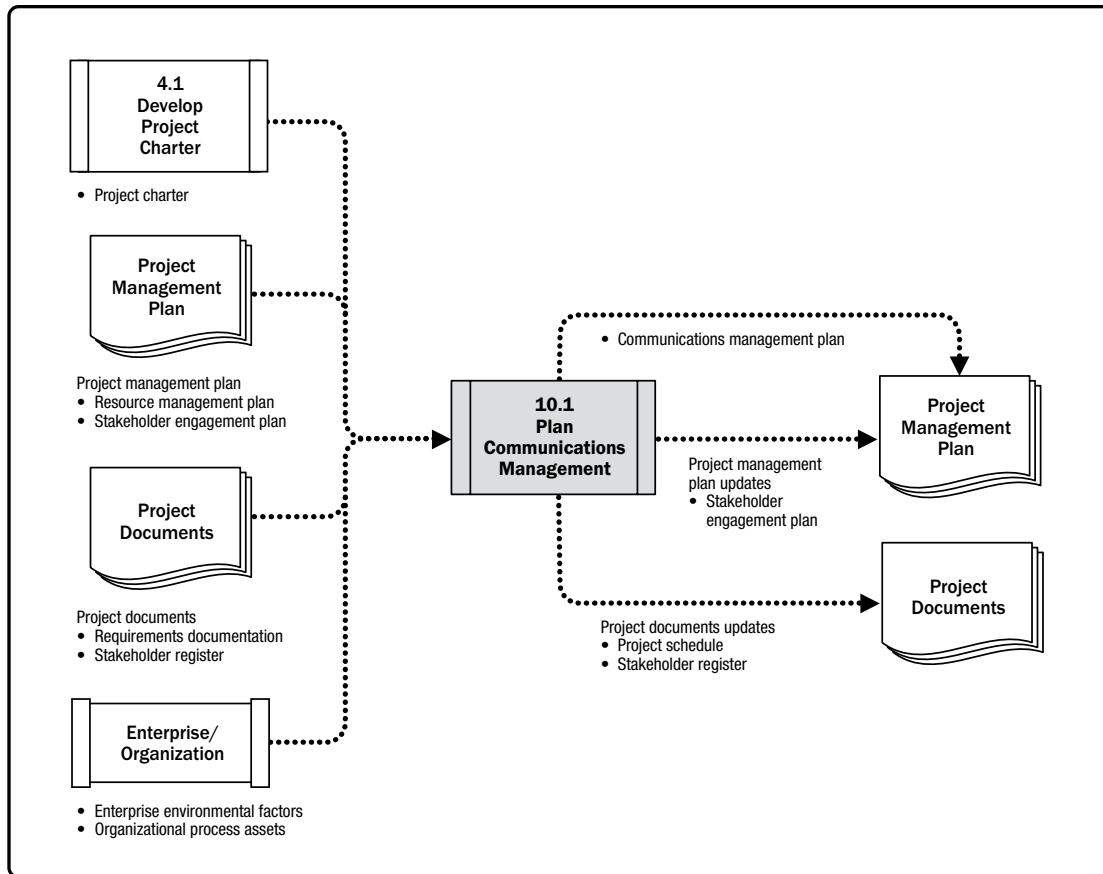

Figure 10-3. Plan Communications Management: Data Flow Diagram

An effective communications management plan that recognizes the diverse information needs of the project's stakeholders is developed early in the project life cycle. It should be reviewed regularly and modified when necessary, when the stakeholder community changes or at the start of each new project phase.

On most projects, communications planning is performed very early, during stakeholder identification and project management plan development.

While all projects share the need to communicate project information, the information needs and methods of distribution may vary widely. In addition, the methods of storage, retrieval, and ultimate disposition of the project information need to be considered and documented during this process. The results of the Plan Communications Management process should be reviewed regularly throughout the project and revised as needed to ensure continued applicability.

10.1.1 PLAN COMMUNICATIONS MANAGEMENT: INPUTS

10.1.1.1 PROJECT CHARTER

Described in Section 4.1.3.1. The project charter identifies the key stakeholder list. It may also contain information about the roles and responsibilities of the stakeholders.

10.1.1.2 PROJECT MANAGEMENT PLAN

Described in Section 4.2.3.1. Project management plan components include but are not limited to:

- ◆ **Resource management plan.** Described in Section 9.1.3.1. Provides guidance on how team resources will be categorized, allocated, managed, and released. Team members and groups may have communication requirements that should be identified in the communications management plan.
- ◆ **Stakeholder engagement plan.** Described in Section 13.2.3.1. The stakeholder engagement plan identifies the management strategies required to effectively engage stakeholders. These strategies are often fulfilled via communications.

10.1.1.3 PROJECT DOCUMENTS

Project documents that can be considered as inputs for this process include but are not limited to:

- ◆ **Requirements documentation.** Described in Section 5.2.3.1. Requirements documentation can include project stakeholder communications.
- ◆ **Stakeholder register.** Described in Section 13.1.3.1. The stakeholder register is used to plan communications activities with stakeholders.

10.1.1.4 ENTERPRISE ENVIRONMENTAL FACTORS

The enterprise environmental factors that can influence the Plan Communications Management process include but are not limited to:

- ◆ Organizational culture, political climate, and governance framework;
- ◆ Personnel administration policies;
- ◆ Stakeholder risk thresholds;
- ◆ Established communication channels, tools, and systems;
- ◆ Global, regional, or local trends, practices, or habits; and
- ◆ Geographic distribution of facilities and resources.

10.1.1.5 ORGANIZATIONAL PROCESS ASSETS

The organizational process assets that can influence the Plan Communications Management process include but are not limited to:

- ◆ Organizational policies and procedures for social media, ethics, and security;
- ◆ Organizational policies and procedures for issue, risk, change, and data management;
- ◆ Organizational communication requirements;
- ◆ Standardized guidelines for development, exchange, storage, and retrieval of information;
- ◆ Historical information and lessons learned repository; and
- ◆ Stakeholder and communications data and information from previous projects.

10.1.2 PLAN COMMUNICATIONS MANAGEMENT: TOOLS AND TECHNIQUES

10.1.2.1 EXPERT JUDGMENT

Described in Section 4.1.2.1. Expertise should be considered from individuals or groups with specialized knowledge or training in the following topics:

- ◆ Politics and power structures in the organization;
- ◆ Environment and culture of the organization and other customer organizations;
- ◆ Organizational change management approach and practices;
- ◆ Industry or type of project deliverables;
- ◆ Organizational communications technologies;
- ◆ Organizational policies and procedures regarding legal requirements of corporate communications;
- ◆ Organizational policies and procedures regarding security; and
- ◆ Stakeholders, including customers or sponsors.

10.1.2.2 COMMUNICATION REQUIREMENTS ANALYSIS

Analysis of communication requirements determines the information needs of the project stakeholders. These requirements are defined by combining the type and format of information needed with an analysis of the value of that information.

Sources of information typically used to identify and define project communication requirements include but are not limited to:

- ◆ Stakeholder information and communication requirements from within the stakeholder register and stakeholder engagement plan;
- ◆ Number of potential communication channels or paths, including one-to-one, one-to-many, and many-to-many communications;
- ◆ Organizational charts;
- ◆ Project organization and stakeholder responsibility, relationships, and interdependencies;
- ◆ Development approach;
- ◆ Disciplines, departments, and specialties involved in the project;
- ◆ Logistics of how many persons will be involved with the project and at which locations;
- ◆ Internal information needs (e.g., when communicating within organizations);
- ◆ External information needs (e.g., when communicating with the media, public, or contractors); and
- ◆ Legal requirements.

10.1.2.3 COMMUNICATION TECHNOLOGY

The methods used to transfer information among project stakeholders may vary significantly. Common methods used for information exchange and collaboration include conversations, meetings, written documents, databases, social media, and websites.

Factors that can affect the choice of communication technology include:

- ◆ **Urgency of the need for information.** The urgency, frequency, and format of the information to be communicated may vary from project to project and also within different phases of a project.
- ◆ **Availability and reliability of technology.** The technology that is required for distribution of project communications artifacts should be compatible, available, and accessible for all stakeholders throughout the project.
- ◆ **Ease of use.** The choice of communication technologies should be suitable for project participants and proper training events should be planned, where appropriate.

- ◆ **Project environment.** Whether the team will meet and operate on a face-to-face basis or in a virtual environment; whether they will be located in one or multiple time zones; whether they will use multiple languages for communication; and finally, whether there are any other project environmental factors, such as various aspects of culture, which may constrain the efficiency of the communication.
- ◆ **Sensitivity and confidentiality of the information.** Some aspects to consider are:
 - Whether information to be communicated is sensitive or confidential. If so, additional security measures may be required.
 - Social media policies for employees to ensure appropriate behavior, security, and the protection of proprietary information.

10.1.2.4 COMMUNICATION MODELS

Communication models can represent the communication process in its most basic linear form (sender and receiver), in a more interactive form that encompasses the additional element of feedback (sender, receiver, and feedback), or in a more complex model that incorporates the human elements of the sender(s) or receiver(s) and attempts to show the complexity of any communication that involves people.

- ◆ **Sample basic sender/receiver communication model.** This model describes communication as a process and consists of two parties, defined as the sender and receiver. This model is concerned with ensuring that the message is delivered, rather than understood. The sequence of steps in a basic communication model is:
 - *Encode.* The message is coded into symbols, such as text, sound or some other medium for transmission (sending).
 - *Transmit message.* The message is sent via a communication channel. The transmission of this message may be compromised by various physical factors such as unfamiliar technology or inadequate infrastructure. Noise and other factors may be present and contribute to loss of information in transmission and/or reception of the message.
 - *Decode.* The data received is translated by the receiver back into a form useful to the receiver.



- ◆ **Sample interactive communication model.** This model also describes communication as a process consisting of two parties, the sender and receiver, but recognizes the need to ensure that the message has been understood. In this model, noise includes any interference or barriers that might compromise the understanding of the message, such as the distraction of the receiver, variations in the perceptions of receivers, or lack of appropriate knowledge or interest. The additional steps in an interactive communication model are:
 - *Acknowledge.* Upon receipt of a message, the receiver may signal (acknowledge) receipt of the message, but this does not necessarily mean agreement with or comprehension of the message—merely that it has been received.
 - *Feedback/response.* When the received message has been decoded and understood, the receiver encodes thoughts and ideas into a message and then transmits this message to the original sender. If the sender perceives that the feedback matches the original message, the communication has been successful. In communication between people, feedback can be achieved through active listening, described in Section 10.2.2.6.

As part of the communication process, the sender is responsible for the transmission of the message, ensuring the information being communicated is clear and complete, and confirming the message is correctly interpreted. The receiver is responsible for ensuring that the information is received in its entirety, interpreted correctly, and acknowledged or responded to appropriately. These components take place in an environment where there will likely be noise and other barriers to effective communication.

Cross-cultural communication presents challenges to ensuring that the meaning of the message has been understood. Differences in communication styles can arise from differences in working methods, age, nationality, professional discipline, ethnicity, race, or gender. People from different cultures communicate using different languages (e.g., technical design documents, different styles) and expect different processes and protocols.

The communication model shown in Figure 10-4 incorporates the idea that the message itself and how it is transmitted are influenced by the sender's current emotional state, knowledge, background, personality, culture, and biases. Similarly, the receiver's emotional state knowledge, background, personality, culture, and biases will influence how the message is received and interpreted, and will contribute to the barriers or noise.

This communication model and its enhancements can assist in developing communication strategies and plans for person-to-person or even small group to small group communications. It is not useful for other communications artifacts such as emails, broadcast messages, or social media.

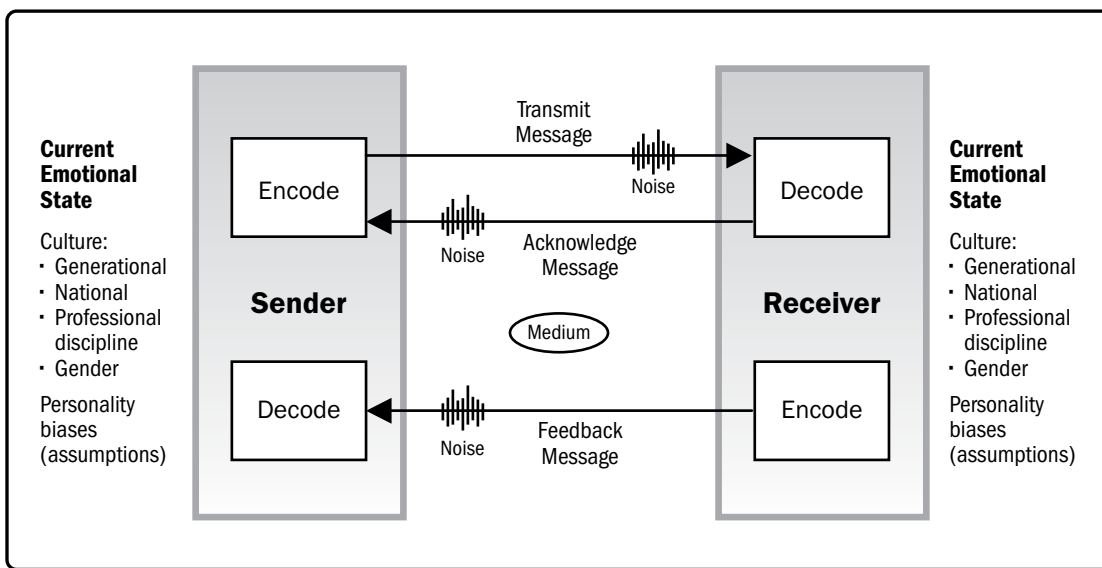

Figure 10-4. Communication Model for Cross-Cultural Communication



10.1.2.5 COMMUNICATION METHODS

There are several communication methods that are used to share information among project stakeholders. These methods are broadly classified as follows:

- ◆ **Interactive communication.** Between two or more parties performing a multidirectional exchange of information in real time. It employs communications artifacts such as meetings, phone calls, instant messaging, some forms of social media, and videoconferencing.
- ◆ **Push communication.** Sent or distributed directly to specific recipients who need to receive the information. This ensures that the information is distributed but does not ensure that it actually reached or was understood by the intended audience. Push communications artifacts include letters, memos, reports, emails, faxes, voice mails, blogs, and press releases.
- ◆ **Pull communication.** Used for large complex information sets, or for large audiences, and requires the recipients to access content at their own discretion subject to security procedures. These methods include web portals, intranet sites, e-learning, lessons learned databases, or knowledge repositories.

Different approaches should be applied to meet the needs of the major forms of communication defined in the communications management plan:

- ◆ **Interpersonal communication.** Information is exchanged between individuals, typically face-to-face.
- ◆ **Small group communication.** Occurs within groups of around three to six people.
- ◆ **Public communication.** A single speaker addressing a group of people.
- ◆ **Mass communication.** There is a minimal connection between the person or group sending the message and the large, sometimes anonymous groups for whom the information is intended.
- ◆ **Networks and social computing communication.** Supports emerging communication trends of many-to-many supported by social computing technology and media.

Possible communications artifacts and methods include but are not limited to:

- ◆ Notice boards,
- ◆ Newsletters/in-house magazines/e-magazines,
- ◆ Letters to staff/volunteers,
- ◆ Press releases,
- ◆ Annual reports,
- ◆ Emails and intranets,
- ◆ Web portals and other information repositories (for pull communication)
- ◆ Phone conversations,
- ◆ Presentations,
- ◆ Team briefings/group meetings,
- ◆ Focus groups,
- ◆ Face-to-face formal or informal meetings between various stakeholders,
- ◆ Consultation groups or staff forums, and
- ◆ Social computing technology and media.

10.1.2.6 INTERPERSONAL AND TEAM SKILLS

Interpersonal and team skills that can be used for this process include but are not limited to:

- ◆ **Communication styles assessment.** A technique used to assess communication styles and identify the preferred communication method, format, and content for planned communication activities. Often used with unsupportive stakeholders, this assessment may follow a stakeholder engagement assessment (described in Section 13.2.2.5) to identify gaps in stakeholder engagement that require additional tailored communication activities and artifacts.



- ◆ **Political awareness.** Political awareness helps the project manager to plan communications based on the project environment as well as the organization's political environment. Political awareness concerns the recognition of power relationships, both formal and informal, and also the willingness to operate within these structures. An understanding of the strategies of the organization, knowing who wields power and influence in this arena, and developing an ability to communicate with these stakeholders are all aspects of political awareness.
- ◆ **Cultural awareness.** Cultural awareness is an understanding of the differences between individuals, groups, and organizations and adapting the project's communication strategy in the context of these differences. This awareness and any consequent actions minimize misunderstandings and miscommunication that may result from cultural differences within the project's stakeholder community. Cultural awareness and cultural sensitivity help the project manager to plan communications based on the cultural differences and requirements of stakeholders and team members.

10.1.2.7 DATA REPRESENTATION

A data representation technique that can be used for this process includes but is not limited to a stakeholder engagement assessment matrix. Described in Section 13.2.2.5. The stakeholder engagement assessment matrix, shown in Figure 13-6, displays gaps between current and desired engagement levels of individual stakeholders, it can be further analyzed in this process to identify additional communication requirements (beyond the regular reports) as a method to close any engagement level gaps.

10.1.2.8 MEETINGS

Project meetings can include virtual (e-meetings) or face-to-face meetings, and can be supported with document collaboration technologies, including email messages and project websites. The Plan Communications Management process requires discussion with the project team to determine the most appropriate way to update and communicate project information, and to respond to requests from various stakeholders for information.

10.1.3 PLAN COMMUNICATIONS MANAGEMENT: OUTPUTS

10.1.3.1 COMMUNICATIONS MANAGEMENT PLAN

The communications management plan is a component of the project management plan that describes how project communications will be planned, structured, implemented, and monitored for effectiveness. The plan contains the following information:

- ◆ Stakeholder communication requirements;
- ◆ Information to be communicated, including language, format, content, and level of detail;
- ◆ Escalation processes;
- ◆ Reason for the distribution of that information;
- ◆ Timeframe and frequency for the distribution of required information and receipt of acknowledgment or response, if applicable;
- ◆ Person responsible for communicating the information;
- ◆ Person responsible for authorizing release of confidential information;
- ◆ Person or groups who will receive the information, including information about their needs, requirements, and expectations;
- ◆ Methods or technologies used to convey the information, such as memos, email, press releases, or social media;
- ◆ Resources allocated for communication activities, including time and budget;
- ◆ Method for updating and refining the communications management plan as the project progresses and develops, such as when the stakeholder community changes as the project moves through different phases;
- ◆ Glossary of common terminology;
- ◆ Flow charts of the information flow in the project, workflows with possible sequence of authorization, list of reports, meeting plans, etc.; and
- ◆ Constraints derived from specific legislation or regulation, technology, organizational policies, etc.

The communications management plan can include guidelines and templates for project status meetings, project team meetings, e-meetings, and email messages. The use of a project website and project management software can be included if these are to be used in the project.

10.1.3.2 PROJECT MANAGEMENT PLAN UPDATES

Any change to the project management plan goes through the organization's change control process via a change request. Components that may require a change request for the project management plan include but are not limited to the stakeholder engagement plan, which is described in Section 13.2.3.1. The stakeholder engagement plan is updated to reflect any processes, procedures, tools, or techniques that affect the engagement of stakeholders in project decisions and execution.

10.1.3.3 PROJECT DOCUMENTS UPDATES

Project documents that may be updated as a result of carrying out this process include but are not limited to:

- ◆ **Project schedule.** Described in Section 6.5.3.2. The project schedule may be updated to reflect communication activities.
- ◆ **Stakeholder register.** Described in Section 13.1.3.1. The stakeholder register may be updated to reflect communications planned.

10.2 MANAGE COMMUNICATIONS

Manage Communications is the process of ensuring timely and appropriate collection, creation, distribution, storage, retrieval, management, monitoring, and the ultimate disposition of project information. The key benefit of this process is that it enables an efficient and effective information flow between the project team and the stakeholders. This process is performed throughout the project.

The Manage Communications process identifies all aspects of effective communication, including choice of appropriate technologies, methods, and techniques. In addition, it should allow for flexibility in the communications activities, allowing adjustments in the methods and techniques to accommodate the changing needs of stakeholders and the project. The inputs, tools, techniques, and outputs of this process are depicted in Figure 10-5. Figure 10-6 depicts the data flow diagram of the Manage Communications process.

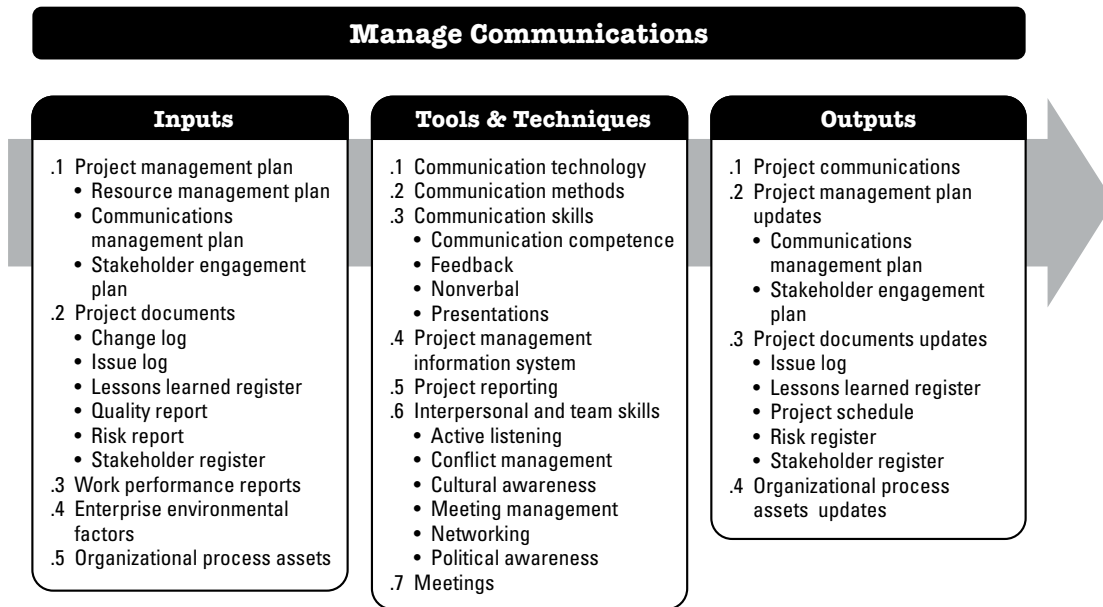

Figure 10-5. Manage Communications: Inputs, Tools & Techniques, and Outputs

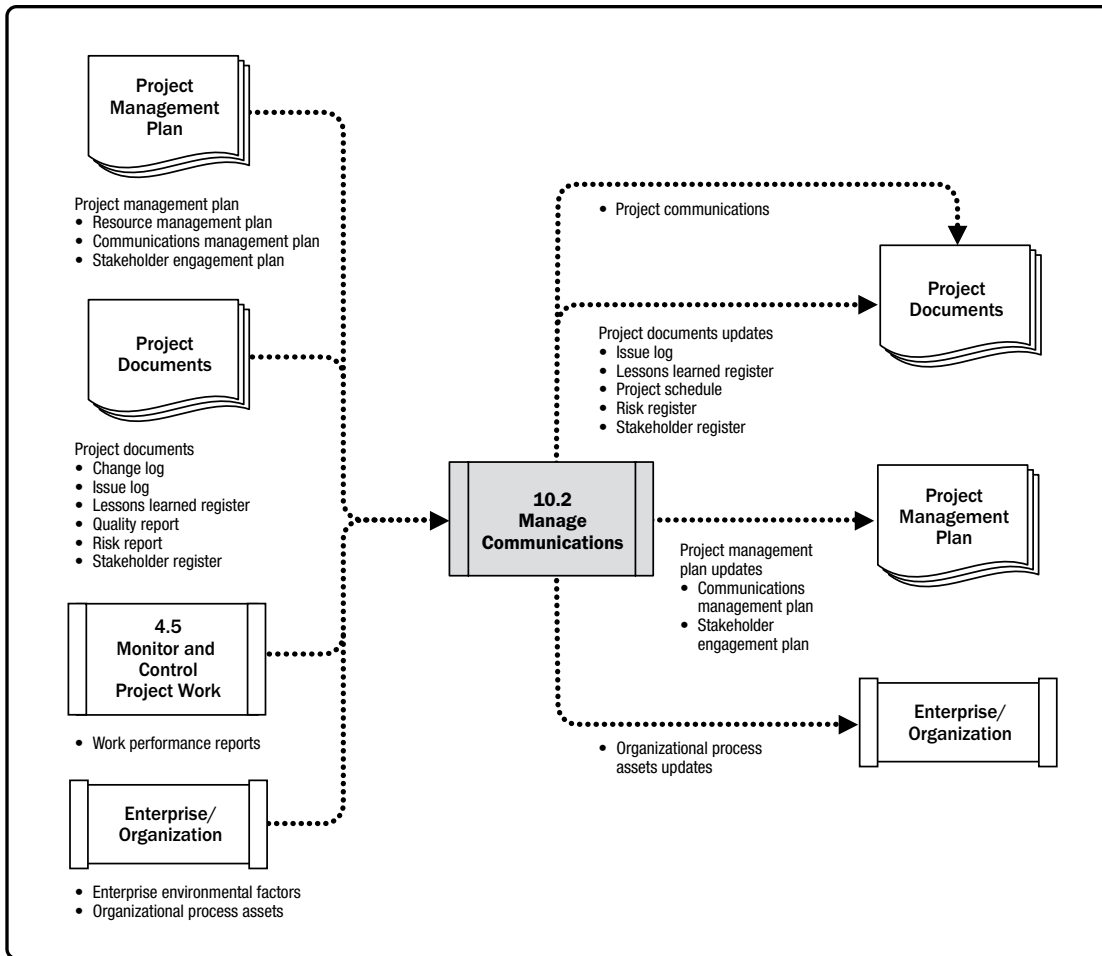

Figure 10-6. Manage Communications: Data Flow Diagram

This process goes beyond the distribution of relevant information and seeks to ensure that the information being communicated to project stakeholders has been appropriately generated and formatted, and received by the intended audience. It also provides opportunities for stakeholders to make requests for further information, clarification, and discussion. Techniques and considerations for effective communications management include but are not limited to:

- ◆ **Sender-receiver models.** Incorporating feedback loops to provide opportunities for interaction/participation and remove barriers to effective communication.
- ◆ **Choice of media.** Decisions about application of communications artifacts to meet specific project needs, such as when to communicate in writing versus orally, when to prepare an informal memo versus a formal report, and when to use push/pull options and the choice of appropriate technology.
- ◆ **Writing style.** Appropriate use of active versus passive voice, sentence structure, and word choice.
- ◆ **Meeting management.** Described in Section 10.2.2.6. Preparing an agenda, inviting essential participants, and ensuring they attend. Dealing with conflicts within the meeting or resulting from inadequate follow-up of minutes and actions, or attendance of the wrong people.
- ◆ **Presentations.** Awareness of the impact of body language and design of visual aids.
- ◆ **Facilitation.** Described in Section 4.1.2.3. Building consensus and overcoming obstacles such as difficult group dynamics, and maintaining interest and enthusiasm among group members.
- ◆ **Active listening.** Described in Section 10.2.2.6. Listening actively involves acknowledging, clarifying and confirming, understanding, and removing barriers that adversely affect comprehension.

10.2.1 MANAGE COMMUNICATIONS: INPUTS

10.2.1.1 PROJECT MANAGEMENT PLAN

Described in Section 4.2.3.1. Project management plan components include but are not limited to:

- ◆ **Resource management plan.** Described in Section 9.1.3.1. The resource management plan describes the communications that are needed for management of team or physical resources.
- ◆ **Communications management plan.** Described in Section 10.1.3.1. The communications management plan describes how project communications will be planned, structured, monitored, and controlled.
- ◆ **Stakeholder engagement plan.** Described in detail in Section 13.2.3.1. The stakeholder engagement plan describes how stakeholders will be engaged through appropriate communication strategies.

10.2.1.2 PROJECT DOCUMENTS

Project documents that can be considered as inputs for this process include but are not limited to

- ◆ **Change log.** Described in Section 4.6.3.3. The change log is used to communicate changes and approved, deferred, and rejected change requests to the impacted stakeholders.
- ◆ **Issue log.** Described in Section 4.6.3.3. Information about issues is communicated to impacted stakeholders.
- ◆ **Lessons learned register.** Described in Section 4.4.3.1. Lessons learned earlier in the project with regard to managing communications can be applied to later phases in the project to improve the efficiency and effectiveness of communications and the communication process.
- ◆ **Quality report.** Described in Section 8.2.3.1. Information in the quality report includes quality issues, project and product improvements, and process improvements. This information is forwarded to those who can take corrective actions in order to achieve the project quality expectations.
- ◆ **Risk report.** Described in Section 11.2.3.2. The risk report presents information on sources of overall project risk, together with summary information on identified individual project risks. This information is communicated to risk owners and other impacted stakeholders.
- ◆ **Stakeholder register.** Described in Section 13.1.3.1. The stakeholder register identifies the individuals, groups, or organizations that will need various types of information.

10.2.1.3 WORK PERFORMANCE REPORTS

Described in Section 4.5.3.1. Work performance reports are circulated to the project stakeholders through this process as defined in the communications management plan. Examples of work performance reports include status reports and progress reports. Work performance reports can contain earned value graphs and information, trend lines and forecasts, reserve burndown charts, defect histograms, contract performance information, and risk summaries. They can be presented as dashboards, heat reports, stop light charts, or other representations useful for creating awareness and generating decisions and actions.

10.2.1.4 ENTERPRISE ENVIRONMENTAL FACTORS

The enterprise environmental factors that can influence this process include but are not limited to:

- ◆ Organizational culture, political climate, and governance framework;
- ◆ Personnel administration policies;
- ◆ Stakeholder risk thresholds;
- ◆ Established communication channels, tools, and systems;
- ◆ Global, regional, or local trends and practices or habits; and
- ◆ Geographic distribution of facilities and resources.

10.2.1.5 ORGANIZATIONAL PROCESS ASSETS

The organizational process assets that can influence this process include but are not limited to:

- ◆ Corporate policies and procedures for social media, ethics, and security;
- ◆ Corporate policies and procedures for issue, risk, change, and data management;
- ◆ Organizational communication requirements;
- ◆ Standardized guidelines for development, exchange, storage, and retrieval of information; and
- ◆ Historical information from previous projects, including the lessons learned repository.

10.2.2 MANAGE COMMUNICATIONS: TOOLS AND TECHNIQUES

10.2.2.1 COMMUNICATION TECHNOLOGY

Described in Section 10.1.2.3. Factors that influence the technology include whether the team is colocated, the confidentiality of any information that needs to be shared, resources available to the team members, and how the organization's culture influences the way in which meetings and discussions are normally conducted.

10.2.2.2 COMMUNICATION METHODS

Described in Section 10.1.2.5. The choice of communication methods should allow flexibility in the event that the membership of the stakeholder community changes or their needs and expectations change.

10.2.2.3 COMMUNICATION SKILLS

Communication techniques that can be used for this process include but are not limited to:

- ◆ **Communication competence.** A combination of tailored communication skills that considers factors such as clarity of purpose in key messages, effective relationships and information sharing, and leadership behaviors.
- ◆ **Feedback.** Feedback is information about reactions to communications, a deliverable, or a situation. Feedback supports interactive communication between the project manager, team and all other project stakeholders. Examples include coaching, mentoring, and negotiating.
- ◆ **Nonverbal.** Examples of nonverbal communication include appropriate body language to transmit meaning through gestures, tone of voice, and facial expressions. Mirroring and eye contact are also important techniques. The team members should be aware of how they are expressing themselves both through what they say and what they don't say.
- ◆ **Presentations.** A presentation is the formal delivery of information and/or documentation. Clear and effective presentations of project information to relevant stakeholders can include but are not limited to:
 - Progress reports and information updates to stakeholders;
 - Background information to support decision making;
 - General information about the project and its objectives, for the purposes of raising the profile of the work of the project and the team; and
 - Specific information aimed at increasing understanding and support of the work and objectives of the project.

Presentations will be successful when the content and delivery take the following into account:

- The audience, their expectations, and needs; and
- The needs and objectives of the project and project team.

10.2.2.4 PROJECT MANAGEMENT INFORMATION SYSTEM (PMIS)

Described in Section 4.3.2.2. Project management information systems can ensure that stakeholders can easily retrieve the information they need in a timely way. Project information is managed and distributed using a variety of tools, including:

- ◆ **Electronic project management tools.** Project management software, meeting and virtual office support software, web interfaces, specialized project portals and dashboards, and collaborative work management tools.
- ◆ **Electronic communications management.** Email, fax, and voice mail; audio, video and web conferencing; and websites and web publishing.
- ◆ **Social media management.** Websites and web publishing; and blogs and applications, which offer the opportunity to engage with stakeholders and form online communities.

10.2.2.5 PROJECT REPORTING

Project reporting is the act of collecting and distributing project information. Project information is distributed to many groups of stakeholders and should be adapted to provide information at an appropriate level, format, and detail for each type of stakeholder. The format may range from a simple communication to more elaborate custom reports and presentations. Information may be prepared regularly or on an exception basis. While work performance reports are the output of the Monitor and Control Project Work process, this process develops ad hoc reports, project presentations, blogs, and other types of communication about the project.

10.2.2.6 INTERPERSONAL AND TEAM SKILLS

Interpersonal and team skills that can be used for this process include but are not limited to:

- ◆ **Active listening.** Techniques of active listening involve acknowledging, clarifying and confirming, understanding, and removing barriers that adversely affect comprehension.
- ◆ **Conflict management.** Described in Section 9.5.2.1.
- ◆ **Cultural awareness.** Described in Section 10.1.2.6.
- ◆ **Meeting management.** Meeting management is taking steps to ensure meetings meet their intended objectives effectively and efficiently. The following steps should be used for meeting planning:
 - Prepare and distribute the agenda stating the objectives of the meeting.
 - Ensure that the meetings start and finish at the published time.
 - Ensure the appropriate participants are invited and attend.
 - Stay on topic.
 - Manage expectations, issues, and conflicts during the meeting.
 - Record all actions and those who have been allocated the responsibility for completing the action.
- ◆ **Networking.** Networking is interacting with others to exchange information and develop contacts. Networks provide project managers and their teams with access to informal organizations to solve problems, influence actions of their stakeholders, and increase stakeholder support for the work and outcomes of the project, thus improving performance.
- ◆ **Political awareness.** Described in Section 10.1.2.6. Political awareness assists the project manager in engaging stakeholders appropriately to maintain their support throughout the project.

10.2.2.7 MEETINGS

Meetings support the actions defined in the communication strategy and communications plan.

10.2.3 MANAGE COMMUNICATIONS: OUTPUTS

10.2.3.1 PROJECT COMMUNICATIONS

Project communications artifacts may include but are not limited to: performance reports, deliverable status, schedule progress, cost incurred, presentations, and other information required by stakeholders.

10.2.3.2 PROJECT MANAGEMENT PLAN UPDATES

Any change to the project management plan goes through the organization's change control process via a change request. Components of the project management plan that may be updated as a result of carrying out this process include but are not limited to:

- ◆ **Communications management plan.** Described in Section 10.1.3.1. When changes are made to the project communications approach as a result of this process, these changes are reflected in the project communications plan.
- ◆ **Stakeholder engagement plan.** Described in Section 13.2.3.1. Stakeholder communication requirements and agreed-upon communications strategies are updated as a result of this process.

10.2.3.3 PROJECT DOCUMENTS UPDATES

Project documents that may be updated as a result of carrying out this process include but are not limited to:

- ◆ **Issue log.** Described in Sections 4.3.3.3. The issue log is updated to reflect any communication issues on the project, or how any communications have been used to impact active issues.
- ◆ **Lessons learned register.** Described in Section 4.3.3.1. The lessons learned register is updated with information on challenges encountered and how they could have been avoided as well as approaches that worked well and what did not work well for managing communications.
- ◆ **Project schedule.** Described in Section 6.5.3.2. The project schedule may be updated to reflect the status of communication activities.
- ◆ **Risk register.** Described in Section 11.2.3.1. The risk register is updated to capture risks associated with managing communications.
- ◆ **Stakeholder register.** Described in Section 13.1.3.1. The stakeholder register can be updated to include information regarding communications activities with project stakeholders.

10.2.3.4 ORGANIZATIONAL PROCESS ASSETS UPDATES

Organizational process assets that may be updated as a result of this process include but are not limited to:

- ◆ Project records such as correspondence, memos, meeting minutes and other documents used on the project; and
- ◆ Planned and ad hoc project reports and presentations.

10.3 MONITOR COMMUNICATIONS

Monitor Communications is the process of ensuring the information needs of the project and its stakeholders are met. The key benefit of this process is the optimal information flow as defined in the communications management plan and the stakeholder engagement plan. This process is performed throughout the project. The inputs, tools and techniques, and outputs of the process are depicted in Figure 10-7. Figure 10-8 depicts the data flow diagram for the process.

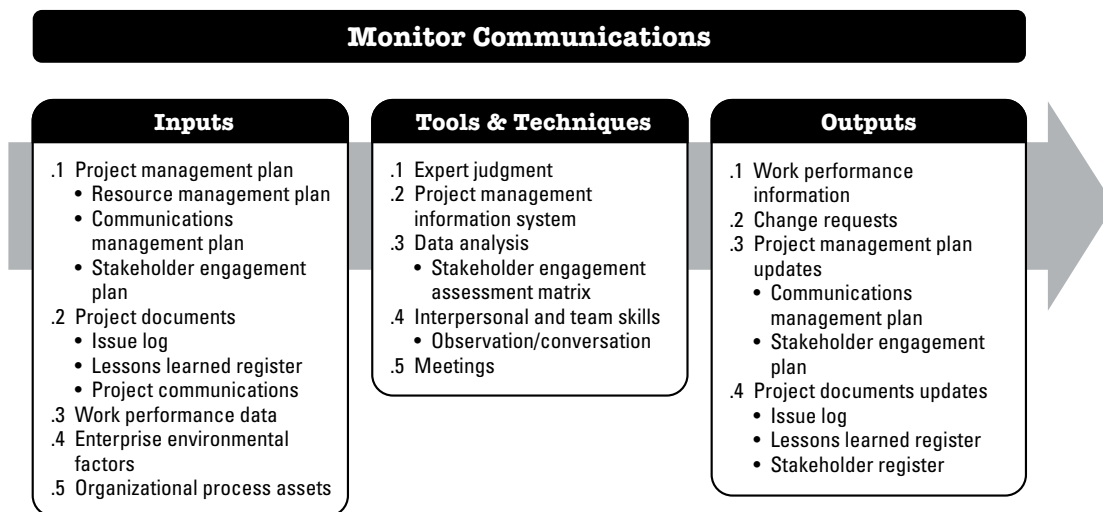

Figure 10-7. Monitor Communications: Inputs, Tools & Techniques, and Outputs

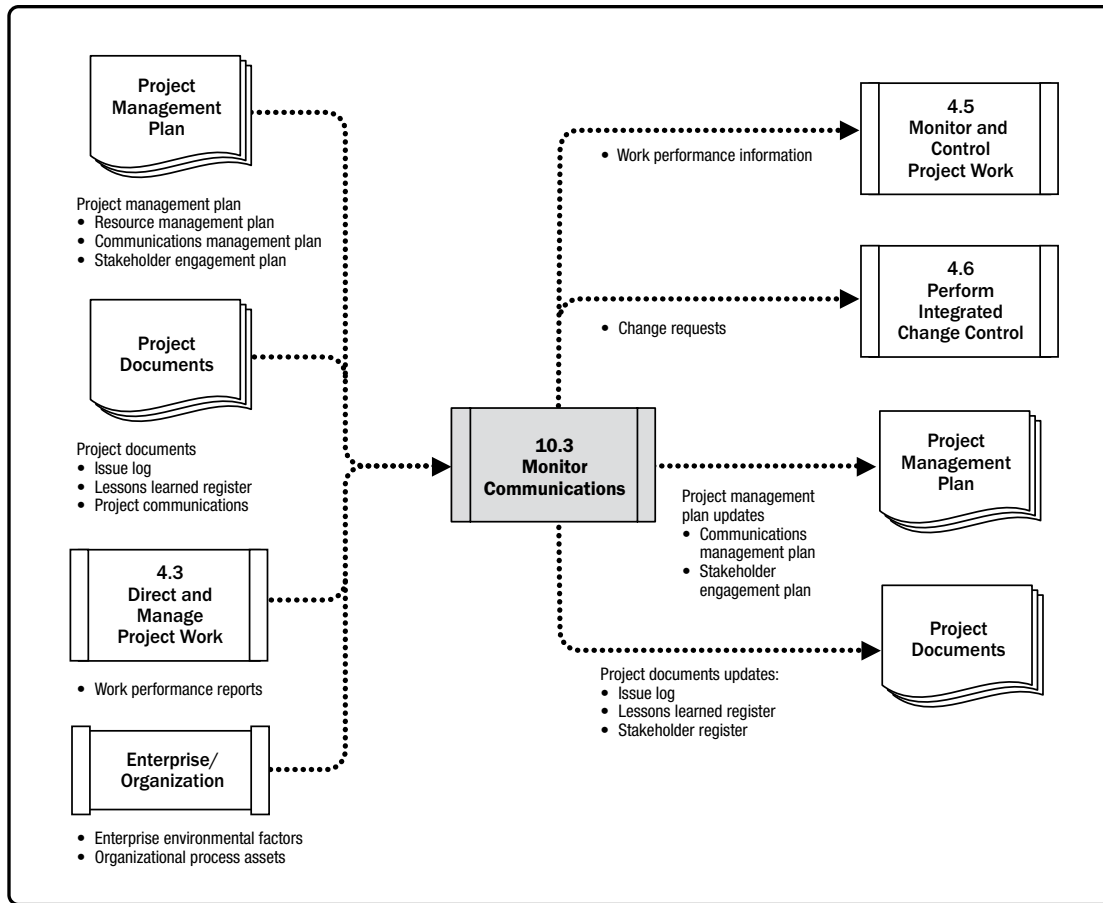

Figure 10-8. Monitor Communications: Data Flow Diagram

Monitor Communications determines if the planned communications artifacts and activities have had the desired effect of increasing or maintaining stakeholders’ support for the project’s deliverables and expected outcomes. The impact and consequences of project communications should be carefully evaluated and monitored to ensure that the right message with the right content (the same meaning for sender and receiver) is delivered to the right audience, through the right channel, and at the right time. Monitor Communications may require a variety of methods, such as customer satisfaction surveys, collecting lessons learned, observations of the team, reviewing data from the issue log, or evaluating changes in the stakeholder engagement assessment matrix described in Section 13.2.2.5.

The Monitor Communications process can trigger an iteration of the Plan Communications Management and/or Manage Communications processes to improve effectiveness of communication through additional and possibly amended communications plans and activities. Such iterations illustrate the continuous nature of the Project Communications Management processes. Issues or key performance indicators, risks, or conflicts may trigger an immediate revision.

10.3.1 MONITOR COMMUNICATIONS: INPUTS

10.3.1.1 PROJECT MANAGEMENT PLAN

Described in Section 4.2.3.1. Project management plan components include but are not limited to:

- ◆ **Resource management plan.** Described in Section 9.1.3.1. The resource management plan can be used to understand the actual project organization and any changes through understanding of roles and responsibilities and the project organization charts.
- ◆ **Communications management plan.** Described in Section 10.1.3.1. The communications management plan contains the current plan for collecting, creating, and distributing information in a timely manner. It identifies the team members, stakeholders, and the work involved in the communication process.
- ◆ **Stakeholder engagement plan.** Described in Section 13.2.3.1. The stakeholder engagement plan identifies the communication strategies that are planned to engage stakeholders.

10.3.1.2 PROJECT DOCUMENTS

Project documents that can be considered as inputs for this process include but are not limited to:

- ◆ **Issue log.** Described in Section 4.3.3.3. The issue log provides the project's history, a record of stakeholder engagement issues, and how they were resolved.
- ◆ **Lessons learned register.** Described in Section 4.4.3.1. Lessons learned earlier in the project can be applied to later phases in the project to improve communication effectiveness.
- ◆ **Project communications.** Described in Section 10.2.3.1. Provides information about communications that have been distributed.

10.3.1.3 WORK PERFORMANCE DATA

Described in Section 4.3.3.2. Work performance data contains data on the types and quantities of communications that have actually been distributed.

10.3.1.4 ENTERPRISE ENVIRONMENTAL FACTORS

The enterprise environmental factors that can influence the Monitor Communications process include but are not limited to:

- ◆ Organizational culture, political climate, and governance framework;
- ◆ Established communication channels, tools, and systems;
- ◆ Global, regional, or local trends, practices, or habits; and
- ◆ Geographic distribution of facilities and resources.

10.3.1.5 ORGANIZATIONAL PROCESS ASSETS

The organizational process assets that may influence the Monitor Communications process include but are not limited to:

- ◆ Corporate policies and procedures for social media, ethics, and security;
- ◆ Organizational communication requirements;
- ◆ Standardized guidelines for development, exchange, storage, and retrieval of information;
- ◆ Historical information and lessons learned repository from previous projects; and
- ◆ Stakeholder and communications data and information from previous projects.

10.3.2 MONITOR COMMUNICATIONS: TOOLS AND TECHNIQUES

10.3.2.1 EXPERT JUDGMENT

Described in Section 4.1.2.1. Expertise should be considered from individuals or groups with specialized knowledge or training in the following topics:

- ◆ Communications with the public, the community, and the media, and, in an international environment, between virtual groups; and
- ◆ Communications and project management systems.

10.3.2.2 PROJECT MANAGEMENT INFORMATION SYSTEM (PMIS)

Described in Section 4.3.2.2. Project management information systems provides a set of standard tools for the project manager to capture, store, and distribute information to internal and external stakeholders with the information they need according the communications plan. The information contained in the system is monitored to assess its validity and effectiveness.

10.3.2.3 DATA REPRESENTATION

A data representation technique that can be used includes but is not limited to the stakeholder engagement assessment matrix (Section 13.2.2.5), which can provide information about the effectiveness of the communications activities. This is achieved by reviewing changes between desired and current engagement and adjusting communications as necessary.

10.3.2.4 INTERPERSONAL AND TEAM SKILLS

Interpersonal and team skills that can be used for this process include but are not limited to observation/conversation as described in Section 5.2.2.6. Discussion and dialogue with the project team helps determine the most appropriate way to update and communicate project performance, and to respond to requests from stakeholders for information. Observation and conversation enables the project manager to identify issues within the team, conflicts between people, or individual performance issues.

10.3.2.5 MEETINGS

Face-to-face or virtual meetings are used for decision making; responding to stakeholder requests; and having discussions with suppliers, vendors, and other project stakeholders.

10.3.3 MONITOR COMMUNICATIONS: OUTPUTS

10.3.3.1 WORK PERFORMANCE INFORMATION

Described in Section 4.5.1.3. Work performance information includes information on how project communication is performing by comparing the communications that were implemented compared to those that were planned. It also considers feedback on communications, such as survey results on communication effectiveness.

10.3.3.2 CHANGE REQUESTS

Described in Section 4.3.3.4. The Monitor Communications process often results in the need for adjustment, action, and intervention on communications activities defined in the communications management plan. Change requests are processed through the Perform Integrated Change Control process (Section 4.6).

These change requests may result in:

- ◆ Revision of stakeholder communication requirements, including stakeholders' information distribution, content or format, and distribution method; and
- ◆ New procedures to eliminate bottlenecks.

10.3.3.3 PROJECT MANAGEMENT PLAN UPDATES

Any change to the project management plan goes through the organization's change control process via a change request. Components that may require a change request for the project management plan include but are not limited to:

- ◆ **Communications management plan.** Described in Section 10.1.3.1. The communications management plan is updated with new information to make communication more effective.
- ◆ **Stakeholder engagement plan.** Described in Section 13.2.3.1. The stakeholder engagement plan is updated to reflect the actual situation of stakeholders, their communication needs, and their importance.

10.3.3.4 PROJECT DOCUMENTS UPDATES

Project documents that may be updated as a result of carrying out this process include but are not limited to:

- ◆ **Issue log.** Described in Section 4.3.3.3. The issue log may be updated with new information on issues raised, their progress, and resolution.
- ◆ **Lessons learned register.** Described in Section 4.4.3.1. The lessons learned register may be updated with causes of issues, reasons behind the corrective actions chosen, and other communication lessons learned as appropriate.
- ◆ **Stakeholder register.** Described in Section 13.1.3.1. The stakeholder register may be updated with revised stakeholder communication requirements.



11

PROJECT RISK MANAGEMENT

Project Risk Management includes the processes of conducting risk management planning, identification, analysis, response planning, response implementation, and monitoring risk on a project. The objectives of project risk management are to increase the probability and/or impact of positive risks and to decrease the probability and/or impact of negative risks, in order to optimize the chances of project success.

The Project Risk Management processes are:

11.1 Plan Risk Management—The process of defining how to conduct risk management activities for a project.

11.2 Identify Risks—The process of identifying individual project risks as well as sources of overall project risk, and documenting their characteristics.

11.3 Perform Qualitative Risk Analysis—The process of prioritizing individual project risks for further analysis or action by assessing their probability of occurrence and impact as well as other characteristics.

11.4 Perform Quantitative Risk Analysis—The process of numerically analyzing the combined effect of identified individual project risks and other sources of uncertainty on overall project objectives.

11.5 Plan Risk Responses—The process of developing options, selecting strategies, and agreeing on actions to address overall project risk exposure, as well as to treat individual project risks.

11.6 Implement Risk Responses—The process of implementing agreed-upon risk response plans.

11.7 Monitor Risks—The process of monitoring the implementation of agreed-upon risk response plans, tracking identified risks, identifying and analyzing new risks, and evaluating risk process effectiveness throughout the project.

Figure 11-1 provides an overview of the Project Risk Management processes. The Project Management Risk processes are presented as discrete processes with defined interfaces while, in practice, they overlap and interact in ways that cannot be completely detailed in this *PMBOK® Guide*.

Project Risk Management Overview

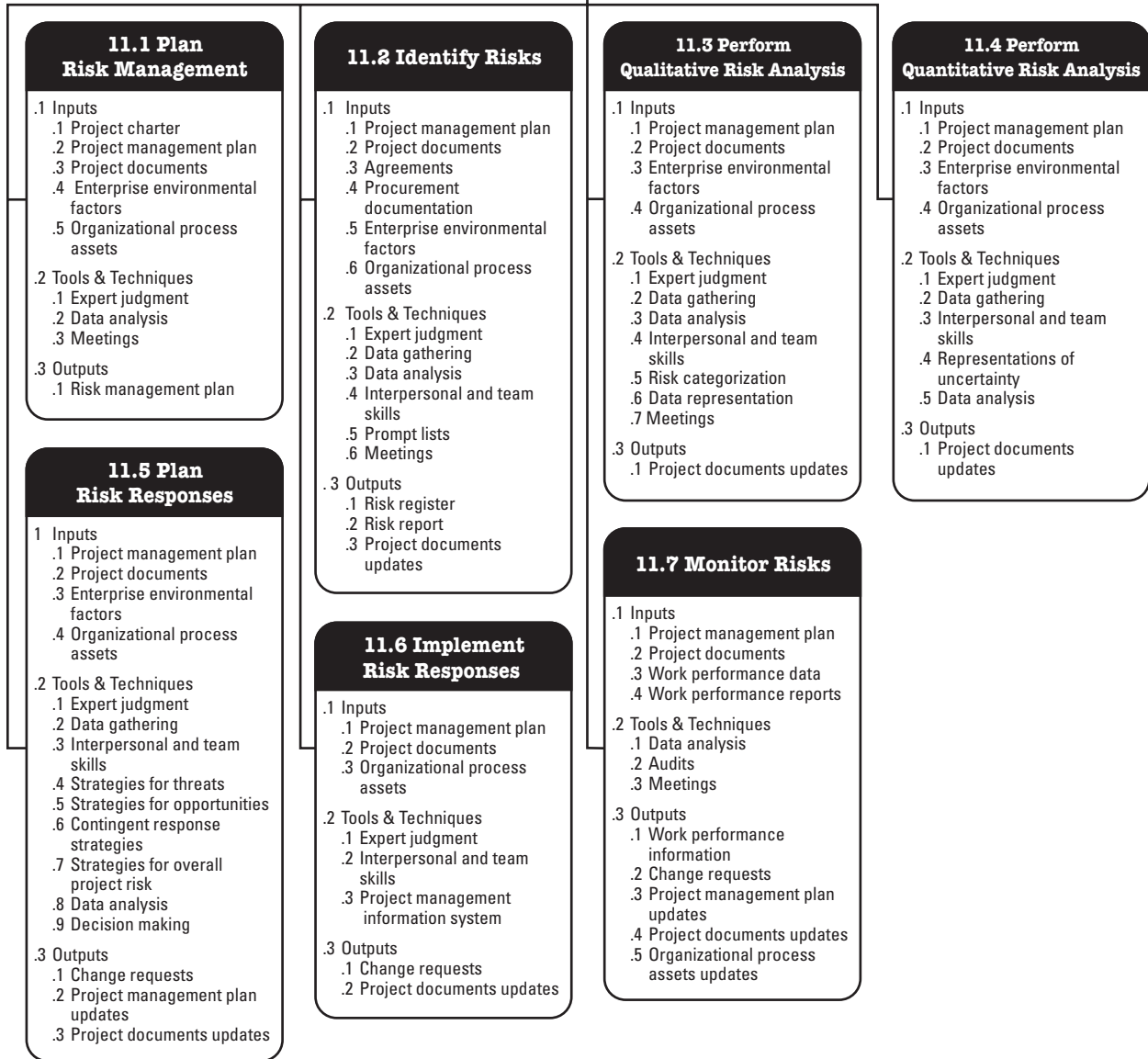

Figure 11-1. Project Risk Management Overview

KEY CONCEPTS FOR PROJECT RISK MANAGEMENT

All projects are risky since they are unique undertakings with varying degrees of complexity that aim to deliver benefits. They do this in a context of constraints and assumptions, while responding to stakeholder expectations that may be conflicting and changing. Organizations should choose to take project risk in a controlled and intentional manner in order to create value while balancing risk and reward.

Project Risk Management aims to identify and manage risks that are not addressed by the other project management processes. When unmanaged, these risks have the potential to cause the project to deviate from the plan and fail to achieve the defined project objectives. Consequently, the effectiveness of Project Risk Management is directly related to project success.

Risk exists at two levels within every project. Each project contains individual risks that can affect the achievement of project objectives. It is also important to consider the riskiness of the overall project, which arises from the combination of individual project risks and other sources of uncertainty. Project Risk Management processes address both levels of risk in projects, and these are defined as follows:

- ◆ **Individual project risk** is an uncertain event or condition that, if it occurs, has a positive or negative effect on one or more project objectives.
- ◆ **Overall project risk** is the effect of uncertainty on the project as a whole, arising from all sources of uncertainty including individual risks, representing the exposure of stakeholders to the implications of variations in project outcome, both positive and negative.

Individual project risks can have a positive or negative effect on project objectives if they occur. Project Risk Management aims to exploit or enhance positive risks (opportunities) while avoiding or mitigating negative risks (threats). Unmanaged threats may result in issues or problems such as delay, cost overruns, performance shortfall, or loss of reputation. Opportunities that are captured can lead to benefits such as reduced time and cost, improved performance, or reputation.

Overall project risk can also be positive or negative. Management of overall project risk aims to keep project risk exposure within an acceptable range by reducing drivers of negative variation, promoting drivers of positive variation, and maximizing the probability of achieving overall project objectives.



Risks will continue to emerge during the lifetime of the project, so Project Risk Management processes should be conducted iteratively. Risk is initially addressed during project planning by shaping the project strategy. Risk should also be monitored and managed as the project progresses to ensure that the project stays on track and emergent risks are addressed.

In order to manage risk effectively on a particular project, the project team needs to know what level of risk exposure is acceptable in pursuit of the project objectives. This is defined by measurable risk thresholds that reflect the risk appetite of the organization and project stakeholders. Risk thresholds express the degree of acceptable variation around a project objective. They are explicitly stated and communicated to the project team and reflected in the definitions of risk impact levels for the project.

TRENDS AND EMERGING PRACTICES IN PROJECT RISK MANAGEMENT

The focus of project risk management is broadening to ensure that all types of risk are considered, and that project risks are understood in a wider context. Trends and emerging practices for Project Risk Management include but are not limited to:

- ◆ **Non-event risks.** Most projects focus only on risks that are uncertain future events that may or may not occur. Examples of event-based risks include: a key seller may go out of business during the project, the customer may change the requirement after design is complete, or a subcontractor may propose enhancements to the standard operating processes.

There is an increasing recognition that non-event risks need to be identified and managed. There are two main types of non-event risks:

- **Variability risk.** Uncertainty exists about some key characteristics of a planned event or activity or decision. Examples of variability risks include: productivity may be above or below target, the number of errors found during testing may be higher or lower than expected, or unseasonal weather conditions may occur during the construction phase.
- **Ambiguity risk.** Uncertainty exists about what might happen in the future. Areas of the project where imperfect knowledge might affect the project's ability to achieve its objectives include: elements of the requirement or technical solution, future developments in regulatory frameworks, or inherent systemic complexity in the project.

Variability risks can be addressed using Monte Carlo analysis, with the range of variation reflected in probability distributions, followed by actions to reduce the spread of possible outcomes. Ambiguity risks are managed by defining those areas where there is a deficit of knowledge or understanding, then filling the gap by obtaining expert external input or benchmarking against best practices. Ambiguity is also addressed through incremental development, prototyping, or simulation.

- ◆ **Project resilience.** The existence of emergent risk is becoming clear, with a growing awareness of so-called unknowable-unknowns. These are risks that can only be recognized after they have occurred. Emergent risks can be tackled through developing project resilience. This requires each project to have:
 - Right level of budget and schedule contingency for emergent risks, in addition to a specific risk budget for known risks;
 - Flexible project processes that can cope with emergent risk while maintaining overall direction toward project goals, including strong change management;
 - Empowered project team that has clear objectives and that is trusted to get the job done within agreed-upon limits;
 - Frequent review of early warning signs to identify emergent risks as early as possible; and
 - Clear input from stakeholders to clarify areas where the project scope or strategy can be adjusted in response to emergent risks.

- ◆ **Integrated risk management.** Projects exist in an organizational context, and they may form part of a program or portfolio. Risk exists at each of these levels, and risks should be owned and managed at the appropriate level. Some risks identified at higher levels will be delegated to the project team for management, and some project risks may be escalated to higher levels if they are best managed outside the project. A coordinated approach to enterprise-wide risk management ensures alignment and coherence in the way risk is managed across all levels. This builds risk efficiency into the structure of programs and portfolios, providing the greatest overall value for a given level of risk exposure.

TAILORING CONSIDERATIONS

Because each project is unique, it is necessary to tailor the way Project Risk Management processes are applied. Considerations for tailoring include but are not limited to:

- ◆ **Project size.** Does the project's size in terms of budget, duration, scope, or team size require a more detailed approach to risk management? Or is it small enough to justify a simplified risk process?
- ◆ **Project complexity.** Is a robust risk approach demanded by high levels of innovation, new technology, commercial arrangements, interfaces, or external dependencies that increase project complexity? Or is the project simple enough that a reduced risk process will suffice?
- ◆ **Project importance.** How strategically important is the project? Is the level of risk increased for this project because it aims to produce breakthrough opportunities, addresses significant blocks to organizational performance, or involves major product innovation?
- ◆ **Development approach.** Is this a waterfall project, where risk processes can be followed sequentially and iteratively, or does the project follow an agile approach where risk is addressed at the start of each iteration as well as during its execution?

Tailoring of the Project Risk Management processes to meet these considerations is part of the Plan Risk Management process, and the outcomes of tailoring decisions are recorded in the risk management plan.

CONSIDERATIONS FOR AGILE/ADAPTIVE ENVIRONMENTS

High-variability environments, by definition, incur more uncertainty and risk. To address this, projects managed using adaptive approaches make use of frequent reviews of incremental work products and cross-functional project teams to accelerate knowledge sharing and ensure that risk is understood and managed. Risk is considered when selecting the content of each iteration, and risks will also be identified, analyzed, and managed during each iteration.

Additionally, the requirements are kept as a living document that is updated regularly, and work may be reprioritized as the project progresses, based on an improved understanding of current risk exposure.

11.1 PLAN RISK MANAGEMENT

Plan Risk Management is the process of defining how to conduct risk management activities for a project. The key benefit of this process is that it ensures that the degree, type, and visibility of risk management are proportionate to both risks and the importance of the project to the organization and other stakeholders. This process is performed once or at predefined points in the project. The inputs, tools and techniques, and outputs of the process are depicted in Figure 11-2. Figure 11-3 depicts the data flow diagram for the process.

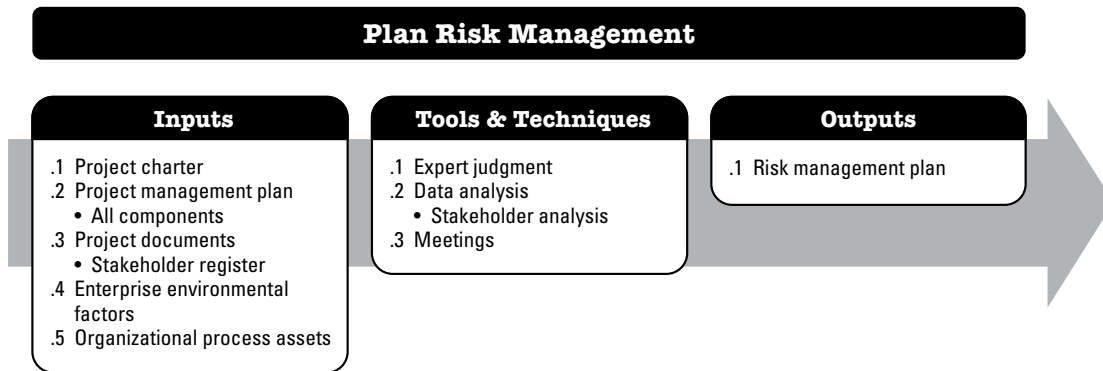

Figure 11-2. Plan Risk Management: Inputs, Tools & Techniques, and Outputs

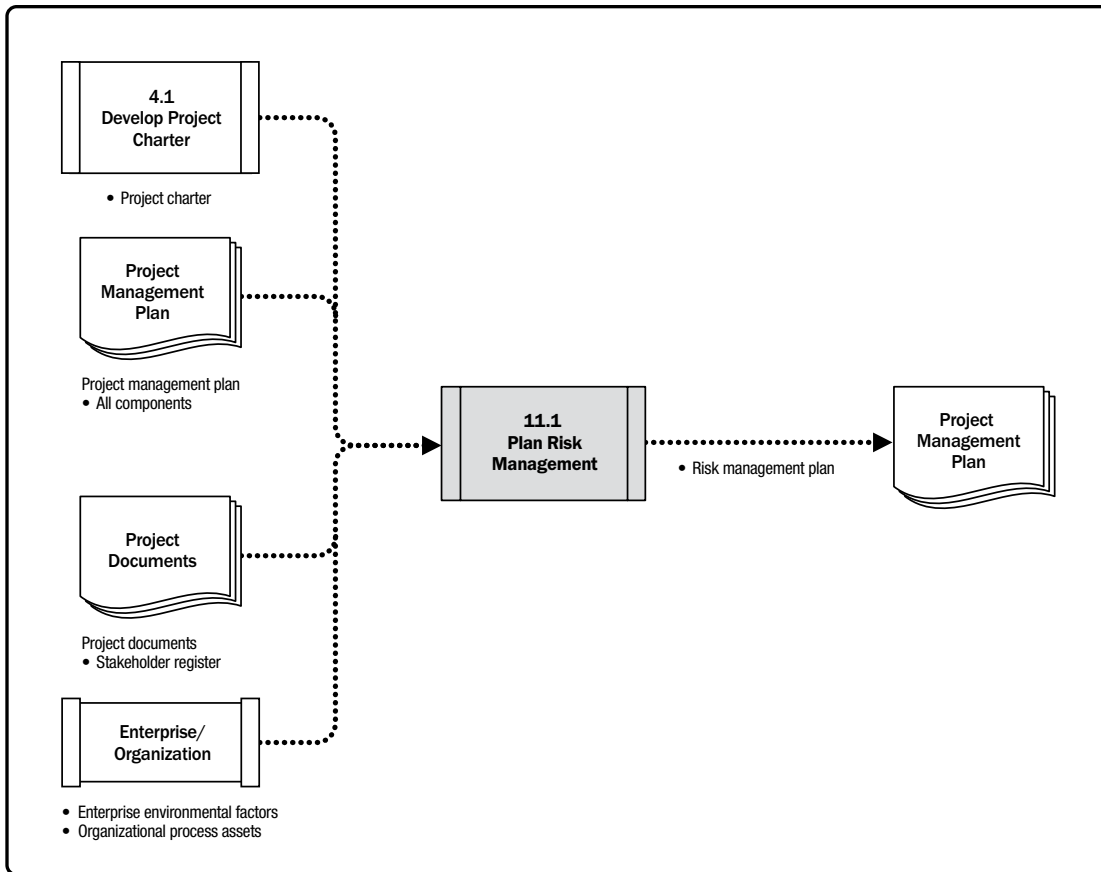

Figure 11-3. Plan Risk Management: Data Flow Diagram

The Plan Risk Management process should begin when a project is conceived and should be completed early in the project. It may be necessary to revisit this process later in the project life cycle, for example at a major phase change, or if the project scope changes significantly, or if a subsequent review of risk management effectiveness determines that the Project Risk Management process requires modification.

11.1.1 PLAN RISK MANAGEMENT: INPUTS

11.1.1.1 PROJECT CHARTER

Described in Section 4.1.3.1. The project charter documents the high-level project description and boundaries, high-level requirements, and risks.

11.1.1.2 PROJECT MANAGEMENT PLAN

Described in Section 4.2.3.1. In planning Project Risk Management, all approved subsidiary management plans should be taken into consideration in order to make the risk management plan consistent with them. The methodology outlined in other project management plan components might influence the Plan Risk Management process.

11.1.1.3 PROJECT DOCUMENTS

Project documents that can be considered as inputs for this process include but are not limited to the stakeholder register as described in Section 13.1.3.1. The stakeholder register contains details of the project's stakeholders and provides an overview of their project roles and their attitude toward risk on this project. This is useful in determining roles and responsibilities for managing risk on the project, as well as setting risk thresholds for the project.

11.1.1.4 ENTERPRISE ENVIRONMENTAL FACTORS

The enterprise environmental factors that can influence the Plan Risk Management process include but are not limited to overall risk thresholds set by the organization or key stakeholders.

11.1.1.5 ORGANIZATIONAL PROCESS ASSETS

The organizational process assets that can influence the Plan Risk Management process include but are not limited to:

- ◆ Organizational risk policy;
- ◆ Risk categories, possibly organized into a risk breakdown structure;
- ◆ Common definitions of risk concepts and terms;
- ◆ Risk statement formats;
- ◆ Templates for the risk management plan, risk register, and risk report;
- ◆ Roles and responsibilities;
- ◆ Authority levels for decision making; and
- ◆ Lessons learned repository from previous similar projects.

11.1.2 PLAN RISK MANAGEMENT: TOOLS AND TECHNIQUES

11.1.2.1 EXPERT JUDGMENT

Described in Section 4.1.2.1. Expertise should be considered from individuals or groups with specialized knowledge or training in the following topics:

- ◆ Familiarity with the organization's approach to managing risk, including enterprise risk management where this is performed;
- ◆ Tailoring risk management to the specific needs of a project; and
- ◆ Types of risk that are likely to be encountered on projects in the same area.

11.1.2.2 DATA ANALYSIS

Data analysis techniques that can be used for this process includes but are not limited to a stakeholder analysis (Section 13.1.2.3) to determine the risk appetite of project stakeholders.

11.1.2.3 MEETINGS

The risk management plan may be developed as part of the project kick-off meeting or a specific planning meeting may be held. Attendees may include the project manager, selected project team members, key stakeholders, or team members who are responsible to manage the risk management process on the project. Others outside the organization may also be invited, as needed, including customers, sellers, and regulators. A skilled facilitator can help participants remain focused on the task, agree on key aspects of the risk approach, identify and overcome sources of bias, and resolve any disagreements that may arise.

Plans for conducting risk management activities are defined in these meetings and documented in the risk management plan (see Section 11.1.3.1).

11.1.3 PLAN RISK MANAGEMENT: OUTPUTS

11.1.3.1 RISK MANAGEMENT PLAN

The risk management plan is a component of the project management plan that describes how risk management activities will be structured and performed. The risk management plan may include some or all of the following elements:

- ◆ **Risk strategy.** Describes the general approach to managing risk on this project.
- ◆ **Methodology.** Defines the specific approaches, tools, and data sources that will be used to perform risk management on the project.
- ◆ **Roles and responsibilities.** Defines the lead, support, and risk management team members for each type of activity described in the risk management plan, and clarifies their responsibilities.
- ◆ **Funding.** Identifies the funds needed to perform activities related to Project Risk Management. Establishes protocols for the application of contingency and management reserves.
- ◆ **Timing.** Defines when and how often the Project Risk Management processes will be performed throughout the project life cycle, and establishes risk management activities for inclusion into the project schedule.
- ◆ **Risk categories.** Provide a means for grouping individual project risks. A common way to structure risk categories is with a risk breakdown structure (RBS), which is a hierarchical representation of potential sources of risk (see example in Figure 11-4). An RBS helps the project team consider the full range of sources from which individual project risks may arise. This can be useful when identifying risks or when categorizing identified risks. The organization may have a generic RBS to be used for all projects, or there may be several RBS frameworks for different types of projects, or the project may develop a tailored RBS. Where an RBS is not used, an organization may use a custom risk categorization framework, which may take the form of a simple list of categories or a structure based on project objectives.



RBS LEVEL 0	RBS LEVEL 1	RBS LEVEL 2
0. ALL SOURCES OF PROJECT RISK	1. TECHNICAL RISK	1.1 Scope definition
		1.2 Requirements definition
		1.3 Estimates, assumptions, and constraints
		1.4 Technical processes
		1.5 Technology
		1.6 Technical interfaces
		Etc.
	2. MANAGEMENT RISK	2.1 Project management
		2.2 Program/portfolio management
		2.3 Operations management
		2.4 Organization
		2.5 Resourcing
		2.6 Communication
		Etc.
	3. COMMERCIAL RISK	3.1 Contractual terms and conditions
		3.2 Internal procurement
		3.3 Suppliers and vendors
		3.4 Subcontracts
		3.5 Client/customer stability
		3.6 Partnerships and joint ventures
		Etc.
	4. EXTERNAL RISK	4.1 Legislation
		4.2 Exchange rates
		4.3 Site/facilities
4.4 Environmental/weather		
4.5 Competition		
4.6 Regulatory		
Etc.		

Figure 11-4. Extract from Sample Risk Breakdown Structure (RBS)

- ◆ **Stakeholder risk appetite.** The risk appetites of key stakeholders on the project are recorded in the risk management plan, as they inform the details of the Plan Risk Management process. In particular, stakeholder risk appetite should be expressed as measurable risk thresholds around each project objective. These thresholds will determine the acceptable level of overall project risk exposure, and they are also used to inform the definitions of probability and impacts to be used when assessing and prioritizing individual project risks.
- ◆ **Definitions of risk probability and impacts.** Definitions of risk probability and impact levels are specific to the project context and reflect the risk appetite and thresholds of the organization and key stakeholders. The project may generate specific definitions of probability and impact levels or it may start with general definitions provided by the organization. The number of levels reflects the degree of detail required for the Project Risk Management process, with more levels used for a more detailed risk approach (typically five levels), and fewer for a simple process (usually three). Table 11-1 provides an example of definitions of probability and impacts against three project objectives. These scales can be used to evaluate both threats and opportunities by interpreting the impact definitions as negative for threats (delay, additional cost, and performance shortfall) and positive for opportunities (reduced time or cost, and performance enhancement).

Table 11-1. Example of Definitions for Probability and Impacts

SCALE	PROBABILITY	+/- IMPACT ON PROJECT OBJECTIVES		
		TIME	COST	QUALITY
Very High	>70%	>6 months	>\$5M	Very significant impact on overall functionality
High	51-70%	3-6 months	\$1M-\$5M	Significant impact on overall functionality
Medium	31-50%	1-3 months	\$501K-\$1M	Some impact in key functional areas
Low	11-30%	1-4 weeks	\$100K-\$500K	Minor impact on overall functionality
Very Low	1-10%	1 week	<\$100K	Minor impact on secondary functions
Nil	<1%	No change	No change	No change in functionality

- ◆ **Probability and impact matrix.** Described in Section 11.3.2.6. Prioritization rules may be specified by the organization in advance of the project and be included in organizational process assets, or they may be tailored to the specific project. Opportunities and threats are represented in a common probability and impact matrix using positive definitions of impact for opportunities and negative impact definitions for threats. Descriptive terms (such as very high, high, medium, low, and very low) or numeric values can be used for probability and impact. Where numeric values are used, these can be multiplied to give a probability-impact score for each risk, which allows the relative priority of individual risks to be evaluated within each priority level. An example probability and impact matrix is presented in Figure 11-5, which also shows a possible numeric risk scoring scheme.

		Threats					Opportunities						
Probability	Very High 0.90	0.05	0.09	0.18	0.36	0.72	0.72	0.36	0.18	0.09	0.05	Very High 0.90	
	High 0.70	0.04	0.07	0.14	0.28	0.56	0.56	0.28	0.14	0.07	0.04	High 0.70	
	Medium 0.50	0.03	0.05	0.10	0.20	0.40	0.40	0.20	0.10	0.05	0.03	Medium 0.50	
	Low 0.30	0.02	0.03	0.06	0.12	0.24	0.24	0.12	0.06	0.03	0.02	Low 0.30	
	Very Low 0.10	0.01	0.01	0.02	0.04	0.08	0.08	0.04	0.02	0.01	0.01	Very Low 0.10	
		Very Low 0.05	Low 0.10	Moderate 0.20	High 0.40	Very High 0.80	Very High 0.80	High 0.40	Moderate 0.20	Low 0.10	Very Low 0.05		
		Negative Impact					Positive Impact						

Figure 11-5. Example Probability and Impact Matrix with Scoring Scheme

- ◆ **Reporting formats.** Reporting formats define how the outcomes of the Project Risk Management process will be documented, analyzed, and communicated. This section of the risk management plan describes the content and format of the risk register and the risk report, as well as any other required outputs from the Project Risk Management processes.
- ◆ **Tracking.** Tracking documents how risk activities will be recorded and how risk management processes will be audited.

11.2 IDENTIFY RISKS

Identify Risks is the process of identifying individual project risks as well as sources of overall project risk, and documenting their characteristics. The key benefit of this process is the documentation of existing individual project risks and the sources of overall project risk. It also brings together information so the project team can respond appropriately to identified risks. This process is performed throughout the project. The inputs, tools and techniques, and outputs of the process are depicted in Figure 11-6. Figure 11-7 depicts the data flow diagram for the process.

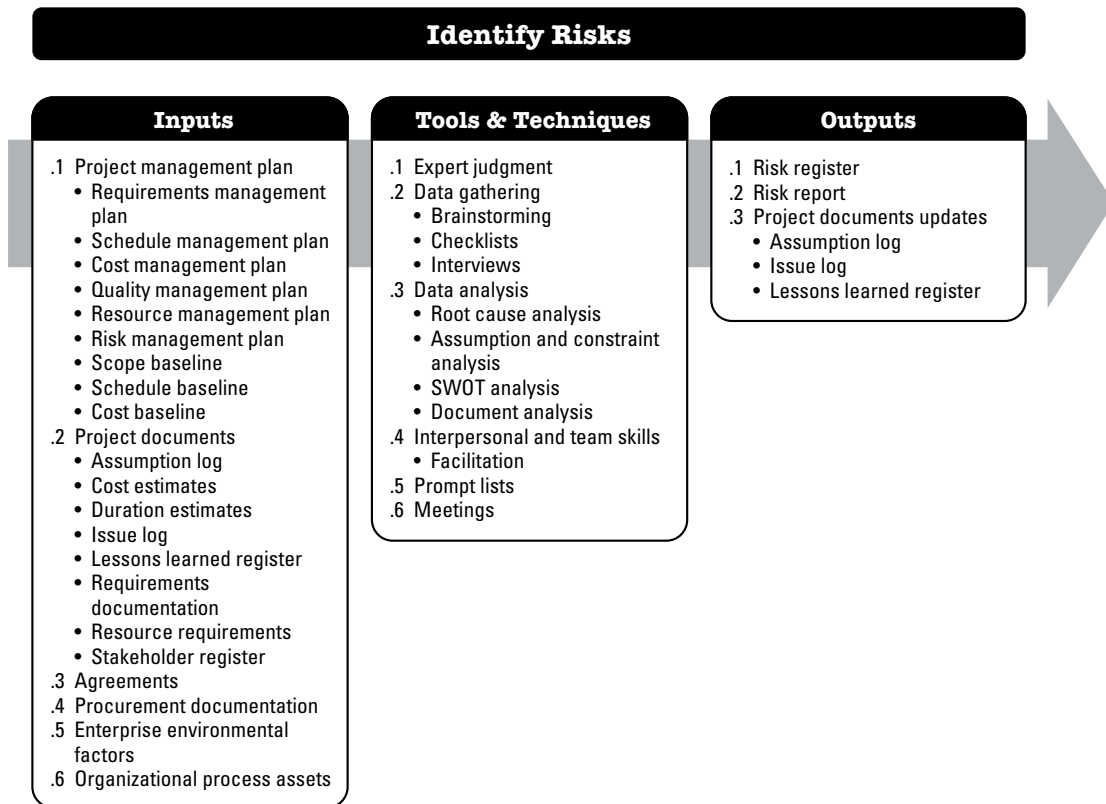

Figure 11-6. Identify Risks: Inputs, Tools & Techniques, and Outputs

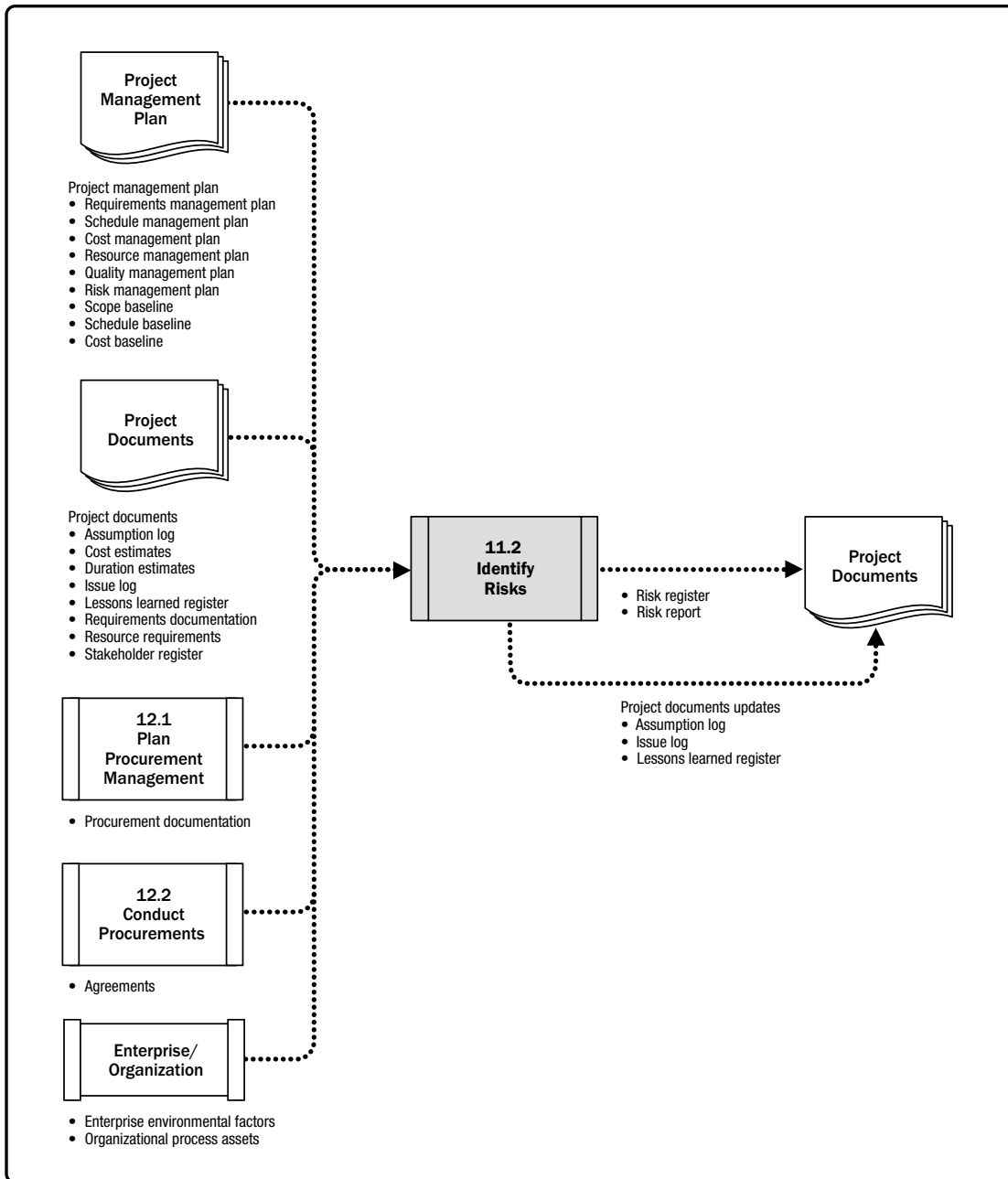

Figure 11-7. Identify Risks: Data Flow Diagram

Identify Risks considers both individual project risks and sources of overall project risk. Participants in risk identification activities may include the following: project manager, project team members, project risk specialist (if assigned), customers, subject matter experts from outside the project team, end users, other project managers, operations managers, stakeholders, and risk management experts within the organization. While these personnel are often key participants for risk identification, all project stakeholders should be encouraged to identify individual project risks. It is particularly important to involve the project team so they can develop and maintain a sense of ownership and responsibility for identified individual project risks, the level of overall project risk, and associated risk response actions.

When describing and recording individual project risks, a consistent format should be used for risk statements to ensure that each risk is understood clearly and unambiguously in order to support effective analysis and risk response development. Risk owners for individual project risks may be nominated as part of the Identify Risks process, and will be confirmed during the Perform Qualitative Risk Analysis process. Preliminary risk responses may also be identified and recorded and will be reviewed and confirmed as part of the Plan Risk Responses process.

Identify Risks is an iterative process, since new individual project risks may emerge as the project progresses through its life cycle and the level of overall project risk will also change. The frequency of iteration and participation in each risk identification cycle will vary by situation, and this will be defined in the risk management plan.

11.2.1 IDENTIFY RISKS: INPUTS

11.2.1.1 PROJECT MANAGEMENT PLAN

Described in Section 4.2.3.1. Project management plan components include but are not limited to:

- ◆ **Requirements management plan.** Described in Section 5.1.3.2. The requirements management plan may indicate project objectives that are particularly at risk.
- ◆ **Schedule management plan.** Described in Section 6.1.3.1. The schedule management plan may identify areas that are subject to uncertainty or ambiguity.
- ◆ **Cost management plan.** Described in Section 7.1.3.1. The cost management plan may identify areas that are subject to uncertainty or ambiguity.
- ◆ **Quality management plan.** Described in Section 8.1.3.1. The quality management plan may identify areas that are subject to uncertainty or ambiguity, or where key assumptions have been made that might give rise to risk.
- ◆ **Resource management plan.** Described in Section 9.1.3.1. The resource management plan may identify areas that are subject to uncertainty or ambiguity, or where key assumptions have been made that might give rise to risk.

- ◆ **Risk management plan.** Described in Section 11.1.3.1. The risk management plan provides information on risk-related roles and responsibilities, indicates how risk management activities are included in the budget and schedule, and describes categories of risk, which may be expressed as a risk breakdown structure (Figure 11-4).
- ◆ **Scope baseline.** Described in Section 5.4.3.1. The scope baseline includes deliverables and criteria for their acceptance, some of which might give rise to risk. It also contains the WBS, which can be used as a framework to structure risk identification techniques.
- ◆ **Schedule baseline.** Described in Section 6.5.3.1. The schedule baseline may be reviewed to identify milestones and deliverable due dates that are subject to uncertainty or ambiguity, or where key assumptions have been made that might give rise to risk.
- ◆ **Cost baseline.** Described in Section 7.3.3.1. The cost baseline may be reviewed to identify costs or funding requirements that are subject to uncertainty or ambiguity, or where key assumptions have been made that might give rise to risk.

11.2.1.2 PROJECT DOCUMENTS

Project documents that can be considered as inputs for this process include but are not limited to:

- ◆ **Assumption log.** Described in Section 4.1.3.2. Assumptions and constraints recorded in the assumption log may give rise to individual project risks and may also influence the level of overall project risk.
- ◆ **Cost estimates.** Described in Section 7.2.3.1. Cost estimates provide quantitative assessments of project costs, ideally expressed as a range, indicating the degree of risk, where a structured review of the documents may indicate that the current estimate is insufficient and poses a risk to the project.
- ◆ **Duration estimates.** Described in Section 6.4.3.1. Duration estimates provide quantitative assessments of project durations, ideally expressed as a range, indicating the degree of risk, where a structured review of the documents may indicate that the current estimate is insufficient and poses a risk to the project.
- ◆ **Issue log.** Described in Section 4.3.3.3. Issues recorded in the issue log may give rise to individual project risks and may also influence the level of overall project risk.
- ◆ **Lessons learned register.** Described in Section 4.4.3.1. Lessons learned about risk identified from earlier phases of the project are reviewed to determine whether similar risks might recur during the remainder of the project.
- ◆ **Requirements documentation.** Described in Section 5.2.3.1. Requirements documentation lists the project requirements and allows the team to identify those that could be at risk.

- ◆ **Resource requirements.** Described in Section 9.2.3.1. Resource requirements provide quantitative assessments of project resource requirements, ideally expressed as a range, indicating the degree of risk, where a structured review of the documents may indicate that the current estimate is insufficient and poses a risk to the project.
- ◆ **Stakeholder register.** Described in Section 13.1.3.1. The stakeholder register indicates which individuals or groups might participate in identifying risks to the project. It also details those individuals who are available to act as risk owners.

11.2.1.3 AGREEMENTS

Described in Section 12.2.3.2. If the project requires external procurement of resources, the agreements may have information such as milestone dates, contract type, acceptance criteria, and awards and penalties that can present threats or opportunities.

11.2.1.4 PROCUREMENT DOCUMENTATION

Described in Section 12.3.1.4. If the project requires external procurement of resources, the initial procurement documentation should be reviewed as procuring goods and services from outside the organization may increase or decrease overall project risk and may introduce additional individual project risks. As the procurement documentation is updated throughout the project, the most up to date documentation can be reviewed for risks. For example, seller performance reports, approved change requests and information on inspections.

11.2.1.5 ENTERPRISE ENVIRONMENTAL FACTORS

The enterprise environmental factors that can influence the Identify Risks process include but are not limited to:

- ◆ Published material, including commercial risk databases or checklists,
- ◆ Academic studies,
- ◆ Benchmarking results, and
- ◆ Industry studies of similar projects.

11.2.1.6 ORGANIZATIONAL PROCESS ASSETS

The organizational process assets that can influence the Identify Risks process include but are not limited to:

- ◆ Project files, including actual data,
- ◆ Organizational and project process controls,
- ◆ Risk statement formats, and
- ◆ Checklists from previous similar projects.

11.2.2 IDENTIFY RISKS: TOOLS AND TECHNIQUES

11.2.2.1 EXPERT JUDGMENT

Described in Section 4.1.2.1. Expertise should be considered from individuals or groups with specialized knowledge of similar projects or business areas. Such experts should be identified by the project manager and invited to consider all aspects of individual project risks as well as sources of overall project risk, based on their previous experience and areas of expertise. The experts' bias should be taken into account in this process.

11.2.2.2 DATA GATHERING

Data-gathering techniques that can be used for this process include but are not limited to:

- ◆ **Brainstorming.** The goal of brainstorming (see Section 4.1.2.2) is to obtain a comprehensive list of individual project risks and sources of overall project risk. The project team usually performs brainstorming, often with a multidisciplinary set of experts who are not part of the team. Ideas are generated under the guidance of a facilitator, either in a free-form brainstorm session or one that uses more structured techniques. Categories of risk, such as in a risk breakdown structure, can be used as a framework. Particular attention should be paid to ensuring that risks identified through brainstorming are clearly described, since the technique can result in ideas that are not fully formed.
- ◆ **Checklists.** A checklist is a list of items, actions, or points to be considered. It is often used as a reminder. Risk checklists are developed based on historical information and knowledge that has been accumulated from similar projects and from other sources of information. They are an effective way to capture lessons learned from similar completed projects, listing specific individual project risks that have occurred previously and that may be relevant to this project. The organization may maintain a risk checklist based on its own completed projects or may use generic risk checklists from the industry. While a checklist may be quick and simple to use, it is impossible to build an exhaustive one, and care should be taken to ensure the checklist is not used to avoid the effort of proper risk identification. The project team should also explore items that do not appear on the checklist. Additionally, the checklist should be reviewed from time to time to update new information as well as remove or archive obsolete information.
- ◆ **Interviews.** Individual project risks and sources of overall project risk can be identified by interviewing experienced project participants, stakeholders, and subject matter experts. Interviews (see Section 5.2.2.2) should be conducted in an environment of trust and confidentiality to encourage honest and unbiased contributions.

11.2.2.3 DATA ANALYSIS

Data analysis techniques that can be used for this process include but are not limited to:

- ◆ **Root cause analysis.** Root cause analysis (see Section 8.2.2.2) is typically used to discover the underlying causes that lead to a problem, and develop preventive action. It can be used to identify threats by starting with a problem statement (for example, the project might be delayed or over budget) and exploring which threats might result in that problem occurring. The same technique can be used to find opportunities by starting with a benefit statement (for example, early delivery or under budget) and exploring which opportunities might result in that benefit being realized.
- ◆ **Assumption and constraint analysis.** Every project and its project management plan are conceived and developed based on a set of assumptions and within a series of constraints. These are often already incorporated in the scope baseline and project estimates. Assumption and constraint analysis explores the validity of assumptions and constraints to determine which pose a risk to the project. Threats may be identified from the inaccuracy, instability, inconsistency, or incompleteness of assumptions. Constraints may give rise to opportunities through removing or relaxing a limiting factor that affects the execution of a project or process.
- ◆ **SWOT analysis.** This technique examines the project from each of the strengths, weaknesses, opportunities, and threats (SWOT) perspectives. For risk identification, it is used to increase the breadth of identified risks by including internally generated risks. The technique starts with the identification of strengths and weaknesses of the organization, focusing on either the project, organization, or the business area in general. SWOT analysis then identifies any opportunities for the project that may arise from strengths, and any threats resulting from weaknesses. The analysis also examines the degree to which organizational strengths may offset threats and determines if weaknesses might hinder opportunities.
- ◆ **Document analysis.** Described in Section 5.2.2.3. Risks may be identified from a structured review of project documents, including, but not limited to, plans, assumptions, constraints, previous project files, contracts, agreements, and technical documentation. Uncertainty or ambiguity in project documents, as well as inconsistencies within a document or between different documents, may be indicators of risk on the project.

11.2.2.4 INTERPERSONAL AND TEAM SKILLS

Interpersonal and team skills that can be used for this process includes but are not limited to facilitation (see Section 4.1.2.3). Facilitation improves the effectiveness of many of the techniques used to identify individual project risks and sources of overall project risk. A skilled facilitator can help participants remain focused on the risk identification task, follow the method associated with the technique accurately, ensure clear risk descriptions, identify and overcome sources of bias, and resolve any disagreements that may arise.

11.2.2.5 PROMPT LISTS

A prompt list is a predetermined list of risk categories that might give rise to individual project risks and that could also act as sources of overall project risk. The prompt list can be used as a framework to aid the project team in idea generation when using risk identification techniques. The risk categories in the lowest level of the risk breakdown structure can be used as a prompt list for individual project risks. Some common strategic frameworks are more suitable for identifying sources of overall project risk, for example PESTLE (political, economic, social, technological, legal, environmental), TECOP (technical, environmental, commercial, operational, political), or VUCA (volatility, uncertainty, complexity, ambiguity).

11.2.2.6 MEETINGS

To undertake risk identification, the project team may conduct a specialized meeting (often called a risk workshop). Most risk workshops include some form of brainstorming (see Section 4.1.2.2), but other risk identification techniques may be included depending on the level of the risk process defined in the risk management plan. Use of a skilled facilitator will increase the effectiveness of the meeting. It is also essential to ensure that the right people participate in the risk workshop. On larger projects, it may be appropriate to invite the project sponsor, subject matter experts, sellers, representatives of the customer, or other project stakeholders. Risk workshops for smaller projects may be restricted to a subset of the project team.

11.2.3 IDENTIFY RISKS: OUTPUTS

11.2.3.1 RISK REGISTER

The risk register captures details of identified individual project risks. The results of Perform Qualitative Risk Analysis, Plan Risk Responses, Implement Risk Responses, and Monitor Risks are recorded in the risk register as those processes are conducted throughout the project. The risk register may contain limited or extensive risk information depending on project variables such as size and complexity.

On completion of the Identify Risks process, the content of the risk register may include but is not limited to:

- ◆ **List of identified risks.** Each individual project risk is given a unique identifier in the risk register. Identified risks are described in as much detail as required to ensure unambiguous understanding. A structured risk statement may be used to distinguish risks from their cause(s) and their effect(s).
- ◆ **Potential risk owners.** Where a potential risk owner has been identified during the Identify Risks process, the risk owner is recorded in the risk register. This will be confirmed during the Perform Qualitative Risk Analysis process.
- ◆ **List of potential risk responses.** Where a potential risk response has been identified during the Identify Risks process, it is recorded in the risk register. This will be confirmed during the Plan Risk Responses process.

Additional data may be recorded for each identified risk, depending on the risk register format specified in the risk management plan. This may include: a short risk title, risk category, current risk status, one or more causes, one or more effects on objectives, risk triggers (events or conditions that indicate that a risk is about to occur), WBS reference of affected activities, and timing information (when was the risk identified, when might the risk occur, when might it no longer be relevant, and what is the deadline for taking action).



11.2.3.2 RISK REPORT

The risk report presents information on sources of overall project risk, together with summary information on identified individual project risks. The risk report is developed progressively throughout the Project Risk Management process. The results of Perform Qualitative Risk Analysis, Perform Quantitative Risk Analysis, Plan Risk Responses, Implement Risk Responses, and Monitor Risks are also included in the risk report as those processes are completed. On completion of the Identify Risks process, information in the risk report may include but is not limited to:

- ◆ Sources of overall project risk, indicating which are the most important drivers of overall project risk exposure; and
- ◆ Summary information on identified individual project risks, such as number of identified threats and opportunities, distribution of risks across risk categories, metrics and trends, etc.

Additional information may be included in the risk report, depending on the reporting requirements specified in the risk management plan.

11.2.3.3 PROJECT DOCUMENTS UPDATES

Project documents that may be updated as a result of this process include but are not limited to:

- ◆ **Assumption log.** Described in Section 4.1.3.2. During the Identify Risks process, new assumptions may be made, new constraints may be identified, and existing assumptions or constraints may be revisited and changed. The assumption log should be updated with this new information.
- ◆ **Issue log.** Described in Section 4.3.3.3. The issue log should be updated to capture any new issues uncovered or changes in currently logged issues.
- ◆ **Lessons learned register.** Described in Section 4.4.3.1. The lessons learned register can be updated with information on techniques that were effective in identifying risks to improve performance in later phases or other projects.

11.3 PERFORM QUALITATIVE RISK ANALYSIS

Perform Qualitative Risk Analysis is the process of prioritizing individual project risks for further analysis or action by assessing their probability of occurrence and impact as well as other characteristics. The key benefit of this process is that it focuses efforts on high-priority risks. This process is performed throughout the project. The inputs, tools and techniques, and outputs of the process are depicted in Figure 11-8. Figure 11-9 depicts the data flow diagram for the process.

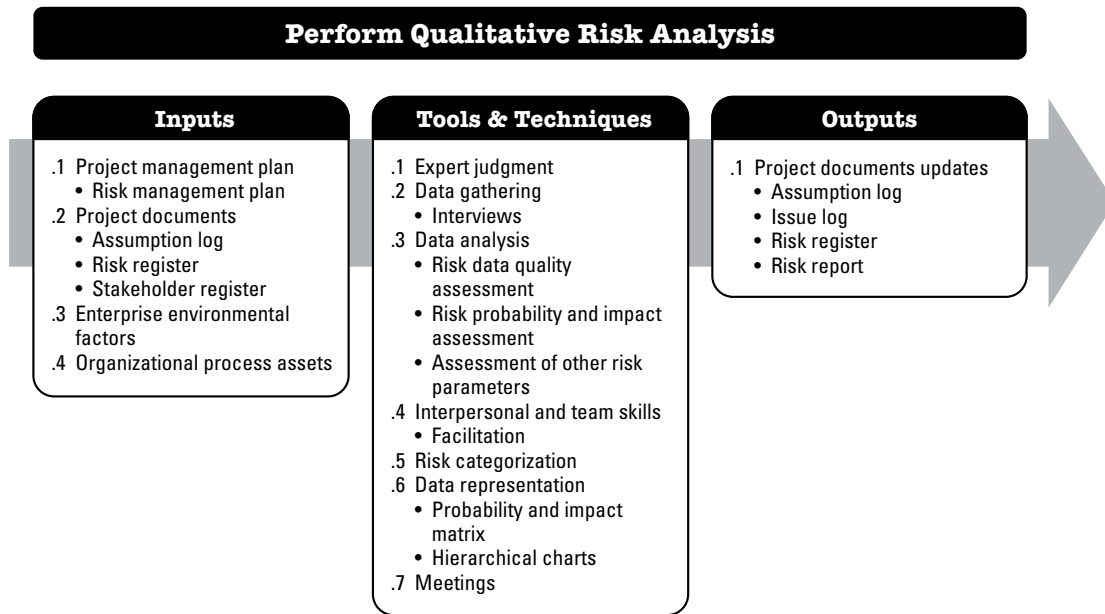

Figure 11-8. Perform Qualitative Risk Analysis: Inputs, Tools & Techniques, and Outputs

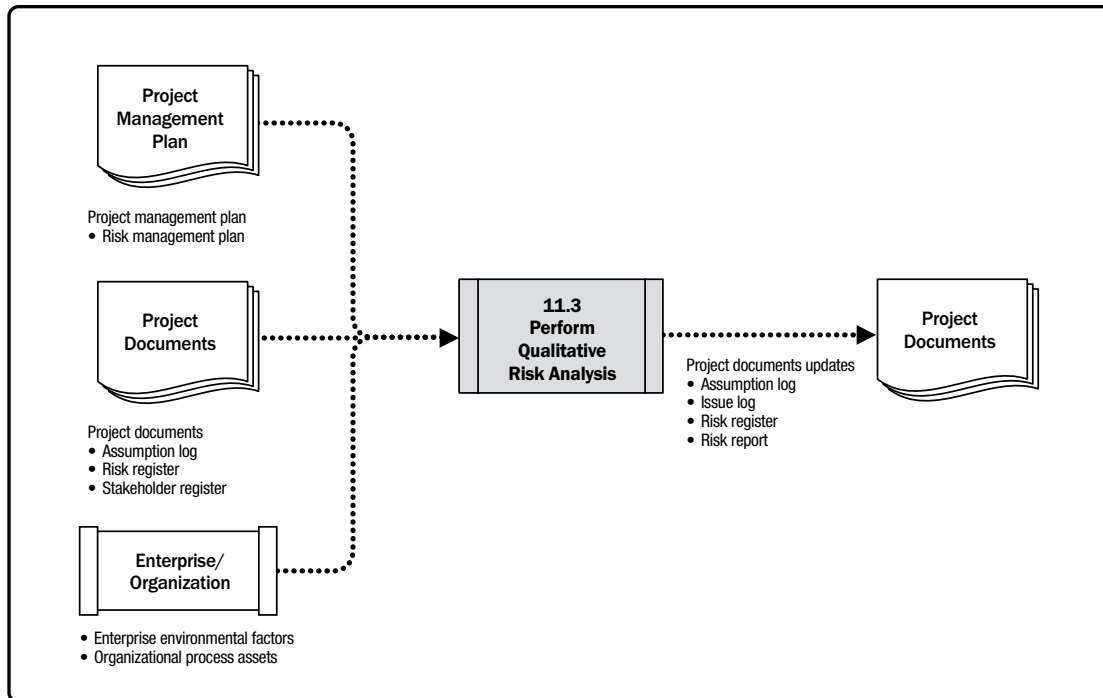

Figure 11-9. Perform Qualitative Risk Analysis: Data Flow Diagram

Perform Qualitative Risk Analysis assesses the priority of identified individual project risks using their probability of occurrence, the corresponding impact on project objectives if the risks occur, and other factors. Such assessments are subjective as they are based on perceptions of risk by the project team and other stakeholders. Effective assessment therefore requires explicit identification and management of the risk attitudes of key participants in the Perform Qualitative Risk Analysis process. Risk perception introduces bias into the assessment of identified risks, so attention should be paid to identifying bias and correcting for it. Where a facilitator is used to support the Perform Qualitative Risk Analysis process, addressing bias is a key part of the facilitator's role. An evaluation of the quality of the available information on individual project risks also helps to clarify the assessment of each risk's importance to the project.

Perform Qualitative Risk Analysis establishes the relative priorities of individual project risks for Plan Risk Responses. It identifies a risk owner for each risk who will take responsibility for planning an appropriate risk response and ensuring that it is implemented. Perform Qualitative Risk Analysis also lays the foundation for Perform Quantitative Risk Analysis if this process is required.

The Perform Qualitative Risk Analysis process is performed regularly throughout the project life cycle, as defined in the risk management plan. Often, in an agile development environment, the Perform Qualitative Risk Analysis process is conducted before the start of each iteration.

11.3.1 PERFORM QUALITATIVE RISK ANALYSIS: INPUTS

11.3.1.1 PROJECT MANAGEMENT PLAN

Described in Section 4.2.3.1. Project management plan components include the risk management plan as described in Section 11.1.3.1. Of particular interest in this process are the roles and responsibilities for conducting risk management, budgets for risk management, schedule activities for risk management, risk categories (often defined in a risk breakdown structure), definitions of probability and impact, the probability and impact matrix, and stakeholders' risk thresholds. These inputs are usually tailored to the project during the Plan Risk Management process. If they are not available, they may be developed during the Perform Qualitative Risk Analysis process and presented to the project sponsor for approval before use.

11.3.1.2 PROJECT DOCUMENTS

Project documents that can be considered as inputs for this process include but are not limited to:

- ◆ **Assumption log.** Described in Section 4.1.3.2. The assumption log is used for identifying, managing, and monitoring key assumptions and constraints that may affect the project. These may inform the assessment of the priority of individual project risks.
- ◆ **Risk register.** Described in Section 11.2.3.1. The risk register contains details of each identified individual project risk that will be assessed during the Perform Qualitative Risk Analysis process.
- ◆ **Stakeholder register.** Described in Section 13.1.3.1. This includes details of project stakeholders who may be nominated as risk owners.

11.3.1.3 ENTERPRISE ENVIRONMENTAL FACTORS

The enterprise environmental factors that can influence Perform Qualitative Risk Analysis include but are not limited to:

- ◆ Industry studies of similar projects, and
- ◆ Published material, including commercial risk databases or checklists.

11.3.1.4 ORGANIZATIONAL PROCESS ASSETS

The organizational process assets that can influence Perform Qualitative Risk Analysis include but are not limited to information from similar completed projects.

11.3.2 PERFORM QUALITATIVE RISK ANALYSIS: TOOLS AND TECHNIQUES

11.3.2.1 EXPERT JUDGMENT

Described in Section 4.1.2.1. Expertise should be considered from individuals or groups with specialized knowledge or training in the following topics:

- ◆ Previous similar projects, and
- ◆ Qualitative risk analysis.

Expert judgment is often obtained through facilitated risk workshops or interviews. The possibility of expert views being biased should be taken into account in this process.

11.3.2.2 DATA GATHERING

Data-gathering techniques that can be used for this process include but are not limited to interviews. Structured or semi-structured interviews (Section 5.2.2.2) can be used to assess the probability and impacts of individual project risks, as well as other factors. The interviewer should promote an environment of trust and confidentiality in the interview setting to encourage honest and unbiased assessments.

11.3.2.3 DATA ANALYSIS

Data analysis techniques that can be used during this process include but are not limited to:

- ◆ **Risk data quality assessment.** Risk data quality assessment evaluates the degree to which the data about individual project risks is accurate and reliable as a basis for qualitative risk analysis. The use of low-quality risk data may lead to a qualitative risk analysis that is of little use to the project. If data quality is unacceptable, it may be necessary to gather better data. Risk data quality may be assessed via a questionnaire measuring the project's stakeholder perceptions of various characteristics, which may include completeness, objectivity, relevancy, and timeliness. A weighted average of selected data quality characteristics can then be generated to give an overall quality score.
- ◆ **Risk probability and impact assessment.** Risk probability assessment considers the likelihood that a specific risk will occur. Risk impact assessment considers the potential effect on one or more project objectives such as schedule, cost, quality, or performance. Impacts will be negative for threats and positive for opportunities. Probability and impact are assessed for each identified individual project risk. Risks can be assessed in interviews or meetings with participants selected for their familiarity with the types of risk recorded in the risk register. Project team members and knowledgeable persons external to the project are included. The level of probability for each risk and its impact on each objective are evaluated during the interview or meeting. Differences in the levels of probability and impact perceived by stakeholders are to be expected, and such differences should be explored. Explanatory detail, including assumptions justifying the levels assigned, are also recorded. Risk probabilities and impacts are assessed using the definitions given in the risk management plan (see Table 11-1). Risks with low probability and impact may be included within the risk register as part of a watch list for future monitoring.
- ◆ **Assessment of other risk parameters.** The project team may consider other characteristics of risk (in addition to probability and impact) when prioritizing individual project risks for further analysis and action. These characteristics may include but are not limited to:

- *Urgency.* The period of time within which a response to the risk is to be implemented in order to be effective. A short period indicates high urgency.
- *Proximity.* The period of time before the risk might have an impact on one or more project objectives. A short period indicates high proximity.
- *Dormancy.* The period of time that may elapse after a risk has occurred before its impact is discovered. A short period indicates low dormancy.
- *Manageability.* The ease with which the risk owner (or owning organization) can manage the occurrence or impact of a risk. Where management is easy, manageability is high.
- *Controllability.* The degree to which the risk owner (or owning organization) is able to control the risk's outcome. Where the outcome can be easily controlled, controllability is high.
- *Detectability.* The ease with which the results of the risk occurring, or being about to occur, can be detected and recognized. Where the risk occurrence can be detected easily, detectability is high.
- *Connectivity.* The extent to which the risk is related to other individual project risks. Where a risk is connected to many other risks, connectivity is high.
- *Strategic impact.* The potential for the risk to have a positive or negative effect on the organization's strategic goals. Where the risk has a major effect on strategic goals, strategic impact is high.
- *Propinquity.* The degree to which a risk is perceived to matter by one or more stakeholders. Where a risk is perceived as very significant, propinquity is high.

The consideration of some of these characteristics can provide a more robust prioritization of risks than is possible by only assessing probability and impact.

11.3.2.4 INTERPERSONAL AND TEAM SKILLS

Interpersonal and team skills that can be used for this process include but are not limited to facilitation (see Section 4.1.2.3). Facilitation improves the effectiveness of the qualitative analysis of individual project risks. A skilled facilitator can help participants remain focused on the risk analysis task, follow the method associated with the technique accurately, reach consensus on assessments of probability and impacts, identify and overcome sources of bias, and resolve any disagreements that may arise.

11.3.2.5 RISK CATEGORIZATION

Risks to the project can be categorized by sources of risk (e.g., using the risk breakdown structure (RBS); see Figure 11-4), the area of the project affected (e.g., using the work breakdown structure (WBS); see Figures 5-12, 5-13, and 5-14), or other useful categories (e.g., project phase, project budget, and roles and responsibilities) to determine the areas of the project most exposed to the effects of uncertainty. Risks can also be categorized by common root causes. Risk categories that may be used for the project are defined in the risk management plan.

Grouping risks into categories can lead to the development of more effective risk responses by focusing attention and effort on the areas of highest risk exposure, or by developing generic risk responses to address groups of related risks.

11.3.2.6 DATA REPRESENTATION

Data representation techniques that can be used during this process include but are not limited to:

- ◆ **Probability and impact matrix.** A probability and impact matrix is a grid for mapping the probability of each risk occurrence and its impact on project objectives if that risk occurs. This matrix specifies combinations of probability and impact that allow individual project risks to be divided into priority groups (see Figure 11-5). Risks can be prioritized for further analysis and planning of risk responses based on their probability and impacts. The probability of occurrence for each individual project risk is assessed as well as its impact on one or more project objectives if it does occur, using definitions of probability and impact for the project as specified in the risk management plan. Individual project risks are assigned to a priority level based on the combination of their assessed probability and impact, using a probability and impact matrix.

An organization can assess a risk separately for each objective (e.g., cost, time, and scope) by having a separate probability and impact matrix for each. Alternatively, it may develop ways to determine one overall priority level for each risk, either by combining assessments for different objectives, or by taking the highest priority level regardless of which objective is affected.

- ◆ **Hierarchical charts.** Where risks have been categorized using more than two parameters, the probability and impact matrix cannot be used and other graphical representations are required. For example, a bubble chart displays three dimensions of data, where each risk is plotted as a disk (bubble), and the three parameters are represented by the x-axis value, the y-axis value, and the bubble size. An example bubble chart is shown in Figure 11-10, with detectability and proximity plotted on the x and y axes, and impact value represented by bubble size.

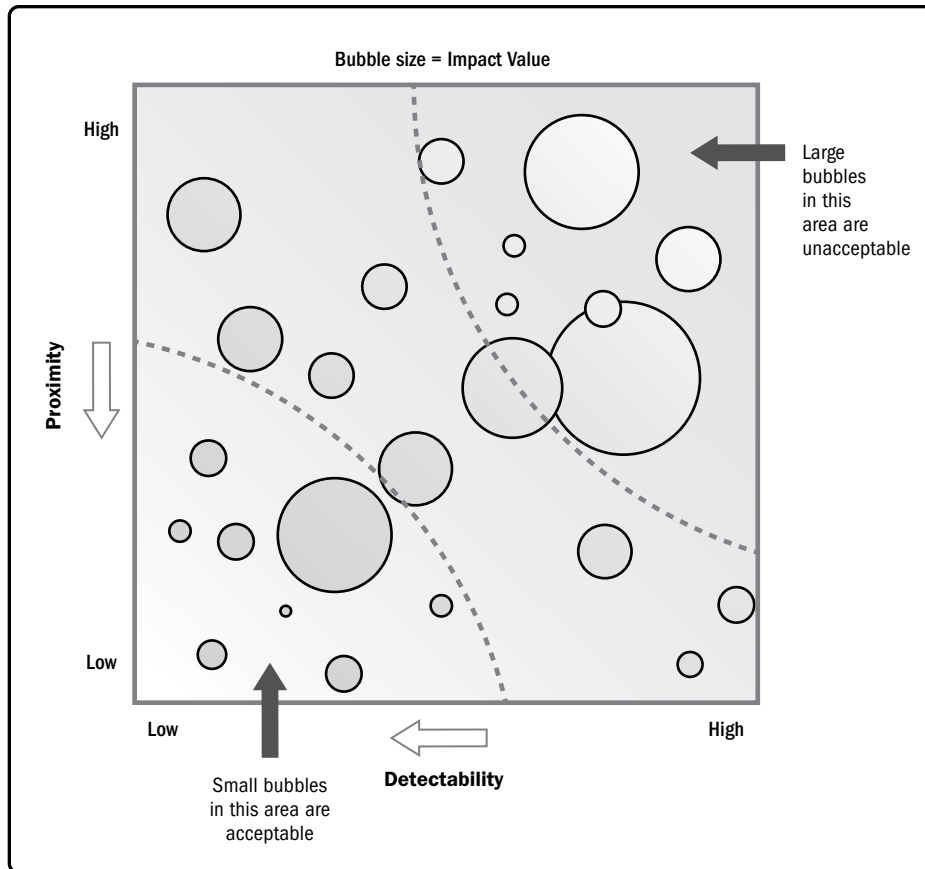

Figure 11-10. Example Bubble Chart Showing Detectability, Proximity, and Impact Value

11.3.2.7 MEETINGS

To undertake qualitative risk analysis, the project team may conduct a specialized meeting (often called a risk workshop) dedicated to the discussion of identified individual project risks. The goals of this meeting include the review of previously identified risks, assessment of probability and impacts (and possibly other risk parameters), categorization, and prioritization. A risk owner, who will be responsible for planning an appropriate risk response and for reporting progress on managing the risk, will be allocated to each individual project risk as part of the Perform Qualitative Risk Analysis process. The meeting may start by reviewing and confirming the probability and impact scales to be used for the analysis. The meeting may also identify additional risks during the discussion, and these should be recorded for analysis. Use of a skilled facilitator will increase the effectiveness of the meeting.

11.3.3 PERFORM QUALITATIVE RISK ANALYSIS: OUTPUTS

11.3.3.1 PROJECT DOCUMENTS UPDATES

Project documents that may be updated as a result of carrying out this process include but are not limited to:

- ◆ **Assumption log.** Described in Section 4.1.3.2. During the Perform Qualitative Risk Analysis process, new assumptions may be made, new constraints may be identified, and existing assumptions or constraints may be revisited and changed. The assumption log should be updated with this new information.
- ◆ **Issue log.** Described in Section 4.3.3.3. The issue log should be updated to capture any new issues uncovered or changes in currently logged issues.
- ◆ **Risk register.** Described in Section 11.2.3.1. The risk register is updated with new information generated during the Perform Qualitative Risk Analysis process. Updates to the risk register may include assessments of probability and impacts for each individual project risk, its priority level or risk score, the nominated risk owner, risk urgency information or risk categorization, and a watch list for low-priority risks or risks requiring further analysis.
- ◆ **Risk report.** Described in Section 11.2.3.2. The risk report is updated to reflect the most important individual project risks (usually those with the highest probability and impact), as well as a prioritized list of all identified risks on the project and a summary conclusion.



11.4 PERFORM QUANTITATIVE RISK ANALYSIS

Perform Quantitative Risk Analysis is the process of numerically analyzing the combined effect of identified individual project risks and other sources of uncertainty on overall project objectives. The key benefit of this process is that it quantifies overall project risk exposure, and it can also provide additional quantitative risk information to support risk response planning. This process is not required for every project, but where it is used, it is performed throughout the project. The inputs and outputs of this process are depicted in Figure 11-11. Figure 11-12 depicts the data flow diagram for the process.

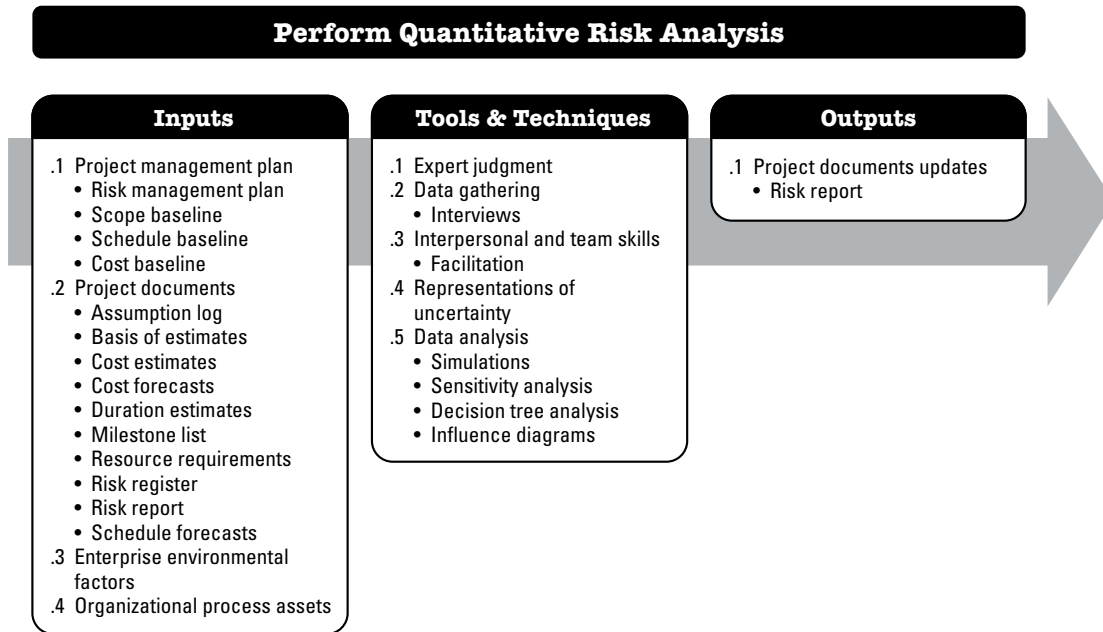

Figure 11-11. Perform Quantitative Risk Analysis: Inputs, Tools & Techniques, and Outputs

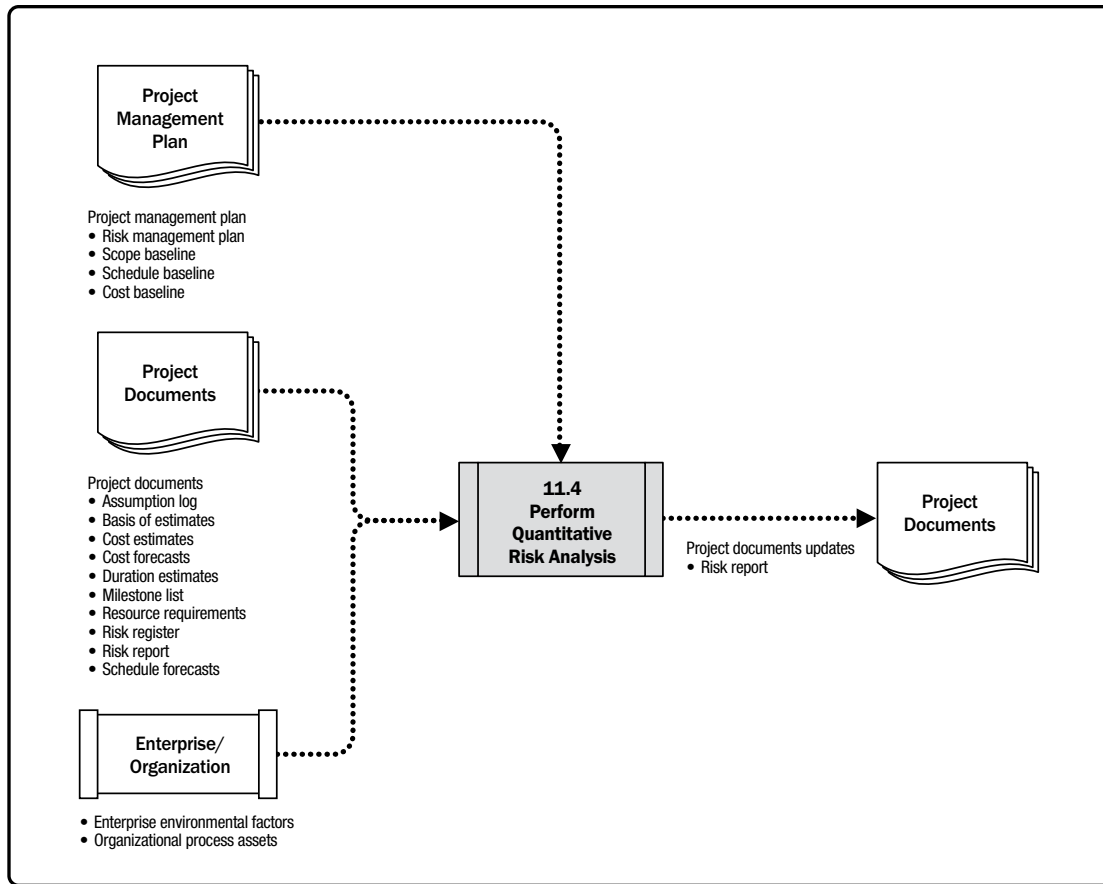

Figure 11-12. Perform Quantitative Risk Analysis: Data Flow Diagram

Perform Quantitative Risk Analysis is not required for all projects. Undertaking a robust analysis depends on the availability of high-quality data about individual project risks and other sources of uncertainty, as well as a sound underlying project baseline for scope, schedule, and cost. Quantitative risk analysis usually requires specialized risk software and expertise in the development and interpretation of risk models. It also consumes additional time and cost. The use of quantitative risk analysis for a project will be specified in the project's risk management plan. It is most likely appropriate for large or complex projects, strategically important projects, projects for which it is a contractual requirement, or projects in which a key stakeholder requires it. Quantitative risk analysis is the only reliable method to assess overall project risk through evaluating the aggregated effect on project outcomes of all individual project risks and other sources of uncertainty.

Perform Quantitative Risk Analysis uses information on individual project risks that have been assessed by the Perform Qualitative Risk Analysis process as having a significant potential to affect the project's objectives.

Outputs from Perform Quantitative Risk Analysis are used as inputs to the Plan Risk Responses process, particularly in recommending responses to the level of overall project risk and key individual risks. A quantitative risk analysis may also be undertaken following the Plan Risk Responses process, to determine the likely effectiveness of planned responses in reducing overall project risk exposure.

11.4.1 PERFORM QUANTITATIVE RISK ANALYSIS: INPUTS

11.4.1.1 PROJECT MANAGEMENT PLAN

Described in Section 4.2.3.1. Project management plan components include but are not limited to:

- ◆ **Risk management plan.** Described in Section 11.1.3.1. The risk management plan specifies whether quantitative risk analysis is required for the project. It also details the resources available for the analysis and the expected frequency of analyses.
- ◆ **Scope baseline.** Described in Section 5.4.3.1. The scope baseline describes the starting point from which the effect of individual project risks and other sources of uncertainty are evaluated.
- ◆ **Schedule baseline.** Described in Section 6.5.3.1. The schedule baseline describes the starting point from which the effect of individual project risks and other sources of uncertainty can be evaluated.
- ◆ **Cost baseline.** Described in Section 7.3.3.1. The cost baseline describes the starting point from which the effect of individual project risks and other sources of uncertainty can be evaluated.

11.4.1.2 PROJECT DOCUMENTS

Project documents that can be considered as inputs for this process include but are not limited to:

- ◆ **Assumption log.** Described in Section 4.1.3.2. Assumptions may form inputs to the quantitative risk analysis if they are assessed as posing a risk to project objectives. The effect of constraints may also be modeled during a quantitative risk analysis.
- ◆ **Basis of estimates.** Described in Sections 6.4.3.2 and 7.2.3.2. The basis of estimates used in the planning of the project may be reflected in variability modeled during a quantitative risk analysis process. This may include information on the estimate's purpose, classification, assumed accuracy, methodology, and source.
- ◆ **Cost estimates.** Described in Section 7.2.3.1. Cost estimates provide the starting point from which cost variability is evaluated.
- ◆ **Cost forecasts.** Described in Section 7.4.3.2. Forecasts such as the project's estimate to complete (ETC), estimate at completion (EAC), budget at completion (BAC), and to-complete performance index (TCPI) may be compared to the results of a quantitative cost risk analysis to determine the confidence level associated with achieving these targets.
- ◆ **Duration estimates.** Described in Section 6.4.3.1. Duration estimates provide the starting point from which schedule variability is evaluated.
- ◆ **Milestone list.** Described in Section 6.2.3.3. Significant events in the project define the schedule targets against which the results of a quantitative schedule risk analysis are compared, in order to determine the confidence level associated with achieving these targets.

- ◆ **Resource requirements.** Described in Section 9.2.3.1. Resource requirements provide the starting point from which variability is evaluated.
- ◆ **Risk register.** Described in Section 11.2.3.1. The risk register contains details of individual project risks to be used as input for quantitative risk analysis.
- ◆ **Risk report.** Described in Section 11.2.3.2. The risk report describes sources of overall project risk and the current overall project risk status.
- ◆ **Schedule forecasts.** Described in Section 6.6.3.2. Forecasts may be compared to the results of a quantitative schedule risk analysis to determine the confidence level associated with achieving these targets.

11.4.1.3 ENTERPRISE ENVIRONMENTAL FACTORS

The enterprise environmental factors that can influence the Perform Quantitative Risk Analysis process include but are not limited to:

- ◆ Industry studies of similar projects, and
- ◆ Published material, including commercial risk databases or checklists.

11.4.1.4 ORGANIZATIONAL PROCESS ASSETS

The organizational process assets that can influence the Perform Quantitative Risk Analysis process include information from similar completed projects.

11.4.2 PERFORM QUANTITATIVE RISK ANALYSIS: TOOLS AND TECHNIQUES

11.4.2.1 EXPERT JUDGMENT

Described in Section 4.1.2.1. Expertise should be considered from individuals or groups with specialized knowledge or training in the following topics:

- ◆ Translating information on individual project risks and other sources of uncertainty into numeric inputs for the quantitative risk analysis model,
- ◆ Selecting the most appropriate representation of uncertainty to model particular risks or other sources of uncertainty,
- ◆ Modeling techniques that are appropriate in the context of the project,
- ◆ Identifying which tools would be most suitable for the selected modeling techniques, and
- ◆ Interpreting the outputs of quantitative risk analysis.

11.4.2.2 DATA GATHERING

Interviews (see Section 5.2.2.2) may be used to generate inputs for the quantitative risk analysis, drawing on inputs that include individual project risks and other sources of uncertainty. This is particularly useful where information is required from experts. The interviewer should promote an environment of trust and confidentiality during the interview to encourage honest and unbiased contributions.

11.4.2.3 INTERPERSONAL AND TEAM SKILLS

Interpersonal and team skills that can be used for this process include but are not limited to facilitation (see Section 4.1.2.3). A skilled facilitator is useful for gathering input data during a dedicated risk workshop involving project team members and other stakeholders. Facilitated workshops can improve effectiveness by establishing a clear understanding of the purpose of the workshop, building consensus among participants, ensuring continued focus on the task, and using creative approaches to deal with interpersonal conflict or sources of bias.

11.4.2.4 REPRESENTATIONS OF UNCERTAINTY

Quantitative risk analysis requires inputs to a quantitative risk analysis model that reflect individual project risks and other sources of uncertainty.

Where the duration, cost, or resource requirement for a planned activity is uncertain, the range of possible values can be represented in the model as a probability distribution. This may take several forms. The most commonly used are triangular, normal, lognormal, beta, uniform, or discrete distributions. Care should be taken when selecting an appropriate probability distribution to reflect the range of possible values for the planned activity.

Individual project risks may be covered by probability distributions. Alternatively, risks may be included in the model as probabilistic branches, where optional activities are added to the model to represent the time and/or cost impact of the risk should it occur, and the chance that these activities actually occur in a particular simulation run matches the risk's probability. Branches are most useful for risks that might occur independently of any planned activity. Where risks are related, for example, with a common cause or a logical dependency, correlation is used in the model to indicate this relationship.

Other sources of uncertainty may also be represented using branches to describe alternative paths through the project.

11.4.2.5 DATA ANALYSIS

Data analysis techniques that can be used during this process include but are not limited to:

- ◆ **Simulation.** Quantitative risk analysis uses a model that simulates the combined effects of individual project risks and other sources of uncertainty to evaluate their potential impact on achieving project objectives. Simulations are typically performed using a Monte Carlo analysis. When running a Monte Carlo analysis for cost risk, the simulation uses the project cost estimates. When running a Monte Carlo analysis for schedule risk, the schedule network diagram and duration estimates are used. An integrated quantitative cost-schedule risk analysis uses both inputs. The output is a quantitative risk analysis model.

Computer software is used to iterate the quantitative risk analysis model several thousand times. The input values (e.g., cost estimates, duration estimates, or occurrence of probabilistic branches) are chosen at random for each iteration. Outputs represent the range of possible outcomes for the project (e.g., project end date, project cost at completion). Typical outputs include a histogram presenting the number of iterations where a particular outcome resulted from the simulation, or a cumulative probability distribution (S-curve) representing the probability of achieving any particular outcome or less. An example S-curve from a Monte Carlo cost risk analysis is shown in Figure 11-13.

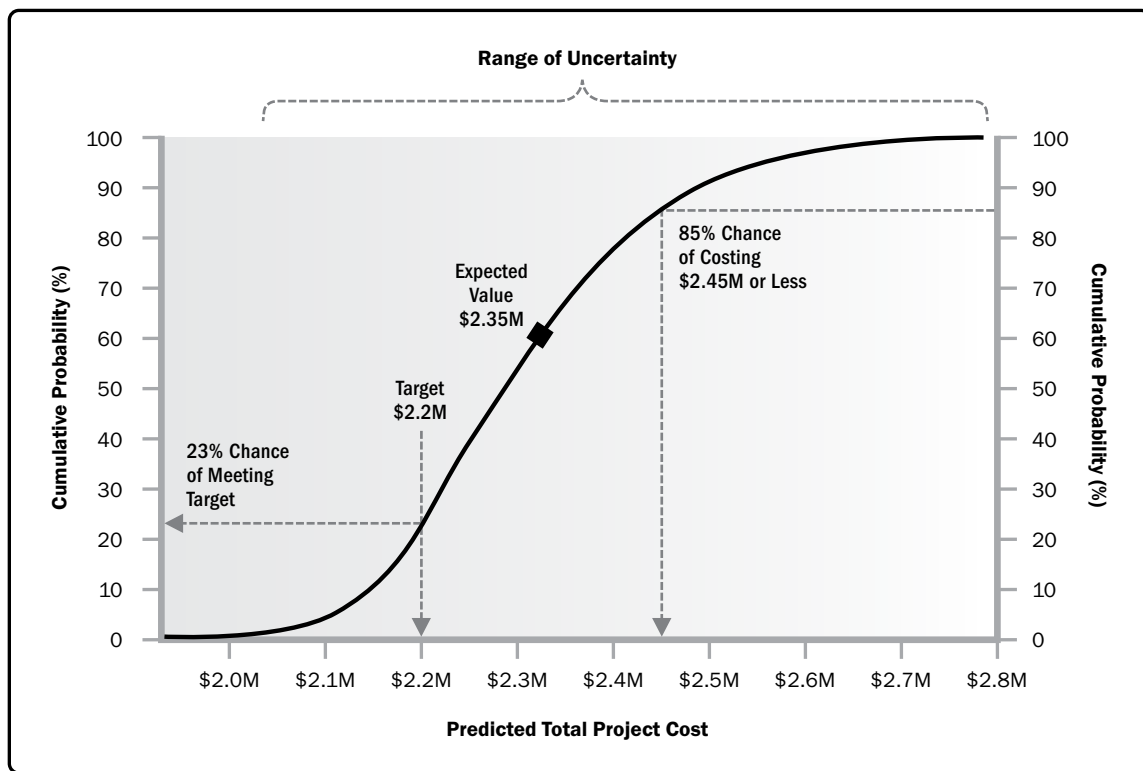

Figure 11-13. Example S-Curve from Quantitative Cost Risk Analysis

For a quantitative schedule risk analysis, it is also possible to conduct a criticality analysis that determines which elements of the risk model have the greatest effect on the project critical path. A criticality index is calculated for each element in the risk model, which gives the frequency with which that element appears on the critical path during the simulation, usually expressed as a percentage. The output from a criticality analysis allows the project team to focus risk response planning efforts on those activities with the highest potential effect on the overall schedule performance of the project.

- ◆ **Sensitivity analysis.** Sensitivity analysis helps to determine which individual project risks or other sources of uncertainty have the most potential impact on project outcomes. It correlates variations in project outcomes with variations in elements of the quantitative risk analysis model.

One typical display of sensitivity analysis is the tornado diagram, which presents the calculated correlation coefficient for each element of the quantitative risk analysis model that can influence the project outcome. This can include individual project risks, project activities with high degrees of variability, or specific sources of ambiguity. Items are ordered by descending strength of correlation, giving the typical tornado appearance. An example tornado diagram is shown in Figure 11-14.

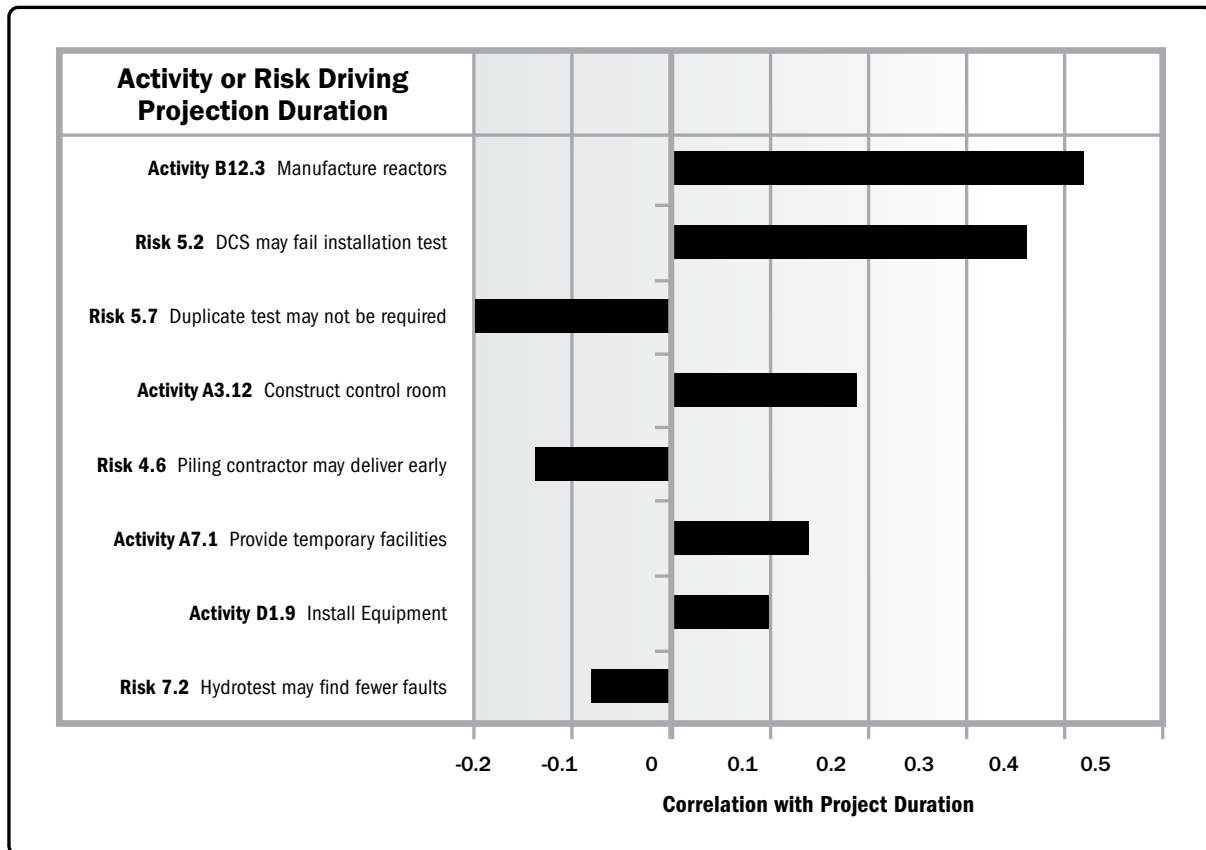

Figure 11-14. Example Tornado Diagram

◆ **Decision tree analysis.** Decision trees are used to support selection of the best of several alternative courses of action. Alternative paths through the project are shown in the decision tree using branches representing different decisions or events, each of which can have associated costs and related individual project risks (including both threats and opportunities). The end-points of branches in the decision tree represent the outcome from following that particular path, which can be negative or positive.

The decision tree is evaluated by calculating the expected monetary value of each branch, allowing the optimal path to be selected. An example decision tree is shown in Figure 11-15.

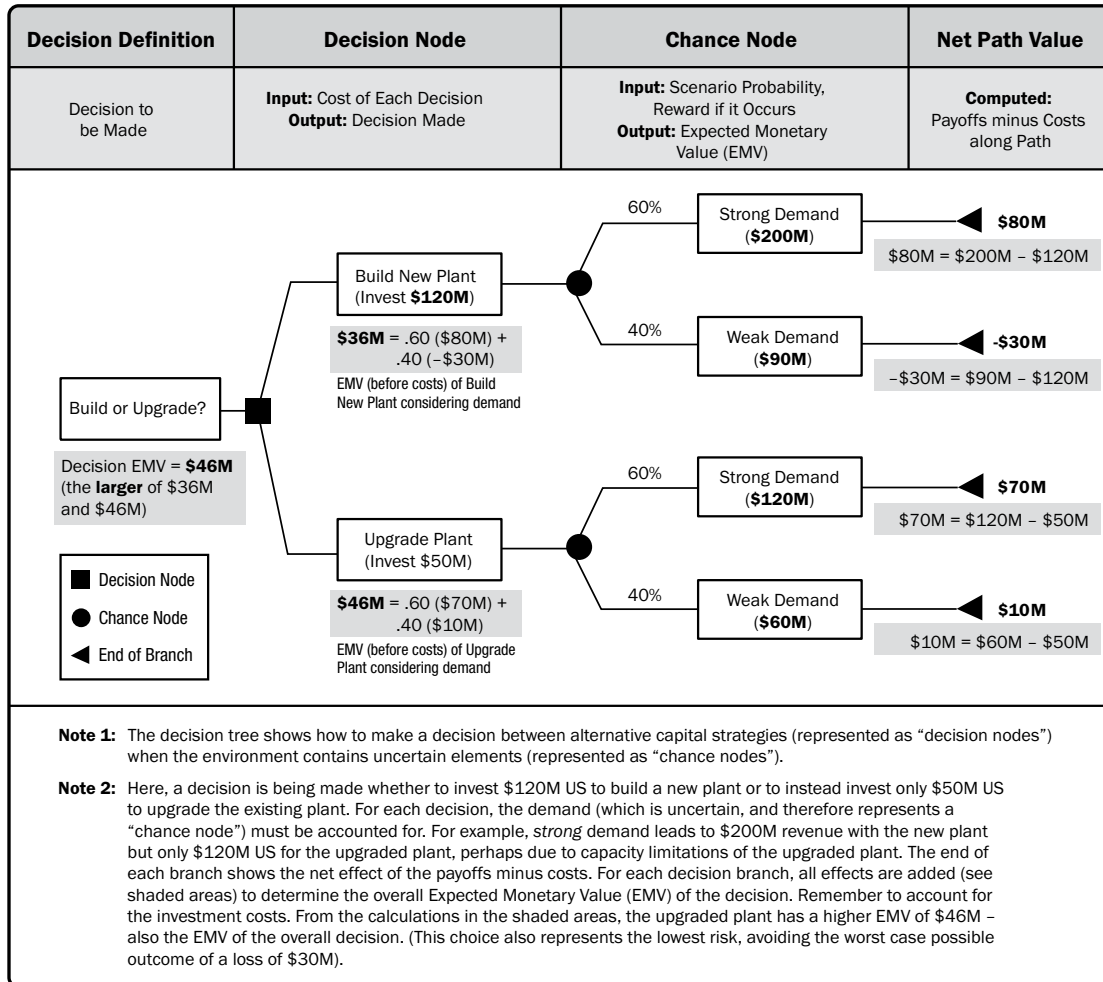

Figure 11-15. Example Decision Tree

- ◆ **Influence diagrams.** Influence diagrams are graphical aids to decision making under uncertainty. An influence diagram represents a project or situation within the project as a set of entities, outcomes, and influences, together with the relationships and effects between them. Where an element in the influence diagram is uncertain as a result of the existence of individual project risks or other sources of uncertainty, this can be represented in the influence diagram using ranges or probability distributions. The influence diagram is then evaluated using a simulation technique, such as Monte Carlo analysis, to indicate which elements have the greatest influence on key outcomes. Outputs from an influence diagram are similar to other quantitative risk analysis methods, including S-curves and tornado diagrams.

11.4.3 PERFORM QUANTITATIVE RISK ANALYSIS: OUTPUTS

11.4.3.1 PROJECT DOCUMENTS UPDATES

Project documents that can be considered as outputs for this process include but are not limited to the risk report described in Section 11.2.3.2. The risk report will be updated to reflect the results of the quantitative risk analysis. This will typically include:

- ◆ **Assessment of overall project risk exposure.** Overall project risk is reflected in two key measures:
 - Chances of project success, indicated by the probability that the project will achieve its key objectives (e.g., required end date or interim milestones, required cost target, etc.) given the identified individual project risks and other sources of uncertainty; and
 - Degree of inherent variability remaining within the project at the time the analysis was conducted, indicated by the range of possible project outcomes.
- ◆ **Detailed probabilistic analysis of the project.** Key outputs from the quantitative risk analysis are presented, such as S-curves, tornado diagrams, and criticality analysis, together with a narrative interpretation of the results. Possible detailed results of a quantitative risk analysis may include:
 - Amount of contingency reserve needed to provide a specified level of confidence;
 - Identification of individual project risks or other sources of uncertainty that have the greatest effect on the project critical path; and
 - Major drivers of overall project risk, with the greatest influence on uncertainty in project outcomes.
- ◆ **Prioritized list of individual project risks.** This list includes those individual project risks that pose the greatest threat or present the greatest opportunity to the project, as indicated by sensitivity analysis.
- ◆ **Trends in quantitative risk analysis results.** As the analysis is repeated at different times during the project life cycle, trends may become apparent that inform the planning of risk responses.
- ◆ **Recommended risk responses.** The risk report may present suggested responses to the level of overall project risk exposure or key individual project risks, based on the results of the quantitative risk analysis. These recommendations will form inputs to the Plan Risk Responses process.

11.5 PLAN RISK RESPONSES

Plan Risk Responses is the process of developing options, selecting strategies, and agreeing on actions to address overall project risk exposure, as well as to treat individual project risks. The key benefit of this process is that it identifies appropriate ways to address overall project risk and individual project risks. This process also allocates resources and inserts activities into project documents and the project management plan as needed. This process is performed throughout the project. The inputs, tools and techniques, and outputs of the process are depicted in Figure 11-16. Figure 11-17 depicts the data flow diagram for the process.

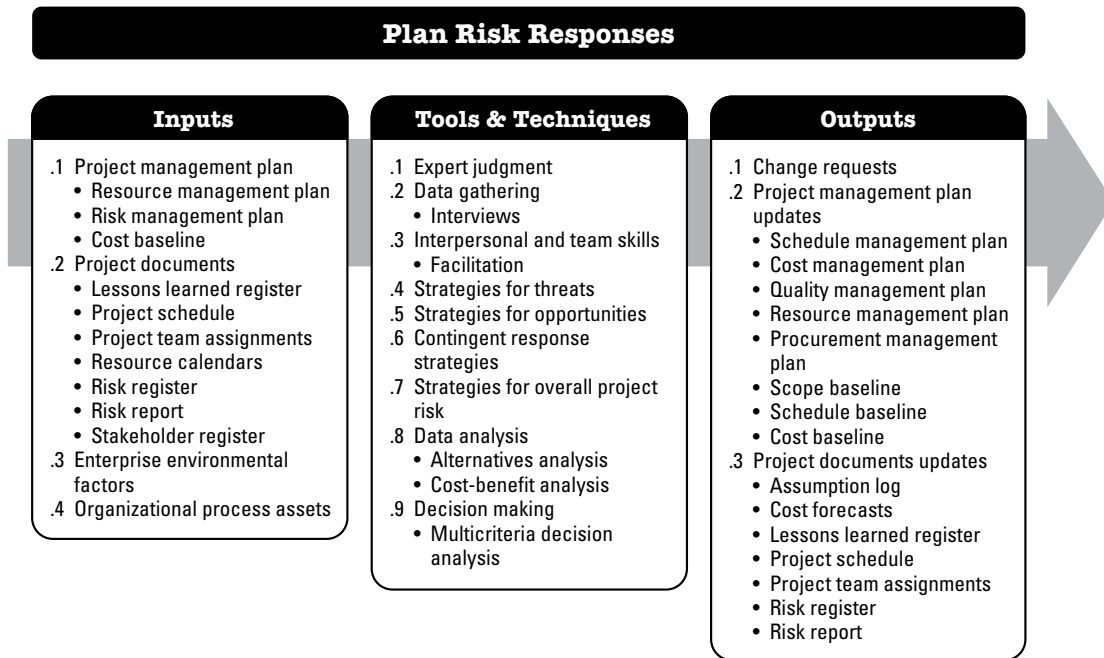

Figure 11-16. Plan Risk Responses: Inputs, Tools & Techniques, and Outputs

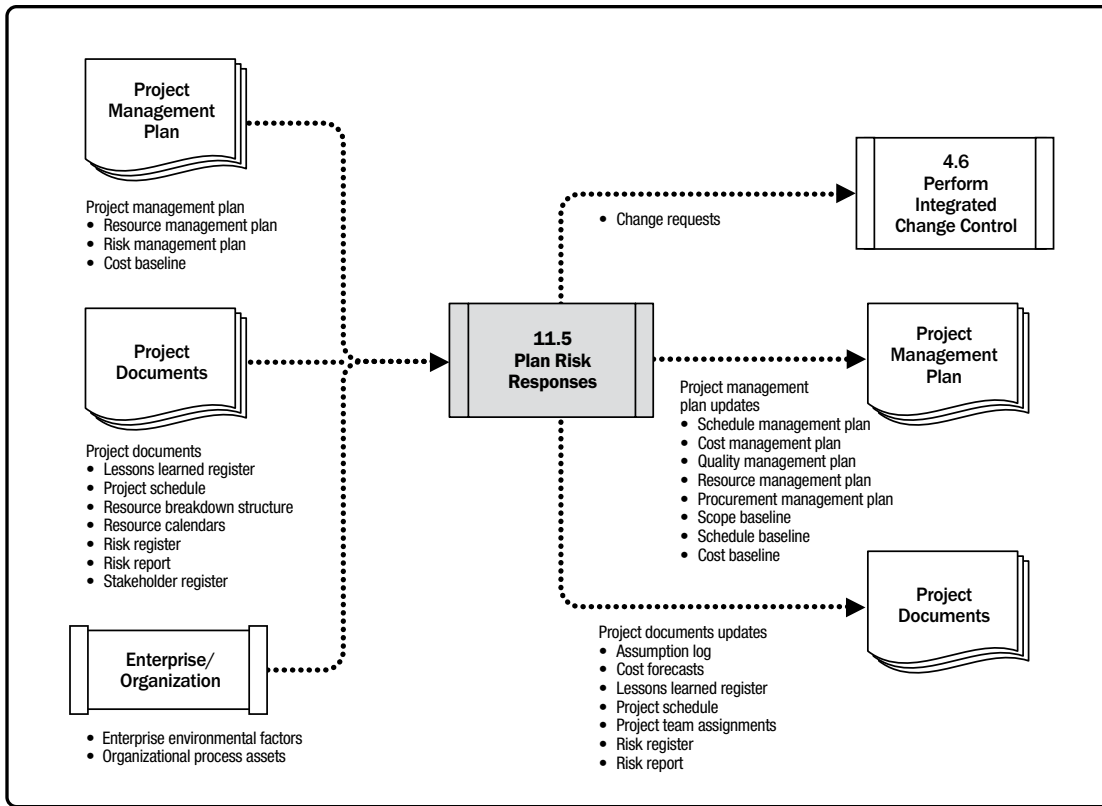

Figure 11-17. Plan Risk Responses: Data Flow Diagram

Effective and appropriate risk responses can minimize individual threats, maximize individual opportunities, and reduce overall project risk exposure. Unsuitable risk responses can have the converse effect. Once risks have been identified, analyzed, and prioritized, plans should be developed by the nominated risk owner for addressing every individual project risk the project team considers to be sufficiently important, either because of the threat it poses to the project objectives or the opportunity it offers. The project manager should also consider how to respond appropriately to the current level of overall project risk.

Risk responses should be appropriate for the significance of the risk, cost-effective in meeting the challenge, realistic within the project context, agreed upon by all parties involved, and owned by a responsible person. Selecting the optimal risk response from several options is often required. The strategy or mix of strategies most likely to be effective should be selected for each risk. Structured decision-making techniques may be used to choose the most appropriate response. For large or complex projects, it may be appropriate to use a mathematical optimization model or real options analysis as a basis for a more robust economic analysis of alternative risk response strategies.

Specific actions are developed to implement the agreed-upon risk response strategy, including primary and backup strategies, as necessary. A contingency plan (or fallback plan) can be developed for implementation if the selected strategy turns out not to be fully effective or if an accepted risk occurs. Secondary risks should also be identified. Secondary risks are risks that arise as a direct result of implementing a risk response. A contingency reserve is often allocated for time or cost. If developed, it may include identification of the conditions that trigger its use.

11.5.1 PLAN RISK RESPONSES: INPUTS

11.5.1.1 PROJECT MANAGEMENT PLAN

Described in Section 4.2.3.1. Project management plan components include but are not limited to:

- ◆ **Resource management plan.** Described in Section 9.1.3.1. The resource management plan is used to help determine how resources allocated to agreed-upon risk responses will be coordinated with other project resources.
- ◆ **Risk management plan.** Described in Section 11.1.3.1. Risk management roles and responsibilities and risk thresholds are used in this process.
- ◆ **Cost baseline.** Described in Section 7.3.3.1. The cost baseline has information on the contingency fund that is allocated to respond to risks.

11.5.1.2 PROJECT DOCUMENTS

Project documents that can be considered as inputs for this process include but are not limited to:

- ◆ **Lessons learned register.** Described in Section 4.4.3.1. Lessons learned about effective risk responses used in earlier phases of the project are reviewed to determine if similar responses might be useful during the remainder of the project.
- ◆ **Project schedule.** Described in Section 6.5.3.2. The schedule is used to determine how agreed-upon risk responses will be scheduled alongside other project activities.
- ◆ **Project team assignments.** Described in Section 9.3.3.2. Project team assignments can show the resources that can be allocated to agreed-upon risk responses.
- ◆ **Resource calendars.** Described in Section 9.2.1.2. Resource calendars identify when potential resources are available to be allocated to agreed-upon risk responses.
- ◆ **Risk register.** Described in Section 11.2.3.1. The risk register contains details of individual project risks that have been identified and prioritized, and for which risk responses are required. The priority level for each risk can help to guide the selection of appropriate risk responses. For example, high-priority threats or opportunities may require priority action and highly proactive response strategies. Threats and opportunities in the low-priority zone may not require proactive management action beyond being placed in the risk register as part of the watch list or adding a contingency reserve.

The risk register identifies the nominated risk owner for each risk. It may also contain preliminary risk responses identified earlier in the Project Risk Management process. The risk register may provide other data on identified risks that can assist in planning risk responses, including root causes, risk triggers and warning signs, risks requiring responses in the near term, and risks where a need for additional analysis has been identified.

- ◆ **Risk report.** Described in Section 11.2.3.2. The risk report presents the current level of overall risk exposure of the project that will inform selection of the risk response strategy. The risk report may also list individual project risks in priority order and provide additional analysis of the distribution of individual project risks that may inform risk response selection.
- ◆ **Stakeholder register.** Described in Section 13.1.3.1. The stakeholder register identifies potential owners for risk responses.

11.5.1.3 ENTERPRISE ENVIRONMENTAL FACTORS

The enterprise environmental factors that can influence the Plan Risk Responses process include but are not limited to the risk appetite and thresholds of key stakeholders.

11.5.1.4 ORGANIZATIONAL PROCESS ASSETS

The organizational process assets that can influence the Plan Risk Responses process include but are not limited to:

- ◆ Templates for the risk management plan, risk register, and risk report;
- ◆ Historical databases; and
- ◆ Lessons learned repositories from similar projects.

11.5.2 PLAN RISK RESPONSES: TOOLS AND TECHNIQUES

11.5.2.1 EXPERT JUDGMENT

Described in Section 4.1.2.1. Expertise should be considered from individuals or groups with specialized knowledge in the following topics:

- ◆ Threat response strategies,
- ◆ Opportunity response strategies,
- ◆ Contingent response strategies, and
- ◆ Overall project risk response strategies.

Expert input may be sought from individuals with particular subject matter expertise relevant to a specific individual project risk, for example, where specialist technical knowledge is required.

11.5.2.2 DATA GATHERING

Data-gathering techniques that can be used for this process include but are not limited to interviews (see Section 5.2.2.2). Development of responses to individual project risks and overall project risk may be undertaken during structured or semi-structured interviews (see Section 5.2.2.2) with risk owners. Other stakeholders may also be interviewed if necessary. The interviewer should promote an environment of trust and confidentiality in the interview setting to encourage honest and unbiased decisions.

11.5.2.3 INTERPERSONAL AND TEAM SKILLS

Interpersonal and team skills that can be used for this process includes but are not limited to facilitation (see Section 4.1.2.3). The use of facilitation improves the effectiveness of developing responses to individual project risks and overall project risk. A skilled facilitator can help risk owners understand the risk, identify and compare alternative possible risk response strategies, choose an appropriate response strategy, and identify and overcome sources of bias.

11.5.2.4 STRATEGIES FOR THREATS

Five alternative strategies may be considered for dealing with threats, as follows:

- ◆ **Escalate.** Escalation is appropriate when the project team or the project sponsor agrees that a threat is outside the scope of the project or that the proposed response would exceed the project manager's authority. Escalated risks are managed at the program level, portfolio level, or other relevant part of the organization, and not on the project level. The project manager determines who should be notified about the threat and communicates the details to that person or part of the organization. It is important that ownership of escalated threats is accepted by the relevant party in the organization. Threats are usually escalated to the level that matches the objectives that would be affected if the threat occurred. Escalated threats are not monitored further by the project team after escalation, although they may be recorded in the risk register for information.

- ◆ **Avoid.** Risk avoidance is when the project team acts to eliminate the threat or protect the project from its impact. It may be appropriate for high-priority threats with a high probability of occurrence and a large negative impact. Avoidance may involve changing some aspect of the project management plan or changing the objective that is in jeopardy in order to eliminate the threat entirely, reducing its probability of occurrence to zero. The risk owner may also take action to isolate the project objectives from the risk's impact if it were to occur. Examples of avoidance actions may include removing the cause of a threat, extending the schedule, changing the project strategy, or reducing scope. Some risks can be avoided by clarifying requirements, obtaining information, improving communication, or acquiring expertise.
- ◆ **Transfer.** Transfer involves shifting ownership of a threat to a third party to manage the risk and to bear the impact if the threat occurs. Risk transfer often involves payment of a risk premium to the party taking on the threat. Transfer can be achieved by a range of actions, which include but are not limited to the use of insurance, performance bonds, warranties, guarantees, etc. Agreements may be used to transfer ownership and liability for specified risks to another party.
- ◆ **Mitigate.** In risk mitigation, action is taken to reduce the probability of occurrence and/or impact of a threat. Early mitigation action is often more effective than trying to repair the damage after the threat has occurred. Adopting less complex processes, conducting more tests, or choosing a more stable seller are examples of mitigation actions. Mitigation may involve prototype development (see Section 5.2.2.8) to reduce the risk of scaling up from a bench-scale model of a process or product. Where it is not possible to reduce probability, a mitigation response might reduce the impact by targeting factors that drive the severity. For example, designing redundancy into a system may reduce the impact from a failure of the original component.
- ◆ **Accept.** Risk acceptance acknowledges the existence of a threat, but no proactive action is taken. This strategy may be appropriate for low-priority threats, and it may also be adopted where it is not possible or cost-effective to address a threat in any other way. Acceptance can be either active or passive. The most common active acceptance strategy is to establish a contingency reserve, including amounts of time, money, or resources to handle the threat if it occurs. Passive acceptance involves no proactive action apart from periodic review of the threat to ensure that it does not change significantly.

11.5.2.5 STRATEGIES FOR OPPORTUNITIES

Five alternative strategies may be considered for dealing with opportunities, as follows:

- ◆ **Escalate.** This risk response strategy is appropriate when the project team or the project sponsor agrees that an opportunity is outside the scope of the project or that the proposed response would exceed the project manager's authority. Escalated opportunities are managed at the program level, portfolio level, or other relevant part of the organization, and not on the project level. The project manager determines who should be notified about the opportunity and communicates the details to that person or part of the organization. It is important that ownership of escalated opportunities is accepted by the relevant party in the organization. Opportunities are usually escalated to the level that matches the objectives that would be affected if the opportunity occurred. Escalated opportunities are not monitored further by the project team after escalation, although they may be recorded in the risk register for information.
- ◆ **Exploit.** The exploit strategy may be selected for high-priority opportunities where the organization wants to ensure that the opportunity is realized. This strategy seeks to capture the benefit associated with a particular opportunity by ensuring that it definitely happens, increasing the probability of occurrence to 100%. Examples of exploiting responses may include assigning an organization's most talented resources to the project to reduce the time to completion, or using new technologies or technology upgrades to reduce cost and duration.
- ◆ **Share.** Sharing involves transferring ownership of an opportunity to a third party so that it shares some of the benefit if the opportunity occurs. It is important to select the new owner of a shared opportunity carefully so they are best able to capture the opportunity for the benefit of the project. Risk sharing often involves payment of a risk premium to the party taking on the opportunity. Examples of sharing actions include forming risk-sharing partnerships, teams, special-purpose companies, or joint ventures.
- ◆ **Enhance.** The enhance strategy is used to increase the probability and/or impact of an opportunity. Early enhancement action is often more effective than trying to improve the benefit after the opportunity has occurred. The probability of occurrence of an opportunity may be increased by focusing attention on its causes. Where it is not possible to increase probability, an enhancement response might increase the impact by targeting factors that drive the size of the potential benefit. Examples of enhancing opportunities include adding more resources to an activity to finish early.
- ◆ **Accept.** Accepting an opportunity acknowledges its existence but no proactive action is taken. This strategy may be appropriate for low-priority opportunities, and it may also be adopted where it is not possible or cost-effective to address an opportunity in any other way. Acceptance can be either active or passive. The most common active acceptance strategy is to establish a contingency reserve, including amounts of time, money, or resources to take advantage of the opportunity if it occurs. Passive acceptance involves no proactive action apart from periodic review of the opportunity to ensure that it does not change significantly.

11.5.2.6 CONTINGENT RESPONSE STRATEGIES

Some responses are designed for use only if certain events occur. For some risks, it is appropriate for the project team to make a response plan that will only be executed under certain predefined conditions, if it is believed that there will be sufficient warning to implement the plan. Events that trigger the contingency response, such as missing intermediate milestones or gaining higher priority with a seller, should be defined and tracked. Risk responses identified using this technique are often called contingency plans or fallback plans and include identified triggering events that set the plans in effect.

11.5.2.7 STRATEGIES FOR OVERALL PROJECT RISK

Risk responses should be planned and implemented not only for individual project risks but also to address overall project risk. The same risk response strategies that are used to deal with individual project risks can also be applied to overall project risk:

- ◆ **Avoid.** Where the level of overall project risk is significantly negative and outside the agreed-upon risk thresholds for the project, an avoid strategy may be adopted. This involves taking focused action to reduce the negative effect of uncertainty on the project as a whole and bring the project back within the thresholds. An example of avoidance at the overall project level would include removal of high-risk elements of scope from the project. Where it is not possible to bring the project back within the thresholds, the project may be canceled. This represents the most extreme degree of risk avoidance and it should be used only if the overall level of threat is, and will remain, unacceptable.
- ◆ **Exploit.** Where the level of overall project risk is significantly positive and outside the agreed-upon risk thresholds for the project, an exploit strategy may be adopted. This involves taking focused action to capture the positive effect of uncertainty on the project as a whole. An example of exploiting at the overall project level would include addition of high-benefit elements of scope to the project to add value or benefits to stakeholders. Alternatively the risk thresholds for the project may be modified with the agreement of key stakeholders in order to embrace the opportunity.
- ◆ **Transfer/share.** If the level of overall project risk is high but the organization is unable to address it effectively, a third party may be involved to manage the risk on behalf of the organization. Where overall project risk is negative, a transfer strategy is required, which may involve payment of a risk premium. In the case of high positive overall project risk, ownership may be shared in order to reap the associated benefits. Examples of both transfer and share strategies for overall project risk include but are not limited to setting up a collaborative business structure in which the buyer and the seller share the overall project risk, launching a joint venture or special-purpose company, or subcontracting key elements of the project.

- ◆ **Mitigate/enhance.** These strategies involve changing the level of overall project risk to optimize the chances of achieving the project's objectives. The mitigation strategy is used where overall project risk is negative, and enhancement applies when it is positive. Examples of mitigation or enhancement strategies include replanning the project, changing the scope and boundaries of the project, modifying project priority, changing resource allocations, adjusting delivery times, etc.
- ◆ **Accept.** Where no proactive risk response strategy is possible to address overall project risk, the organization may choose to continue with the project as currently defined, even if overall project risk is outside the agreed-upon thresholds. Acceptance can be either active or passive. The most common active acceptance strategy is to establish an overall contingency reserve for the project, including amounts of time, money, or resources to be used if the project exceeds its thresholds. Passive acceptance involves no proactive action apart from periodic review of the level of overall project risk to ensure that it does not change significantly.

11.5.2.8 DATA ANALYSIS

A number of alternative risk response strategies may be considered. Data analysis techniques that can be used to select a preferred risk response strategy include but are not limited to:

- ◆ **Alternatives analysis.** A simple comparison of the characteristics and requirements of alternative risk response options can lead to a decision on which response is most appropriate.
- ◆ **Cost-benefit analysis.** If the impact of an individual project risk can be quantified in monetary terms, then the cost-effectiveness of alternative risk response strategies can be determined using cost-benefit analysis (see Section 8.1.2.3). The ratio of (change in impact level) divided by (implementation cost) gives the cost effectiveness of the response strategy, with a higher ratio indicating a more effective response.

11.5.2.9 DECISION MAKING

Decision-making techniques that can be used to select a risk response strategy include but are not limited to multicriteria decision analysis (described in Section 8.1.2.4). One or more risk response strategies may be under consideration. Decision-making techniques can help prioritize risk response strategies. Multicriteria decision analysis uses a decision matrix to provide a systematic approach for establishing key decision criteria, evaluating and ranking alternatives, and selecting a preferred option. Criteria for risk response selection may include but are not limited to cost of response, likely effectiveness of response in changing probability and/or impact, resource availability, timing constraints (urgency, proximity, and dormancy), level of impact if the risk occurs, effect of response on related risks, introduction of secondary risks, etc. Different strategies may be selected later in the project if the original choice proves to be ineffective.

11.5.3 PLAN RISK RESPONSES: OUTPUTS

11.5.3.1 CHANGE REQUESTS

Described in Section 4.3.3.4. Planned risk responses may result in a change request to the cost and schedule baselines or other components of the project management plan. Change requests are processed for review and disposition through the Perform Integrated Change Control process (Section 4.6).

11.5.3.2 PROJECT MANAGEMENT PLAN UPDATES

Any change to the project management plan goes through the organization's change control process via a change request. Components that may require a change request for the project management plan include but are not limited to:

- ◆ **Schedule management plan.** Described in Section 6.1.3.1. Changes to the schedule management plan, such as changes to resource loading and leveling, or updates to the schedule strategy, are incorporated.
- ◆ **Cost management plan.** Described in Section 7.1.3.1. Changes to the cost management plan, such as changes to cost accounting, tracking, and reports, as well as updates to the budget strategy and how contingency reserves are consumed, are incorporated.
- ◆ **Quality management plan.** Described in Section 8.1.3.1. Changes to the quality management plan, such as changes to approaches for meeting requirements, quality management approaches, or quality control processes, are incorporated.
- ◆ **Resource management plan.** Described in Section 9.1.3.1. Changes to the resource management plan, such as changes to resource allocation, as well as updates to the resource strategy, are incorporated.
- ◆ **Procurement management plan.** Described in Section 12.1.3.1. Changes to the procurement management plan, such as alterations in the make-or-buy decision or contract type(s), are incorporated.
- ◆ **Scope baseline.** Described in Section 5.4.3.1. Changes in the scope baseline are incorporated in response to approved changes in scope that may arise from agreed-upon risk responses.
- ◆ **Schedule baseline.** Described in Section 6.5.3.1. Changes in the schedule baseline are incorporated in response to approved changes in schedule estimates that may arise from agreed-upon risk responses.
- ◆ **Cost baseline.** Described in Section 7.3.3.1. Changes in the cost baseline are incorporated in response to approved changes in cost estimates that may arise from agreed-upon risk responses.

11.5.3.3 PROJECT DOCUMENTS UPDATES

Project documents that may be updated as a result of carrying out this process include but are not limited to:

- ◆ **Assumption log.** Described in Section 4.1.3.2. During the Plan Risk Responses process, new assumptions may be made, new constraints may be identified, and existing assumptions or constraints may be revisited and changed. The assumption log should be updated with this new information.
- ◆ **Cost forecasts.** Described in Section 7.4.3.2. Cost forecasts may change as a result of planned risk responses.
- ◆ **Lessons learned register.** Described in Section 4.4.3.1. The lessons learned register is updated with information about risk responses that may be useful for future phases of the project or future projects.
- ◆ **Project schedule.** Described in Section 6.5.3.2. Activities relating to agreed-upon risk responses may be added to the project schedule.
- ◆ **Project team assignments.** Described in Section 9.3.3.2. Once the responses are confirmed, the necessary resources should be allocated to each action associated with a risk response plan. These resources include suitably qualified and experienced personnel to execute the agreed-upon action (usually within the project team) a specific budget and time allowance for the action, and any required technical resources to complete the action.
- ◆ **Risk register.** Described in Section 11.2.3.1. The risk register is updated when appropriate risk responses are chosen and agreed upon. Updates to the risk register may include but are not limited to:
 - Agreed-upon response strategies;
 - Specific actions to implement the chosen response strategy;
 - Trigger conditions, symptoms, and warning signs of a risk occurrence;
 - Budget and schedule activities required to implement the chosen responses;
 - Contingency plans and risk triggers that call for their execution;
 - Fallback plans for use when a risk that has occurred and the primary response proves to be inadequate;
 - Residual risks that are expected to remain after planned responses have been taken, as well as those that have been deliberately accepted; and
 - Secondary risks that arise as a direct outcome of implementing a risk response.
- ◆ **Risk report.** Described in Section 11.2.3.2. The risk report may be updated to present agreed-upon responses to the current overall project risk exposure and high-priority risks, together with the expected changes that may be expected as a result of implementing these responses.

11.6 IMPLEMENT RISK RESPONSES

Implement Risk Responses is the process of implementing agreed-upon risk response plans. The key benefit of this process is that it ensures that agreed-upon risk responses are executed as planned in order to address overall project risk exposure, minimize individual project threats, and maximize individual project opportunities. This process is performed throughout the project. The inputs, tools and techniques, and outputs of the process are depicted in Figure 11-18. Figure 11-19 depicts the data flow diagram for the process.

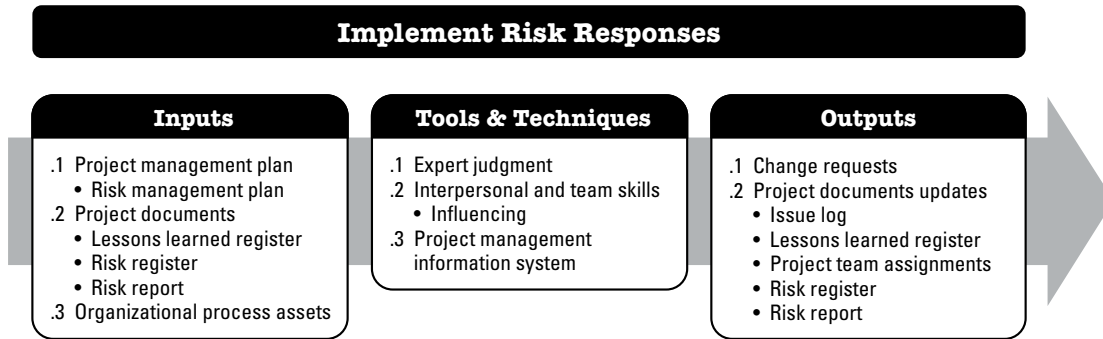

Figure 11-18. Implement Risk Responses: Inputs, Tools & Techniques, and Outputs

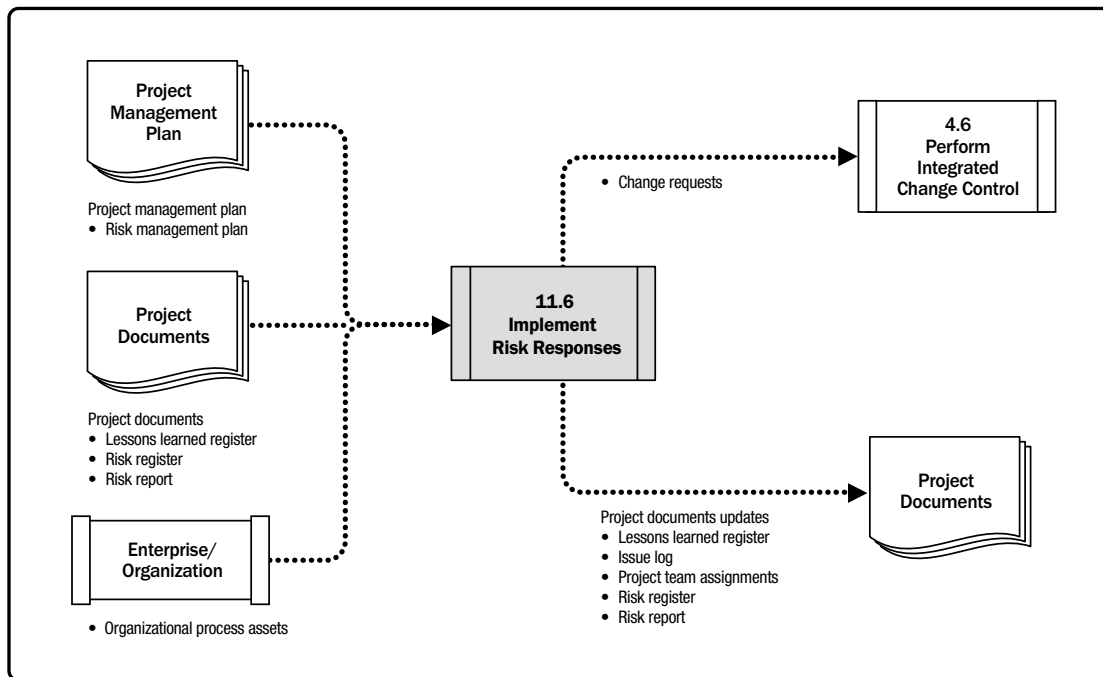

Figure 11-19. Implement Risk Responses: Data Flow Diagram

Proper attention to the Implement Risk Responses process will ensure that agreed-upon risk responses are actually executed. A common problem with Project Risk Management is that project teams spend effort in identifying and analyzing risks and developing risk responses, then risk responses are agreed upon and documented in the risk register and risk report, but no action is taken to manage the risk.

Only if risk owners give the required level of effort to implementing the agreed-upon responses will the overall risk exposure of the project and individual threats and opportunities be managed proactively.

11.6.1 IMPLEMENT RISK RESPONSES: INPUTS

11.6.1.1 PROJECT MANAGEMENT PLAN

Described in Section 4.2.3.1. Project management plan components include but are not limited to the risk management plan. Described in Section 11.1.3.1, the risk management plan lists the roles and responsibilities of project team members and other stakeholders for risk management. This information is used when allocating owners for agreed-upon risk responses. The risk management plan also defines the level of detail for the risk management methodology for the project. It also specifies risk thresholds for the project based on the risk appetite of key stakeholders, which define the acceptable target that the implementation of risk responses is required to achieve.

11.6.1.2 PROJECT DOCUMENTS

Project documents that can be considered as inputs for this process include but are not limited to:

- ◆ **Lessons learned register.** Described in Section 4.4.3.1. Lessons learned earlier in the project with regard to implementing risk responses can be applied to later phases in the project to improve the effectiveness of this process.
- ◆ **Risk register.** Described in Section 11.2.3.1. The risk register records the agreed-upon risk responses for each individual risk and the nominated owners for each response plan.
- ◆ **Risk report.** Described in Section 11.2.3.2. The risk report includes an assessment of the current overall project risk exposure, as well as the agreed-upon risk response strategy. It also describes the major individual project risks with their planned responses.

11.6.1.3 ORGANIZATIONAL PROCESS ASSETS

The organizational process assets that can influence the Implement Risk Responses process include but are not limited to the lessons learned repository from similar completed projects that indicate the effectiveness of particular risk responses.

11.6.2 IMPLEMENT RISK RESPONSES: TOOLS AND TECHNIQUES

11.6.2.1 EXPERT JUDGMENT

Described in Section 4.1.2.1. Expertise should be considered from individuals or groups with specialized knowledge to validate or modify risk responses if necessary, and decide how to implement them in the most efficient and effective manner.

11.6.2.2 INTERPERSONAL AND TEAM SKILLS

Interpersonal and team skills that can be used for this process include but are not limited to influencing. Some risk response actions may be owned by people outside the immediate project team or who have other competing demands. The project manager or person responsible for facilitating the risk process may need to exercise influencing (see Section 9.5.2.1) to encourage nominated risk owners to take necessary action where required.

11.6.2.3 PROJECT MANAGEMENT INFORMATION SYSTEM (PMIS)

Described in Section 4.3.2.2. Project management information systems can include schedule, resource, and cost software to ensure that agreed-upon risk response plans and their associated activities are integrated into the project alongside other project activities.

11.6.3 IMPLEMENT RISK RESPONSES: OUTPUTS

11.6.3.1 CHANGE REQUESTS

Described in Section 4.3.3.4. Implementation of risk responses may result in a change request to the cost and schedule baselines or other components of the project management plan. Change requests are processed for review and disposition through the Perform Integrated Change Control process (Section 4.6).



11.6.3.2 PROJECT DOCUMENTS UPDATES

Project documents that may be updated as a result of carrying out this process include but are not limited to:

- ◆ **Issue log.** Described in Section 4.3.3.3. Where issues are identified as part of the Implement Risk Responses process, they are recorded in the issue log.
- ◆ **Lessons learned register.** Described in Section 4.4.3.1. The lessons learned register is updated with information on challenges encountered when implementing risk responses and how they could have been avoided, as well as approaches that worked well for implementing risk responses.
- ◆ **Project team assignments.** Described in Section 9.3.3.2. Once the risk responses are confirmed, the necessary resources should be allocated to each action associated with a risk response plan. These resources include suitably qualified and experienced personnel to execute the agreed-upon action (usually within the project team), a specific budget and time allowance for the action, and any required technical resources to complete the action.
- ◆ **Risk register.** Described in Section 11.2.3.1. The risk register may be updated to reflect any changes to the previously agreed-upon risk responses for individual project risks that are subsequently made as a result of the Implement Risk Responses process.
- ◆ **Risk report.** Described in Section 11.2.3.2. The risk report may be updated to reflect any changes to the previously agreed-upon risk response to overall project risk exposure that are subsequently made as a result of the Implement Risk Responses process.

11.7 MONITOR RISKS

Monitor Risks is the process of monitoring the implementation of agreed-upon risk response plans, tracking identified risks, identifying and analyzing new risks, and evaluating risk process effectiveness throughout the project. The key benefit of this process is that it enables project decisions to be based on current information about overall project risk exposure and individual project risks. This process is performed throughout the project. The inputs, tools and techniques, and outputs of the process are depicted in Figure 11-20. Figure 11-21 depicts the data flow diagram for the process.

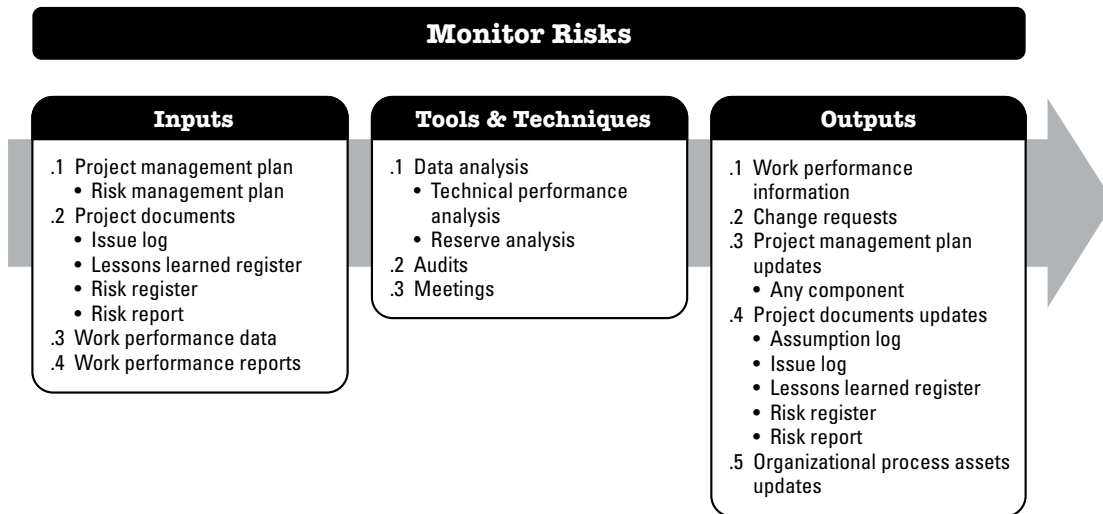

Figure 11-20. Monitor Risks: Inputs, Tools & Techniques, and Outputs

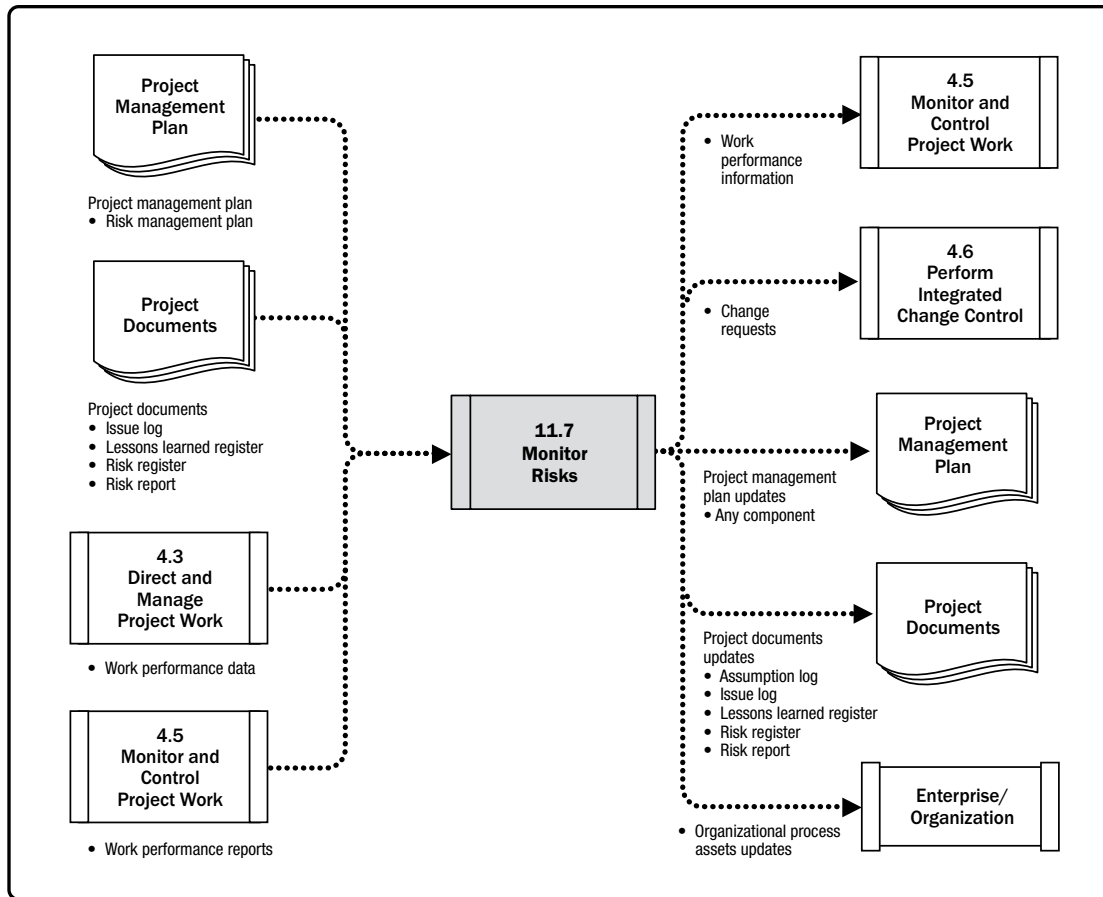

Figure 11-21. Monitor Risks: Data Flow Diagram

In order to ensure that the project team and key stakeholders are aware of the current level of risk exposure, project work should be continuously monitored for new, changing, and outdated individual project risks and for changes in the level of overall project risk by applying the Monitor Risks process. The Monitor Risks process uses performance information generated during project execution to determine if:

- ◆ Implemented risk responses are effective,
- ◆ Level of overall project risk has changed,
- ◆ Status of identified individual project risks has changed,
- ◆ New individual project risks have arisen,
- ◆ Risk management approach is still appropriate,
- ◆ Project assumptions are still valid,
- ◆ Risk management policies and procedures are being followed,
- ◆ Contingency reserves for cost or schedule require modification, and
- ◆ Project strategy is still valid.

11.7.1 MONITOR RISKS: INPUTS

11.7.1.1 PROJECT MANAGEMENT PLAN

Described in Section 4.2.3.1. Project management plan components include but are not limited to the risk management plan. Described in Section 11.3.1.1. The risk management plan provides guidance on how and when risks should be reviewed, which policies and procedures should be followed, the roles and responsibilities in the monitoring process, and reporting formats.

11.7.1.2 PROJECT DOCUMENTS

Project documents that should be considered as inputs for this process include but are not limited to:

- ◆ **Issue log.** Described in Section 4.3.3.3. The issue log is used to see if any of the open issues have been updated and necessitate an update to the risk register.
- ◆ **Lessons learned register.** Described in Section 4.4.3.1. Risk-related lessons from earlier in the project can be applied to later phases in the project.
- ◆ **Risk register.** Described in Section 11.2.3.1. The risk register has key inputs that include identified individual project risks, risk owners, agreed-upon risk responses, and specific implementation actions. It may also provide other details including control actions for assessing the effectiveness of response plans, symptoms and warning signs of risk, residual and secondary risks, and a watch list of low-priority risks.
- ◆ **Risk report.** Described in Section 11.2.3.2. The risk report includes an assessment of the current overall project risk exposure as well as the agreed-upon risk response strategy. It also describes the major individual risks with planned responses and risk owners.



11.7.1.3 WORK PERFORMANCE DATA

Described in Section 4.3.3.2. Work performance data contains data on project status such as risk responses that have been implemented, risks that have occurred, risks that are active and those that have been closed out.

11.7.1.4 WORK PERFORMANCE REPORTS

Described in Section 4.5.3.1. Work performance reports provide information from performance measurements that can be analyzed to provide project work performance information including variance analysis, earned value data, and forecasting data. This information could be relevant when monitoring performance-related risks.

11.7.2 MONITOR RISKS: TOOLS AND TECHNIQUES

11.7.2.1 DATA ANALYSIS

Data analysis techniques that can be used for this process include but are not limited to:

- ◆ **Technical performance analysis.** Technical performance analysis compares technical accomplishments during project execution to the schedule of technical achievement. It requires the definition of objective, quantifiable measures of technical performance, which can be used to compare actual results against targets. Such technical performance measures may include weight, transaction times, number of delivered defects, storage capacity, etc. Deviation can indicate the potential impact of threats or opportunities.
- ◆ **Reserve analysis.** Described in Section 7.2.2.6. Throughout execution of the project, some individual project risks may occur with positive or negative impacts on budget or schedule contingency reserves. Reserve analysis compares the amount of the contingency reserves remaining to the amount of risk remaining at any time in the project in order to determine if the remaining reserve is adequate. This may be communicated using various graphical representations, including a burndown chart.

11.7.2.2 AUDITS

Described in Section 8.2.2.5. Risk audits are a type of audit that may be used to consider the effectiveness of the risk management process. The project manager is responsible for ensuring that risk audits are performed at an appropriate frequency, as defined in the project's risk management plan. Risk audits may be included during routine project review meetings or may form part of a risk review meeting, or the team may choose to hold separate risk audit meetings. The format for the risk audit and its objectives should be clearly defined before the audit is conducted.

11.7.2.3 MEETINGS

Meetings that can be used during this process include but are not limited to risk reviews. Risk reviews are scheduled regularly and should examine and document the effectiveness of risk responses in dealing with overall project risk and with identified individual project risks. Risk reviews may also result in identification of new individual project risks, (including secondary risks that arise from agreed-upon risk responses), reassessment of current risks, the closing of risks that are outdated, issues that have arisen as the result of risks that have occurred, and identification of lessons to be learned for implementation in ongoing phases in the current project or in similar projects in the future. The risk review may be conducted as part of a periodic project status meeting or a dedicated risk review meeting may be held, as specified in the risk management plan.

11.7.3 MONITOR RISKS: OUTPUTS

11.7.3.1 WORK PERFORMANCE INFORMATION

Described in Section 4.5.1.3. Work performance information includes information on how project risk management is performing by comparing the individual risks that have occurred with the expectation of how they would occur. This information indicates the effectiveness of the response planning and response implementation processes.

11.7.3.2 CHANGE REQUESTS

Described in Section 4.3.3.4. The Monitor Risks process may result in a change request to the cost and schedule baselines or other components of the project management plan. Change requests are processed for review and disposition through the Perform Integrated Change Control process (Section 4.6).

Change requests can include recommended corrective and preventive actions to address the current level of overall project risk or to address individual project risks.

11.7.3.3 PROJECT MANAGEMENT PLAN UPDATES

Any change to the project management plan goes through the organization's change control process via a change request. This may affect any component of the project management plan.

11.7.3.4 PROJECT DOCUMENTS UPDATES

Project documents that may be updated as a result of carrying out this process include but are not limited to:

- ◆ **Assumption log.** Described in Section 4.1.3.2. During the Monitor Risks process, new assumptions may be made, new constraints may be identified, and existing assumptions or constraints may be revisited and changed. The assumption log is updated with this new information.
- ◆ **Issue log.** Described in Section 4.3.3.3. Where issues are identified as part of the Monitor Risks process, these are recorded in the issue log.
- ◆ **Lessons learned register.** Described in Section 4.4.3.1. The lessons learned register is updated with any risk-related lessons learned during risk reviews so these can be used on later phases of the project or in future projects.
- ◆ **Risk register.** Described in Section 11.2.3.1. The risk register is updated with information on individual project risks generated during the Monitor Risks process. This may include adding new risks, updating outdated risks or risks that were realized, updating risk responses, and so forth.
- ◆ **Risk report.** Described in Section 11.2.3.2. As new information becomes available through the Monitor Risks process, the risk report is updated to reflect the current status of major individual project risks and the current level of overall project risk. The risk report may also include details of the top individual project risks, agreed-upon responses and owners, and conclusions and recommendations. It may also include conclusions from risk audits on the effectiveness of the risk management process.

11.7.3.5 ORGANIZATIONAL PROCESS ASSETS UPDATES

Organizational process assets that are updated as a result of the Monitor Risks process include but are not limited to:

- ◆ Templates for the risk management plan, risk register, and risk report; and
- ◆ Risk breakdown structure.

12

PROJECT PROCUREMENT MANAGEMENT

Project Procurement Management includes the processes necessary to purchase or acquire products, services, or results needed from outside the project team. Project Procurement Management includes the management and control processes required to develop and administer agreements such as contracts, purchase orders, memoranda of agreements (MOAs), or internal service level agreements (SLAs). The personnel authorized to procure the goods and/or services required for the project may be members of the project team, management, or part of the organization's purchasing department if applicable.

Project Procurement Management processes include the following:

12.1 Plan Procurement Management—The process of documenting project procurement decisions, specifying the approach, and identifying potential sellers.

12.2 Conduct Procurements—The process of obtaining seller responses, selecting a seller, and awarding a contract.

12.3 Control Procurements—The process of managing procurement relationships, monitoring contract performance, making changes and corrections as appropriate, and closing out contracts.

The procurement processes are presented as discrete processes with defined interfaces. In practice, procurement processes can be complex and can interact with each other and with processes in other Knowledge Areas in ways that cannot be completely detailed in the *PMBOK® Guide*. The processes described in this section are written from the viewpoint where goods or services are obtained from outside of the project.

Figure 12-1 provides an overview of the Project Procurement Management processes. The Project Procurement Management processes are presented as discrete processes with defined interfaces while, in practice, they overlap and interact in ways that cannot be completely detailed in the *PMBOK® Guide*.

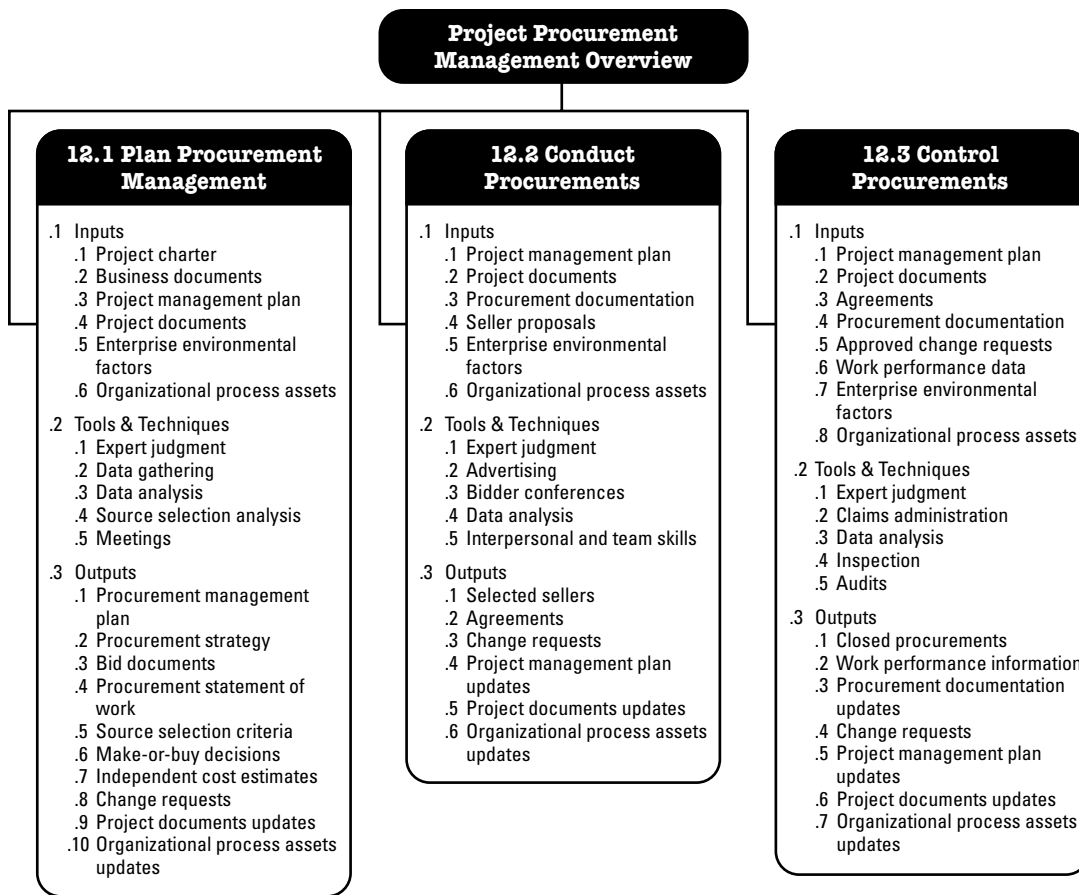

Figure 12-1 Project Procurement Management Overview

KEY CONCEPTS FOR PROJECT PROCUREMENT MANAGEMENT

More than most other project management processes, there can be significant legal obligations and penalties tied to the procurement process. The project manager does not have to be a trained expert in procurement management laws and regulations but should be familiar enough with the procurement process to make intelligent decisions regarding contracts and contractual relationships. The project manager is typically not authorized to sign legal agreements binding the organization; this is reserved for those who have the authority to do so.

The Project Procurement Management processes involve agreements that describe the relationship between two parties—a buyer and a seller. Agreements can be as simple as the purchase of a defined quantity of labor hours at a specified labor rate, or they can be as complex as multiyear international construction contracts. The contracting approach and the contract itself should reflect the simplicity or complexity of the deliverables or required effort and should be written in a manner that complies with local, national, and international laws regarding contracts.

A contract should clearly state the deliverables and results expected, including any knowledge transfer from the seller to the buyer. Anything not in the contract cannot be legally enforced. When working internationally, project managers should keep in mind the effect that culture and local law have upon contracts and their enforceability, no matter how clearly a contract is written.

A purchasing contract includes terms and conditions and may incorporate other buyer specifics as to what the seller is to perform or provide. It is the project management team's responsibility to make certain that all procurements meet the specific needs of the project while working with the procurement office to ensure organizational procurement policies are followed. Depending on the application area, an agreement can be a contract, an SLA, an understanding, an MOA, or a purchase order.

Most organizations document policies and procedures specifically defining procurement rules and specifying who has authority to sign and administer such agreements on behalf of the organization. Across the world, organizations use different names for departments or divisions that deal with procurement, such as purchasing, contracting, procurement, or acquisitions; however, the responsibilities are likely to be similar.

Although all project documents may be subject to some form of review and approval, the legally binding nature of a contract means it will be subjected to a more extensive approval process, often involving the legal department. In all cases, the primary focus of the review and approval process is to ensure that the contract adequately describes the products, services, or results that the seller is agreeing to provide, while being in compliance with the laws and regulations regarding procurements. These sections are often separate appendices or annexes, allowing standardized legal contract language to be used.

A complex project may involve managing multiple contracts simultaneously or in sequence. In such cases, each contract life cycle may begin and end during any phase of the project life cycle. The buyer-seller relationship may exist at many levels on any one project, and between organizations internal to and external to the acquiring organization.

Depending on the application area, the seller may be identified as a contractor, vendor, service provider, or supplier. The buyer may be the owner of the final product, a subcontractor, the acquiring organization, a service requestor, or the purchaser. The seller can be viewed during the contract life cycle first as a bidder, then as the selected source, and then as the contracted supplier or vendor.



The winning bidder may manage the work as a project. In such cases:

- ◆ The buyer becomes the customer to subcontractors, suppliers, and service providers and is therefore a key project stakeholder from the seller's perspective.
- ◆ The seller's project management team may be concerned with all the processes involved in performing the work or providing the services.
- ◆ Terms and conditions of the contract and the procurement statement of work (SOW) become key inputs to many of the seller's management processes. The contract can actually contain the inputs (e.g., major deliverables, key milestones, cost objectives) or it can limit the project team's options (for example, buyer approval of staffing decisions is often required on IT integration projects). The procurement SOW may have other names, such as the technical statement of work.
- ◆ The seller itself may become a buyer of lower-tiered products, services, and materials from subcontractors and suppliers.

In this section, it is assumed that the buyer of an item for the project is assigned to the project team and/or is part of the larger organization. The seller is assumed to be providing services and/or materials to the project and is usually outside the performing organization. For some projects, the seller role may be filled by a group or function that is part of the performing organization but external to the project. For larger, more complex projects, the seller may become part of an integrated project team after the contract is awarded.

For smaller organizations or startup companies and those without a purchasing, contracting, or procurement department, the project manager may assume the purchasing authority role to negotiate and sign contracts directly (decentralized purchasing). For more mature organizations, the actual procurement and contracting functions will be carried out by a separate department with the specific role to purchase, negotiate, and sign contracts (centralized purchasing).

In international contracting, the legal jurisdictions under which the contracts will be administered are clearly spelled out in the contract. In most cases, the seller is an external contractor who is bound by a formal contractual relationship.

TRENDS AND EMERGING PRACTICES IN PROCUREMENT MANAGEMENT

There are a number of major trends in software tools, risk, processes, logistics, and technology with different industries that can affect the success rate of projects. Trends and emerging practices for Project Procurement Management include but are not limited to:

- ◆ **Advances in tools.** There has been significant improvement in the development of tools to manage the procurement and implementation phases of a project. Online tools for procurement now give the buyers a single point where procurements can be advertised and provide sellers with a single source to find procurement documents and complete them directly online. In the construction/engineering/infrastructure field, the increasing use of the building information model (BIM) in software tools has been shown to save significant amounts of time and money on projects using it. This approach can substantially reduce construction claims, thereby reducing both costs and schedule. Major companies and governments worldwide are beginning to mandate the use of BIM on large projects.
- ◆ **More advanced risk management.** An increasing trend in risk management is to write contracts that accurately allocate specific risks to those entities most capable of managing them. No contractor is capable of managing all the possible major risks on a project. The buyer will be required to accept the risks that the contractors do not have control over, such as changing corporate policies in the buying organization, changing regulatory requirements, and other risks from outside the project. Contracts may specify that risk management be performed as part of the contract.
- ◆ **Changing contracting processes.** There has been a significant growth in megaprojects in the past several years, particularly in the areas of infrastructure development and engineering projects. Multibillion-dollar projects are now common. A large proportion of these involve international contracts with multiple contractors from many countries and are inherently more risky than projects using only local contractors. Increasingly, the contractor works closely with the client in the procurement process to take advantage of discounts through quantity purchases or other special considerations. For these projects, the use of internationally recognized standard contract forms is increasing in order to reduce problems and claims during execution.

- ◆ **Logistics and supply chain management.** Because so many large engineering, construction infrastructure projects are done through multiple international contractors, the management of the flow of materials becomes critical to successful completion. For long-lead items, both the manufacture of the items and their transportation to the project site become schedule-drivers. In the IT field, a long-lead item may require ordering 2 to 3 months in advance. In complex construction projects, long-lead items may require ordering 1 to 2 years in advance or longer. For these projects, long-lead items may be procured in advance of other procurement contracts to meet the planned project completion date. It is possible to begin contracting for these long-lead materials, supplies, or equipment before the final design of the end product itself is completed based on the known requirements identified in the top-level design. The management of the supply chain is an area of increasing emphasis by the contractor's project team. Not only are primary sources of supplies identified early in the project, but secondary, back-up sources are also generally identified. Many countries around the world require international contractors to purchase certain minimum percentages of material and supplies from local vendors.
- ◆ **Technology and stakeholder relations.** Publicly funded projects are under increasing scrutiny. A trend in infrastructure and commercial construction projects is the use of technology including web cameras (webcams) to improve stakeholder communications and relations. During construction, one or more webcams are installed on the site, with periodic updates to a publicly available website. The progress on the project can be viewed on the Internet by all stakeholders. Video data can also be stored, allowing analysis if a claim arises. Some projects have discovered that the use of webcams minimizes disputes relating to the construction work on site, as the webcam has recorded the events, so there should be no disagreement about the facts of the matter.
- ◆ **Trial engagements.** Not every seller is well suited for an organization's environment. Therefore, some projects will engage several candidate sellers for initial deliverables and work products on a paid basis before making the full commitment to a larger portion of the project scope. This accelerates momentum by allowing the buyer to evaluate potential partners, while simultaneously making progress on project work.

TAILORING CONSIDERATIONS

Because each project is unique, the project manager may need to tailor the way that Project Procurement Management processes are applied. Considerations for tailoring include but are not limited to:

- ◆ **Complexity of procurement.** Is there one main procurement or are there multiple procurements at different times with different sellers that add to the complexity of the procurements?
- ◆ **Physical location.** Are the buyers and sellers in the same location, or reasonably close, or in different time zones, countries, or continents?
- ◆ **Governance and regulatory environment.** Are local laws and regulations regarding procurement activities integrated with the organization's procurement policies? How does this affect contract auditing requirements?
- ◆ **Availability of contractors.** Are there available contractors who are capable of performing the work?

CONSIDERATIONS FOR AGILE/ADAPTIVE ENVIRONMENTS

In agile environments, specific sellers may be used to extend the team. This collaborative working relationship can lead to a shared risk procurement model where both the buyer and the seller share in the risk and rewards associated with a project.

Larger projects may use an adaptive approach for some deliverables and a more stable approach for other parts. In these cases, a governing agreement such as a master services agreement (MSA) may be used for the overall engagement, with the adaptive work being placed in an appendix or supplement. This allows changes to occur on the adaptive scope without impacting the overall contract.



12.1 PLAN PROCUREMENT MANAGEMENT

Plan Procurement Management is the process of documenting project procurement decisions, specifying the approach and identifying potential sellers. The key benefit of this process is that it determines whether to acquire goods and services from outside the project and, if so, what to acquire as well as how and when to acquire it. Goods and services may be procured from other parts of the performing organization or from external sources. This process is performed once or at predefined points in the project. The inputs, tools and techniques, and outputs of this process are depicted in Figure 12-2. Figure 12-3 depicts the data flow diagram of the process.

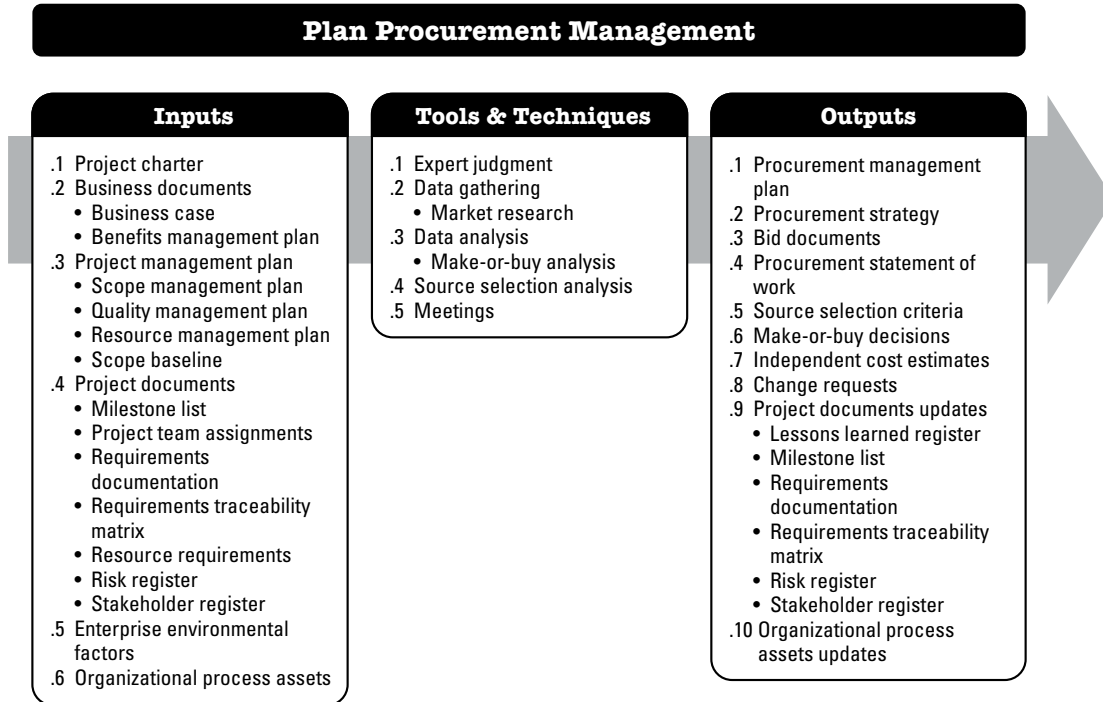

Figure 12-2. Plan Procurement Management: Inputs, Tools & Techniques, and Outputs

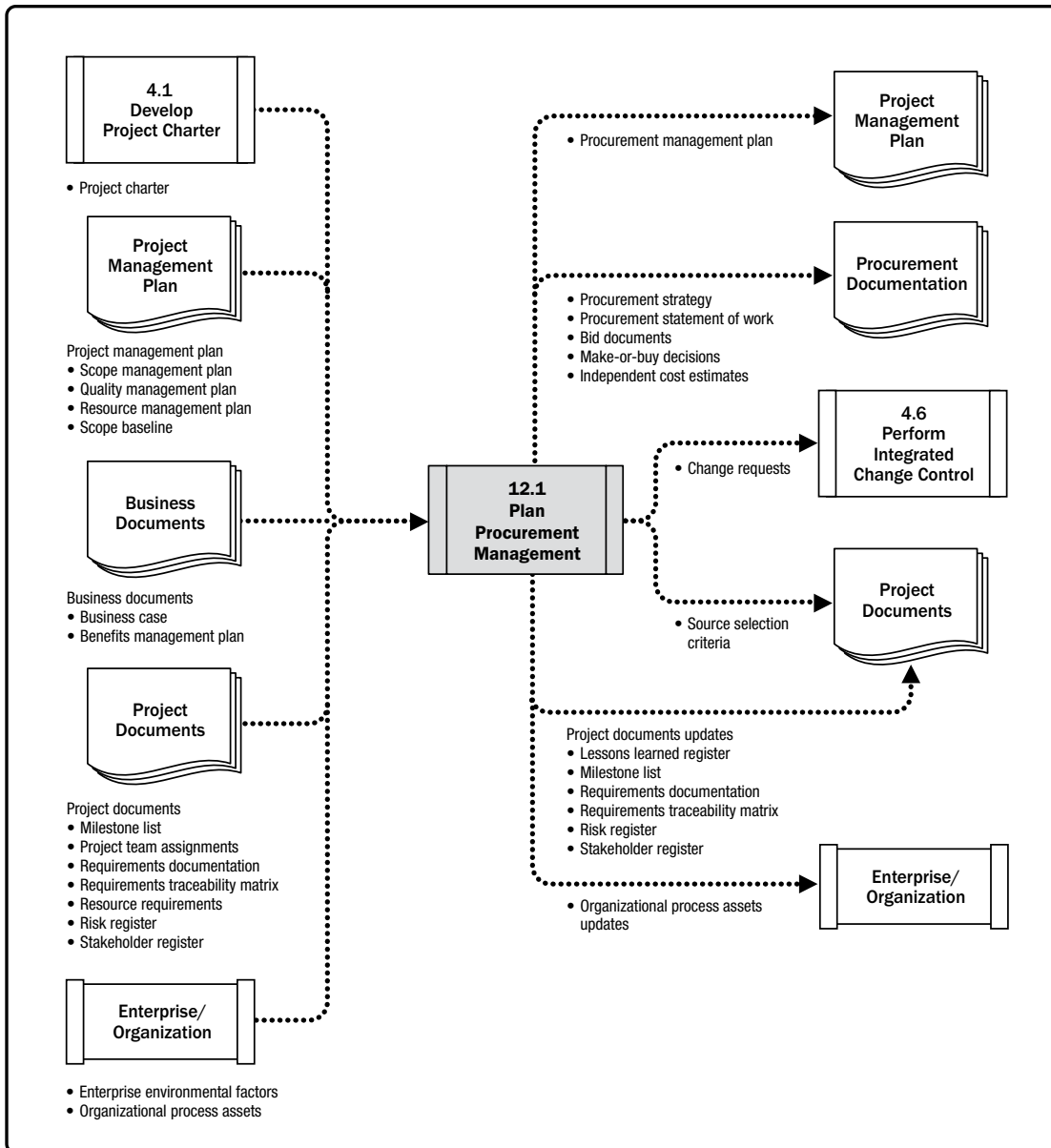

Figure 12-3. Plan Procurement Management: Data Flow Diagram

Defining roles and responsibilities related to procurement should be done early in the Plan Procurement Management process. The project manager should ensure that the project team is staffed with procurement expertise at the level required for the project. Participants in the procurement process may include personnel from the purchasing or procurement department as well as personnel from the buying organization's legal department. These responsibilities should be documented in the procurement management plan.

Typical steps might be:

- ◆ Prepare the procurement statement of work (SOW) or terms of reference (TOR).
- ◆ Prepare a high-level cost estimate to determine the budget.
- ◆ Advertise the opportunity.
- ◆ Identify a short list of qualified sellers.
- ◆ Prepare and issue bid documents.
- ◆ Prepare and submit proposals by the seller.
- ◆ Conduct a technical evaluation of the proposals including quality.
- ◆ Perform a cost evaluation of the proposals.
- ◆ Prepare the final combined quality and cost evaluation to select the winning proposal.
- ◆ Finalize negotiations and sign contract between the buyer and the seller.

The requirements of the project schedule can significantly influence the strategy during the Plan Procurement Management process. Decisions made in developing the procurement management plan can also influence the project schedule and are integrated with the Develop Schedule process, the Estimate Activity Resources process, and make-or-buy decisions.

12.1.1 PLAN PROCUREMENT MANAGEMENT: INPUTS

12.1.1.1 PROJECT CHARTER

Described in Section 4.1.3.1. The project charter contains the objectives, project description, summary milestones, and the preapproved financial resources.

12.1.1.2 BUSINESS DOCUMENTS

Described in Section 1.2.6. The business documents include the following:

- ◆ **Business case.** The procurement strategy and business case need to be aligned to ensure the business case remains valid.
- ◆ **Benefits management plan.** The benefits management plan describes when specific project benefits are expected to be available, which will drive procurement dates and contract language.

12.1.1.3 PROJECT MANAGEMENT PLAN

Described in Section 4.2.3.1. Project management plan components include but are not limited to:

- ◆ **Scope management plan.** Described in Section 5.1.3.1. The scope management plan describes how the scope of work by the contractors will be managed through the execution phase of the project.
- ◆ **Quality management plan.** Described in Section 8.1.3.1. The quality management plan contains the applicable industry standards and codes the project is required to follow. This information is used in bidding documents such as the RFP and will eventually be referenced in the contract. This information may be used in supplier prequalification or as part of the selection criteria.
- ◆ **Resource management plan.** Described in Section 9.1.3.1. The resource management plan has information on which resources will be purchased or leased, along with any assumptions or constraints that would influence the procurement.
- ◆ **Scope baseline.** Described in Section 5.4.3.1. The scope baseline contains the scope statement, WBS, and WBS dictionary. Early in the project, the project scope may still be evolving. The elements of the scope that are known are used to develop the statement of work (SOW) and the terms of reference (TOR).

12.1.1.4 PROJECT DOCUMENTS

Project documents that can be considered as inputs for this process include but are not limited to:

- ◆ **Milestone list.** Described in Section 6.2.3.3. This list of major milestones show when the sellers are required to deliver their results.
- ◆ **Project team assignments.** Described in Section 9.3.3.2. The project team assignments contain information on the skills and abilities of the project team and their availability to support the procurement activities. If the project team does not have the skills to perform the procurement activities for which they are responsible, additional resources will need to be acquired or training will need to be provided, or both.

- ◆ **Requirements documentation.** Described in Section 5.2.3.1. Requirements documentation may include:
 - Technical requirements that the seller is required to satisfy, and
 - Requirements with contractual and legal implications that may include health, safety, security, performance, environmental, insurance, intellectual property rights, equal employment opportunity, licenses, permits, and other nontechnical requirements.
- ◆ **Requirements traceability matrix.** Described in Section 5.2.3.2. The requirements traceability matrix links product requirements from their origin to the deliverables that satisfy them.
- ◆ **Resource requirements.** Described in Section 9.2.3.1. Resource requirements contain information on specific needs such as team and physical resources that may need to be acquired.
- ◆ **Risk register.** Described in Section 11.2.3.1. The risk register provides the list of risks, along with the results of risk analysis and risk response planning. Some risks are transferred via a procurement agreement.
- ◆ **Stakeholder register.** Described in Section 13.1.3.1. The stakeholder register provides details on the project participants and their interests in the project, including regulatory agencies, contracting personnel, and legal personnel.

12.1.1.5 ENTERPRISE ENVIRONMENTAL FACTORS

The enterprise environmental factors that can influence the Plan Procurement Management process include but are not limited to:

- ◆ Marketplace conditions;
- ◆ Products, services, and results that are available in the marketplace;
- ◆ Sellers, including their past performance or reputation;
- ◆ Typical terms and conditions for products, services, and results or for the specific industry;
- ◆ Unique local requirements, such as regulatory requirements for local labor or sellers;
- ◆ Legal advice regarding procurements;
- ◆ Contract management systems, including procedures for contract change control;
- ◆ Established multi-tier supplier system of prequalified sellers based on prior experience; and
- ◆ Financial accounting and contract payments system.

12.1.1.6 ORGANIZATIONAL PROCESS ASSETS

The various types of contractual agreements used by the organization also influence decisions for the Plan Procurement Management process. The organizational process assets that can influence the Plan Procurement Management process include but are not limited to:

- ◆ **Preapproved seller lists.** Lists of sellers that have been properly vetted can streamline the steps needed to advertise the opportunity and shorten the timeline for the seller selection process.
- ◆ **Formal procurement policies, procedures, and guidelines.** Most organizations have formal procurement policies and buying organizations. When such procurement support is not available, the project team should supply both the resources and the expertise to perform such procurement activities.
- ◆ **Contract types.** All legal contractual relationships generally fall into one of two broad families: either fixed-price or cost-reimbursable. Also, there is a third hybrid type commonly used called the time and materials contract. The more popular contract types in use are discussed below as discrete types, but, in practice, it is not unusual to combine one or more types into a single procurement.
 - *Fixed-price contracts.* This category of contracts involves setting a fixed total price for a defined product, service, or result to be provided. These contracts should be used when the requirements are well defined and no significant changes to the scope are expected. Types of fixed-price contract include:
 - *Firm fixed price (FFP).* The most commonly used contract type is the FFP. It is favored by most buying organizations because the price for goods is set at the outset and not subject to change unless the scope of work changes.
 - *Fixed price incentive fee (FPIF).* This fixed-price arrangement gives the buyer and seller some flexibility in that it allows for deviation from performance, with financial incentives tied to achieving agreed-upon metrics. Typically, such financial incentives are related to cost, schedule, or technical performance of the seller. Under FPIF contracts, a price ceiling is set, and all costs above the price ceiling are the responsibility of the seller.
 - *Fixed price with economic price adjustments (FPEPA).* This type is used whenever the seller's performance period spans a considerable period of years, or if the payments are made in a different currency. It is a fixed-price contract, but with a special provision allowing for predefined final adjustments to the contract price due to changed conditions, such as inflation changes or cost increases (or decreases) for specific commodities.

- ◆ **Cost-reimbursable contracts.** This category of contract involves payments (cost reimbursements) to the seller for all legitimate actual costs incurred for completed work, plus a fee representing seller profit. This type should be used if the scope of work is expected to change significantly during the execution of the contract. Variations can include:
 - *Cost plus fixed fee (CPFF).* The seller is reimbursed for all allowable costs for performing the contract work and receives a fixed-fee payment calculated as a percentage of the initial estimated project costs. Fee amounts do not change unless the project scope changes.
 - *Cost plus incentive fee (CPIF).* The seller is reimbursed for all allowable costs for performing the contract work and receives a predetermined incentive fee based on achieving certain performance objectives as set forth in the contract. In CPIF contracts, if the final costs are less or greater than the original estimated costs, then both the buyer and seller share costs from the departures based upon a prenegotiated cost-sharing formula, for example, an 80/20 split over/under target costs based on the actual performance of the seller.
 - *Cost plus award fee (CPAF).* The seller is reimbursed for all legitimate costs, but the majority of the fee is earned based on the satisfaction of certain broad subjective performance criteria that are defined and incorporated into the contract. The determination of fee is based solely on the subjective determination of seller performance by the buyer and is generally not subject to appeals.
- ◆ **Time and material contracts (T&M).** Time and material contracts (also called time and means) are a hybrid type of contractual arrangement with aspects of both cost-reimbursable and fixed-price contracts. They are often used for staff augmentation, acquisition of experts, and any outside support when a precise statement of work cannot be quickly prescribed.

12.1.2 PLAN PROCUREMENT MANAGEMENT: TOOLS AND TECHNIQUES

12.1.2.1 EXPERT JUDGMENT

Described in Section 4.1.2.1. Expertise should be considered from individuals or groups with specialized knowledge or training in the following topics:

- ◆ Procurement and purchasing,
- ◆ Contract types and contract documents, and
- ◆ Regulations and compliance topics.

12.1.2.2 DATA GATHERING

A data-gathering technique that can be used for this process includes but is not limited to market research. Market research includes examination of industry and specific seller capabilities. Procurement teams may leverage information gained at conferences, online reviews, and a variety of sources to identify market capabilities. The team may also refine specific procurement objectives to leverage maturing technologies while balancing risks associated with the breadth of sellers who can provide the desired materials or services.

12.1.2.3 DATA ANALYSIS

Data analysis techniques that can be used for this process include but are not limited to make-or-buy analysis. A make-or-buy analysis is used to determine whether work or deliverables can best be accomplished by the project team or should be purchased from outside sources. Factors to consider in the make-or-buy decision include the organization's current resource allocation and their skills and abilities, the need for specialized expertise, the desire to not expand permanent employment obligations, and the need for independent expertise. It also includes evaluating the risks involved with each make-or-buy decision.

Make-or-buy analysis may use payback period, return on investment (ROI), internal rate of return (IRR), discounted cash flow, net present value (NPV), benefit/cost analysis (BCA), or other techniques in order to decide whether to include something as part of the project or purchase it externally.

12.1.2.4 SOURCE SELECTION ANALYSIS

It is necessary to review the prioritization of the competing demands for the project before deciding on the selection method. Since competitive selection methods may require sellers to invest a large amount of time and resources upfront, it is a good practice to include the evaluation method in the procurement documents so bidders know how they will be evaluated. Commonly used selection methods include the following:

- ◆ **Least cost.** The least cost method may be appropriate for procurements of a standard or routine nature where well-established practices and standards exist and from which a specific and well-defined outcome is expected, which can be executed at different costs.
- ◆ **Qualifications only.** The qualifications only selection method applies when the time and cost of a full selection process would not make sense because the value of the procurement is relatively small. The buyer establishes a short list and selects the bidder with the best credibility, qualifications, experience, expertise, areas of specialization, and references.

- ◆ **Quality-based/highest technical proposal score.** The selected firm is asked to submit a proposal with both technical and cost details and is then invited to negotiate the contract if the technical proposal proves acceptable. Using this method, technical proposals are first evaluated based on the quality of the technical solution offered. The seller who submitted the highest-ranked technical proposal is selected if their financial proposal can be negotiated and accepted.
- ◆ **Quality and cost-based.** The quality and cost-based method allows cost to be included as a factor in the seller selection process. In general, when risk and/or uncertainty are greater for the project, quality should be a key element when compared to cost.
- ◆ **Sole source.** The buyer asks a specific seller to prepare technical and financial proposals, which are then negotiated. Since there is no competition, this method is acceptable only when properly justified and should be viewed as an exception.
- ◆ **Fixed budget.** The fixed-budget method requires disclosing the available budget to invited sellers in the RFP and selecting the highest-ranking technical proposal within the budget. Because sellers are subject to a cost constraint, they will adapt the scope and quality of their offer to that budget. The buyer should therefore ensure that the budget is compatible with the SOW and that the seller will be able to perform the tasks within the budget. This method is appropriate only when the SOW is precisely defined, no changes are anticipated, and the budget is fixed and cannot be exceeded.

12.1.2.5 MEETINGS

Research alone may not provide specific information to formulate a procurement strategy without additional information interchange meetings with potential bidders. By collaborating with potential bidders, the organization purchasing the material or service may benefit while the seller can influence a mutually beneficial approach or product. Meetings can be used to determine the strategy for managing and monitoring the procurement.

12.1.3 PLAN PROCUREMENT MANAGEMENT: OUTPUTS

12.1.3.1 PROCUREMENT MANAGEMENT PLAN

The procurement management plan contains the activities to be undertaken during the procurement process. It should document whether international competitive bidding, national competitive bidding, local bidding, etc., should be done. If the project is financed externally, the sources and availability of funding should be aligned with the procurement management plan and the project schedule.

The procurement management plan can include guidance for:

- ◆ How procurement will be coordinated with other project aspects, such as project schedule development and control processes;
- ◆ Timetable of key procurement activities;
- ◆ Procurement metrics to be used to manage contracts;
- ◆ Stakeholder roles and responsibilities related to procurement, including authority and constraints of the project team when the performing organization has a procurement department;
- ◆ Constraints and assumptions that could affect planned procurements;
- ◆ The legal jurisdiction and the currency in which payments will be made;
- ◆ Determination of whether independent estimates will be used and whether they are needed as evaluation criteria;
- ◆ Risk management issues including identifying requirements for performance bonds or insurance contracts to mitigate some forms of project risk; and
- ◆ Prequalified sellers, if any, to be used.

A procurement management plan can be formal or informal, can be highly detailed or broadly framed, and is based upon the needs of each project.



12.1.3.2 PROCUREMENT STRATEGY

Once the make-or-buy analysis is complete and the decision is made to acquire from outside the project, a procurement strategy should be identified. The objective of the procurement strategy is to determine the project delivery method, the type of legally binding agreement(s), and how the procurement will advance through the procurement phases.

- ◆ **Delivery methods.** Delivery methods are different for professional services versus construction projects.
 - For professional services, delivery methods include: buyer/services provider with no subcontracting, buyer/services provider with subcontracting allowed, joint venture between buyer and services provider, and buyer/services provider acts as the representative.
 - For industrial or commercial construction, project delivery methods include but are not limited to: turnkey, design build (DB), design bid build (DBB), design build operate (DBO), build own operate transfer (BOOT), and others.
- ◆ **Contract payment types.** Contract payment types are separate from the project delivery methods and are coordinated with the buying organization's internal financial systems. They include but are not limited to these contract types plus variations: lump sum, firm fixed price, cost plus award fees, cost plus incentive fees, time and materials, target cost, and others.
 - Fixed-price contracts are suitable when the type of work is predictable and the requirements are well defined and not likely to change.
 - Cost plus contracts are suitable when the work is evolving, likely to change, or not well defined.
 - Incentives and awards may be used to align the objectives of buyer and seller.
- ◆ **Procurement phases.** The procurement strategy can also include information on procurement phases. Information may include:
 - Sequencing or phasing of the procurement, a description of each phase and the specific objectives of each phase;
 - Procurement performance indicators and milestones to be used in monitoring;
 - Criteria for moving from phase to phase;
 - Monitoring and evaluation plan for tracking progress; and
 - Process for knowledge transfer for use in subsequent phases.

12.1.3.3 BID DOCUMENTS

Bid documents are used to solicit proposals from prospective sellers. Terms such as bid, tender, or quotation are generally used when the seller selection decision is based on price (as when buying commercial or standard items), while a term such as proposal is generally used when other considerations such as technical capability or technical approach are the most important. Specific procurement terminology used may vary by industry and location of the procurement.

Depending on the goods or services needed, the bidding documents can include a request for information, request for quotation, request for proposal, or other appropriate procurement documents. The conditions involving their use are presented below:

- ◆ **Request for information (RFI).** An RFI is used when more information on the goods and services to be acquired is needed from the sellers. It will typically be followed by an RFQ or RFP.
- ◆ **Request for quotation (RFQ).** An RFQ is commonly used when more information is needed on how vendors would satisfy the requirements and/or how much it will cost.
- ◆ **Request for proposal (RFP).** An RFP is used when there is a problem in the project and the solution is not easy to determine. This is the most formal of the “request for” documents and has strict procurement rules for content, timeline, and seller responses.

The buyer structures procurement documents to facilitate an accurate and complete response from each prospective seller and to facilitate easy evaluation of the responses. These documents include a description of the desired form of the response, the relevant procurement SOW, and any required contractual provisions.

The complexity and level of detail of the procurement documents should be consistent with the value of, and risks associated with, the planned procurement. Procurement documents are required to be sufficiently detailed to ensure consistent, appropriate responses, but flexible enough to allow consideration of any seller suggestions for better ways to satisfy the same requirements.

12.1.3.4 PROCUREMENT STATEMENT OF WORK

The statement of work (SOW) for each procurement is developed from the project scope baseline and defines only that portion of the project scope that is to be included within the related contract. The SOW describes the procurement item in sufficient detail to allow prospective sellers to determine if they are capable of providing the products, services, or results. Sufficient detail can vary based on the nature of the item, the needs of the buyer, or the expected contract form. Information included in a SOW can include specifications, quantity desired, quality levels, performance data, period of performance, work location, and other requirements.

The procurement SOW should be clear, complete, and concise. It includes a description of any collateral services required, such as performance reporting or post-project operational support for the procured item. The SOW can be revised as required as it moves through the procurement process until incorporated into a signed agreement.

The phrase *terms of reference* (TOR) is sometimes used when contracting for services. Similar to the procurement SOW, a TOR typically includes these elements:

- ◆ Tasks the contractor is required to perform as well as specified coordination requirements;
- ◆ Standards the contractor will fulfill that are applicable to the project;
- ◆ Data that needs to be submitted for approval;
- ◆ Detailed list of all data and services that will be provided to the contractor by the buyer for use in performing the contract, if applicable; and
- ◆ Definition of the schedule for initial submission and the review/approval time required.

12.1.3.5 SOURCE SELECTION CRITERIA

In choosing evaluation criteria, the buyer seeks to ensure that the proposal selected will offer the best quality for the services required. The source selection criteria may include but are not limited to:

- ◆ Capability and capacity;
- ◆ Product cost and life cycle cost;
- ◆ Delivery dates;
- ◆ Technical expertise and approach;
- ◆ Specific relevant experience;
- ◆ Adequacy of the proposed approach and work plan in responding to the SOW;
- ◆ Key staff's qualifications, availability, and competence;
- ◆ Financial stability of the firm;
- ◆ Management experience; and
- ◆ Suitability of the knowledge transfer program, including training.

For international projects, evaluation criteria may include “local content” requirements, for example, participation by nationals among proposed key staff.

The specific criteria may be a numerical score, color-code, or a written description of how well the seller satisfies the buying organization’s needs. The criteria will be part of a weighting system that can be used to select a single seller that will be asked to sign a contract and establish a negotiating sequence by ranking all the proposals by the weighted evaluation scores assigned to each proposal.

12.1.3.6 MAKE-OR-BUY DECISIONS

A make-or-buy analysis results in a decision as to whether particular work can best be accomplished by the project team or needs to be purchased from outside sources.

12.1.3.7 INDEPENDENT COST ESTIMATES

For large procurements, the procuring organization may elect to either prepare its own independent estimate or have a cost estimate prepared by an outside professional estimator to serve as a benchmark on proposed responses. Significant differences in cost estimates can be an indication that the procurement SOW was deficient or ambiguous, or that the prospective sellers either misunderstood or failed to respond fully to the procurement SOW.

12.1.3.8 CHANGE REQUESTS

Described in Section 4.3.3.4. A decision that involves procuring goods, services, or resources may require a change request. Other decisions during procurement planning can also create the need for additional change requests. Changes to the project management plan, its subsidiary plans, and other components may result in change requests that impact procurement actions. Change requests are processed for review and disposition through the Perform Integrated Change Control process (Section 4.6).

12.1.3.9 PROJECT DOCUMENTS UPDATES

Project documents that may be updated as a result of carrying out this process include but are not limited to:

- ◆ **Lessons learned register.** Described in Section 4.4.3.1. The lessons learned register is updated with any relevant lessons regarding regulations and compliance, data gathering, data analysis, and source selection analysis.
- ◆ **Milestone list.** Described in Section 6.2.3.3. This list of major milestones shows when the sellers are expected to deliver their results.
- ◆ **Requirements documentation.** Described in Section 5.2.3.1. Requirements documentation may include:
 - Technical requirements that the seller is required to satisfy, and
 - Requirements with contractual and legal implications that may include health, safety, security, performance, environmental, insurance, intellectual property rights, equal employment opportunity, licenses, permits, and other nontechnical requirements.
- ◆ **Requirements traceability matrix.** Described in Section 5.2.3.2. The requirements traceability matrix links product requirements from their origin to the deliverables that satisfy them.
- ◆ **Risk register.** Described in Section 11.2.3.1. Each approved seller comes with its own unique set of risks, depending on the seller's organization, the duration of the contract, the external environment, the project delivery method, the type of contracting vehicle chosen, and the final agreed-upon price.
- ◆ **Stakeholder register.** Described in Section 13.1.3.1. The stakeholder register is updated with any additional information on stakeholders, particularly regulatory agencies, contracting personnel, and legal personnel.

12.1.3.10 ORGANIZATIONAL PROCESS ASSETS UPDATES

Organizational process assets that are updated as a result of the Plan Procurement Management process include but are not limited to information on qualified sellers.

For projects with few procurements and relatively simple procurements, some of these outputs may be combined. However, for projects with large, complex procurements and where much of the work is done by contractors, there are several different types of documentation. Table 12-1 is a representative list of common types of documents used in procurements and some of their contents. Given the legal nature of procurements, this list should not be considered prescriptive, but rather it should be used as a general outline of types of documents and contents needed to conduct procurement. The organization, environment, and legal constraints dictate the required procurement documents and information needed for the project.

Table 12-1. Comparison of Procurement Documentation

Procurement Management Plan	Procurement Strategy	Statement of Work	Bid Documents
How procurement work will be coordinated and integrated with other project work, particularly with resources, schedule, and budget	Procurement delivery methods	Description of the procurement item	Request for information (RFI), Request for quote (RFQ), Request for proposal (RFP)
Timetable for key procurement activities	Type of agreements	Specifications, quality requirements and performance metrics	
Procurement metrics to manage the contract	Procurement phases	Description of collateral services required	
Responsibilities of all stakeholders		Acceptance methods and criteria	
Procurement assumptions and constraints		Performance data and other reports required	
Legal jurisdiction and currency used for payment		Quality	
Information on independent estimates		Period and place of performance	
Risk management issues		Currency; payment schedule	
Prequalified sellers, if applicable		Warranty	

12.2 CONDUCT PROCUREMENTS

Conduct Procurements is the process of obtaining seller responses, selecting a seller, and awarding a contract. The key benefit of this process is that it selects a qualified seller and implements the legal agreement for delivery. The end results of the process are the established agreements including formal contracts. This process is performed periodically throughout the project as needed. The inputs, tools and techniques, and outputs of the Conduct Procurements process are depicted in Figure 12-4. Figure 12-5 depicts the data flow diagram for the process.

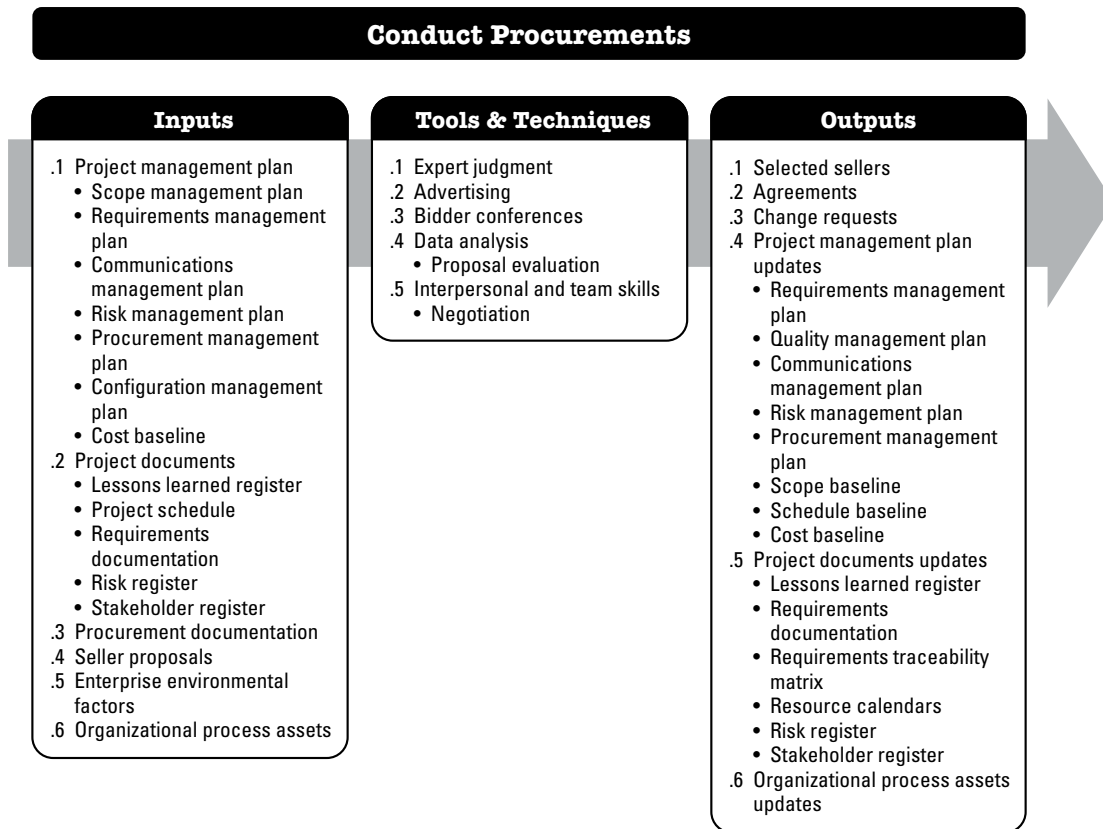

Figure 12-4. Conduct Procurements: Inputs, Tools & Techniques, and Outputs

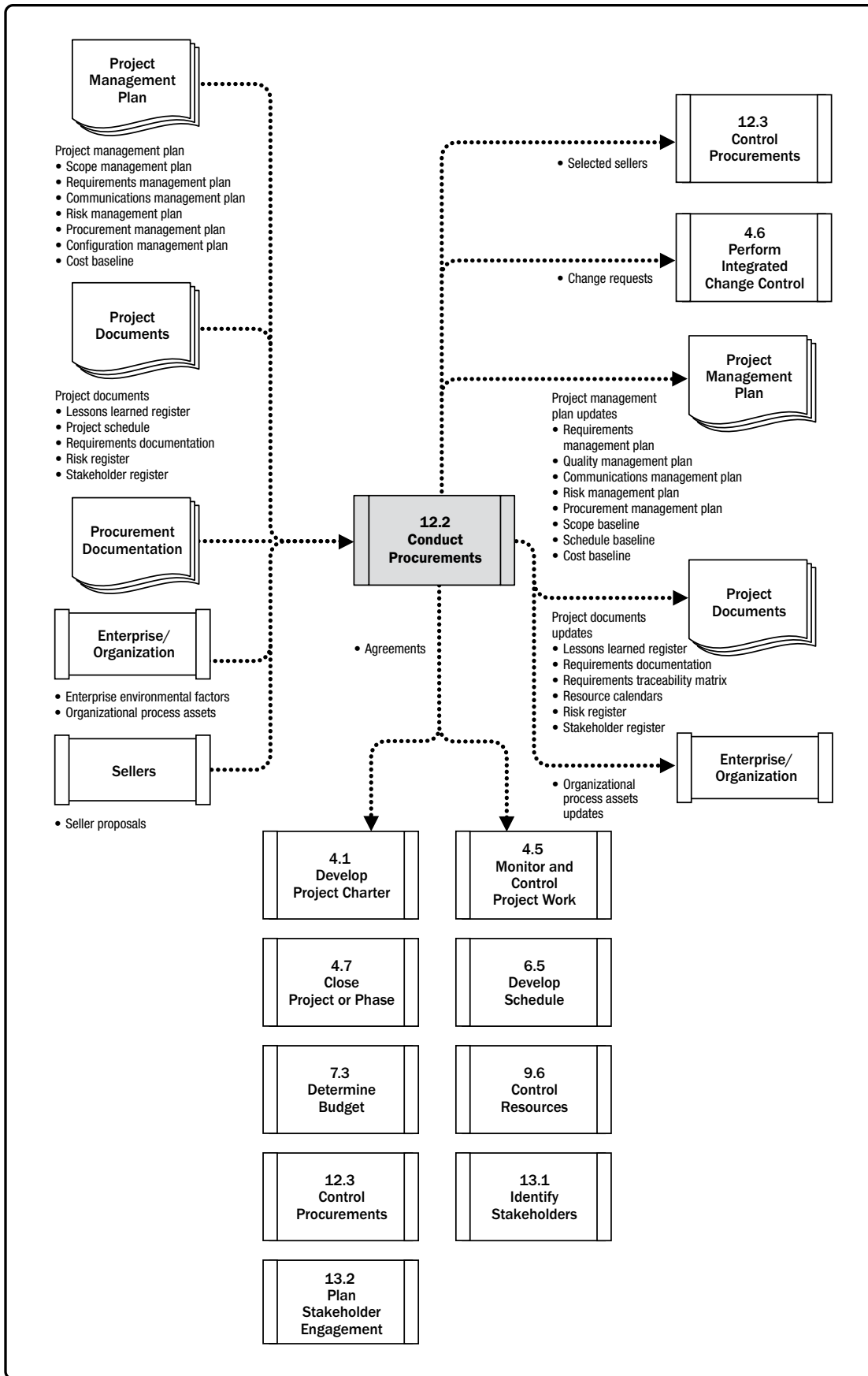

Figure 12-5. Conduct Procurements: Data Flow Diagram

12.2.1 CONDUCT PROCUREMENTS: INPUTS

12.2.1.1 PROJECT MANAGEMENT PLAN

Described in Section 4.2.3.1. Project management plan components include but are not limited to:

- ◆ **Scope management plan.** Described in Section 5.1.3.1. The scope management plan describes how the overall scope of work will be managed, including the scope performed by sellers.
- ◆ **Requirements management plan.** Described in Section 5.1.3.2. The requirements management plan describes how requirements will be analyzed, documented, and managed. The requirements management plan may include how sellers will manage the requirements they are under agreement to satisfy.
- ◆ **Communications management plan.** Described in Section 10.1.3.1. The communications management plan describes how communications between buyers and sellers will be conducted.
- ◆ **Risk management plan.** Described in Section 11.1.3.1. The risk management plan is a component of the project management plan and describes how risk management activities will be structured and performed for the project.
- ◆ **Procurement management plan.** Described in Section 12.1.3.1. The procurement management plan contains the activities to be undertaken during the Conduct Procurements process.
- ◆ **Configuration management plan.** Described in Section 5.6.1.1. The configuration management plan defines those items that are configurable, those items that require formal change control, and the process for controlling changes to such items. It includes formats and processes for how sellers will provide configuration management in a way that is consistent with the buyer's approach.
- ◆ **Cost baseline.** Described in Section 7.3.3.1. The cost baseline includes the budget for the procurement as well as costs associated with managing the procurement process and sellers.

12.2.1.2 PROJECT DOCUMENTS

Project documents that can be considered as inputs for this process include but are not limited to:

- ◆ **Lessons learned register.** Described in Section 4.4.3.1. Lessons learned earlier in the project with regard to conducting procurements can be applied to later phases in the project to improve the efficiency of this process.
- ◆ **Project schedule.** Described in Section 6.5.3.2. The project schedule identifies the start and end dates of project activities, including procurement activities. It also defines when contractor deliverables are due.

- ◆ **Requirements documentation.** Described in Section 5.2.3.1. Requirements documentation may include:
 - Technical requirements the seller is required to satisfy, and
 - Requirements with contractual and legal implications that may include health, safety, security, performance, environmental, insurance, intellectual property rights, equal employment opportunity, licenses, permits, and other nontechnical requirements.
- ◆ **Risk register.** Described in Section 11.2.3.1. Each approved seller comes with its own unique set of risks, depending on the seller's organization, the duration of the contract, the external environment, the project delivery method, the type of contracting vehicle chosen, and the final agreed-upon price.
- ◆ **Stakeholder register.** Described in Section 13.1.3.1. This document contains all of the details about the identified stakeholders.

12.2.1.3 PROCUREMENT DOCUMENTATION

Procurement documentation provides a written record used in reaching the legal agreement, and may include older documents predating the current project. Procurement documentation can include:

- ◆ **Bid documents.** Described in Section 12.1.3.3. Procurement documents include the RFI, RFP, RFQ, or other documents sent to sellers so they can develop a bid response.
- ◆ **Procurement statement of work.** Described in Section 12.1.3.4. The procurement statement of work (SOW) provides sellers with a clearly stated set of goals, requirements, and outcomes from which they can provide a quantifiable response.
- ◆ **Independent cost estimates.** Described in Section 12.1.3.7. Independent cost estimates are developed either internally or by using external resources and provide a reasonableness check against the proposals submitted by bidders.
- ◆ **Source selection criteria.** Described in Section 12.1.3.5. These criteria describe how bidder proposals will be evaluated, including evaluation criteria and weights. For risk mitigation, the buyer may decide to sign agreements with more than one seller to mitigate damage caused by a single seller having problems that impact the overall project.



12.2.1.4 SELLER PROPOSALS

Seller proposals, prepared in response to a procurement document package, form the basic information that will be used by an evaluation body to select one or more successful bidders (sellers). If the seller is going to submit a price proposal, good practice is to require that it be separate from the technical proposal. The evaluation body reviews each submitted proposal according to the source selection criteria and selects the seller that can best satisfy the buying organization's requirements.

12.2.1.5 ENTERPRISE ENVIRONMENTAL FACTORS

The enterprise environmental factors that can influence the Conduct Procurements Process include:

- ◆ Local laws and regulations regarding procurements;
- ◆ Local laws and regulations ensuring that the major procurements involve local sellers;
- ◆ External economic environment constraining procurement processes;
- ◆ Marketplace conditions;
- ◆ Information on relevant past experience with sellers, both good and bad;
- ◆ Prior agreements already in place; and
- ◆ Contract management systems.

12.2.1.6 ORGANIZATIONAL PROCESS ASSETS

The organizational process assets that can influence the Conduct Procurements process include but are not limited to:

- ◆ List of preferred sellers that have been prequalified,
- ◆ Organizational policies that influence the selection of a seller,
- ◆ Specific organizational templates or guidelines that will determine the way agreements are drafted and built, and
- ◆ Financial policies and procedures regarding invoicing and payment processes.

12.2.2 CONDUCT PROCUREMENTS: TOOLS AND TECHNIQUES

12.2.2.1 EXPERT JUDGMENT

Described in Section 4.1.2.1 Expertise should be considered from individuals or groups with specialized knowledge or training in the following topics:

- ◆ Proposal evaluation;
- ◆ Technical or subject matter;
- ◆ Relevant functional areas such as finance, engineering, design, development, supply chain management, etc.;
- ◆ Industry regulatory environment;
- ◆ Laws, regulations, and compliance requirements; and
- ◆ Negotiation.

12.2.2.2 ADVERTISING

Advertising is communicating with users or potential users of a product, service, or result. Existing lists of potential sellers often can be expanded by placing advertisements in general circulation publications such as selected newspapers or in specialty trade publications. Most government jurisdictions require public advertising or online posting of pending government contracts.

12.2.2.3 BIDDER CONFERENCES

Bidder conferences (also called contractor conferences, vendor conferences, and pre-bid conferences) are meetings between the buyer and prospective sellers prior to proposal submittal. They are used to ensure that all prospective bidders have a clear and common understanding of the procurement and no bidders receive preferential treatment.

12.2.2.4 DATA ANALYSIS

A data analysis technique that can be used for this process includes but is not limited to proposal evaluation. Proposals are evaluated to ensure they are complete and respond in full to the bid documents, procurement statement of work, source selection criteria, and any other documents that went out in the bid package.

12.2.2.5 INTERPERSONAL AND TEAM SKILLS

Interpersonal and team skills that can be used for this process include negotiation. Negotiation is a discussion aimed at reaching an agreement. Procurement negotiation clarifies the structure, rights, and obligations of the parties and other terms of the purchases so that mutual agreement can be reached prior to signing the contract. Final document language reflects all agreements reached. Negotiation concludes with a signed contract document or other formal agreement that can be executed by both buyer and seller.

The negotiation should be led by a member of the procurement team that has the authority to sign contracts. The project manager and other members of the project management team may be present during negotiation to provide assistance as needed.

12.2.3 CONDUCT PROCUREMENTS: OUTPUTS

12.2.3.1 SELECTED SELLERS

The selected sellers are those who have been judged to be in a competitive range based on the outcome of the proposal or bid evaluation. Final approval of complex, high-value, high-risk procurements will generally require organizational senior management approval prior to award.

12.2.3.2 AGREEMENTS

A contract is a mutually binding agreement that obligates the seller to provide the specified products, services, or results; obligates the buyer to compensate the seller; and represents a legal relationship that is subject to remedy in the courts. The major components in an agreement document will vary, and may include but are not limited to:

- ◆ Procurement statement of work or major deliverables;
- ◆ Schedule, milestones, or date by which a schedule is required;
- ◆ Performance reporting;
- ◆ Pricing and payment terms;
- ◆ Inspection, quality, and acceptance criteria;
- ◆ Warranty and future product support;
- ◆ Incentives and penalties;
- ◆ Insurance and performance bonds;
- ◆ Subordinate subcontractor approvals;
- ◆ General terms and conditions;
- ◆ Change request handling; and
- ◆ Termination clause and alternative dispute resolution mechanisms.

12.2.3.3 CHANGE REQUESTS

Described in Section 4.3.3.4. Change requests to the project management plan, its subsidiary plans, and other components are processed for review and disposition through the Perform Integrated Change Control process (Section 4.6).

12.2.3.4 PROJECT MANAGEMENT PLAN UPDATES

Any change to the project management plan goes through the organization's change control process via a change request. Components of the project management plan that may require a change request for the project management plan include but are not limited to:

- ◆ **Requirements management plan.** Described in Section 5.1.3.2. There may be changes to project requirements due to changes identified by sellers.
- ◆ **Quality management plan.** Described in Section 8.1.3.1. Sellers may offer alternative quality standards or alternative solutions that impact the quality approaches defined in the quality management plan.
- ◆ **Communications management plan.** Described in Section 10.1.3.1. As sellers are hired, the communications management plan is updated to incorporate their communications needs and approaches.
- ◆ **Risk management plan.** Described in Section 11.1.3.1. Each agreement and seller has its own set of risks that may require updates to the risk management plan. Specific risks are incorporated into the risk register.
- ◆ **Procurement management plan.** Described in Section 12.1.3.1. Updates may be required depending on the results of the contracting and negotiations processes.
- ◆ **Scope baseline.** Described in Section 5.4.3.1. The project WBS and deliverables documented in the scope baseline are considered when performing procurement activities. Any one or all of these may change during the procurement process.
- ◆ **Schedule baseline.** Described in Section 6.5.3.1. If there are delivery changes created by sellers that impact overall project schedule performance, the baseline schedule may need to be updated and approved to reflect the current expectations.
- ◆ **Cost baseline.** Described in Section 7.3.3.1. Contractor and materials prices can change frequently during the delivery of a project. These changes can occur because of fluctuating materials and labor prices created by the external economic environment and need to be incorporated into the cost baseline.

12.2.3.5 PROJECT DOCUMENTS UPDATES

Project documents that may be updated as a result of carrying out this process include but are not limited to:

- ◆ **Lessons learned register.** Described in Section 4.4.3.1. The lessons learned register is updated with information on challenges encountered while conducting procurements and how they could have been avoided as well as approaches that worked well.
- ◆ **Requirements documentation.** Described in Section 5.2.3.1. Requirements documentation may include:
 - Technical requirements that the seller is required to satisfy, and
 - Requirements with contractual and legal implications that may include health, safety, security, performance, environmental, insurance, intellectual property rights, equal employment opportunity, licenses, permits, and other nontechnical requirements.
- ◆ **Requirements traceability matrix.** Described in Section 5.2.3.2. As sellers are incorporated into the project's plan, the requirements register and the traceability matrix may change depending on the capabilities of the specific seller.
- ◆ **Resource calendars.** Described in Section 9.2.1.2. Schedule resource calendars may need to be updated depending on the availabilities of the sellers.
- ◆ **Risk register.** Described in Section 11.2.3.1. Each approved seller comes with its own unique set of risks, depending on the seller's organization, the duration of the contract, the external environment, the project delivery method, the type of contracting vehicle chosen, and the final agreed-upon price. Changes are made to the risk register during the contracting process, which reflect the specific risks of each seller.
- ◆ **Stakeholder register.** Described in Section 13.1.3.1. This document contains all the details about the identified stakeholders. The stakeholder register is updated as agreements are made with specific sellers.

12.2.3.6 ORGANIZATIONAL PROCESS ASSETS UPDATES

Elements of the organizational process assets that can be updated as a result of the Conduct Procurements process can include:

- ◆ Listings of prospective and prequalified sellers; and
- ◆ Information on relevant experience with sellers, both good and bad.

12.3 CONTROL PROCUREMENTS

Control Procurements is the process of managing procurement relationships; monitoring contract performance, and making changes and corrections as appropriate; and closing out contracts. The key benefit of this process is that it ensures that both the seller's and buyer's performance meet the project's requirements according to the terms of the legal agreement. This process is performed throughout the project as needed. The inputs, tools and techniques, and outputs of this process are depicted in Figure 12-6. Figure 12-7 depicts the data flow diagram of the process.

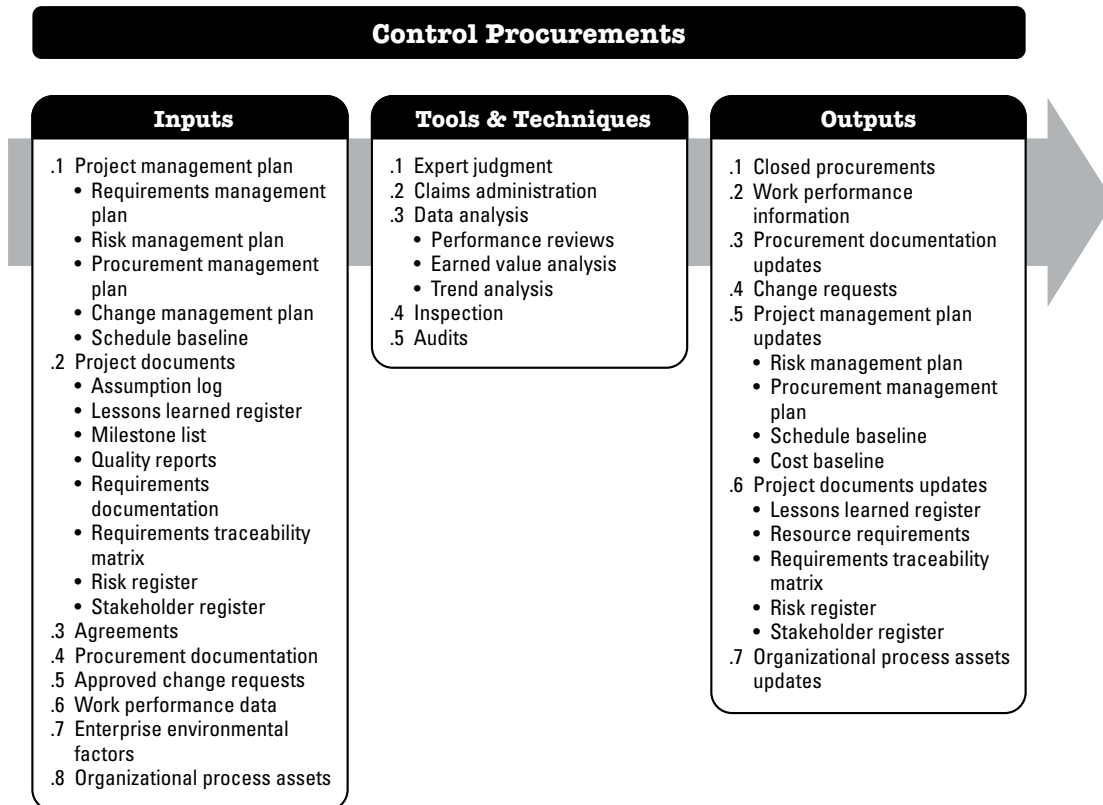

Figure 12-6. Control Procurements: Inputs, Tools & Techniques, and Outputs

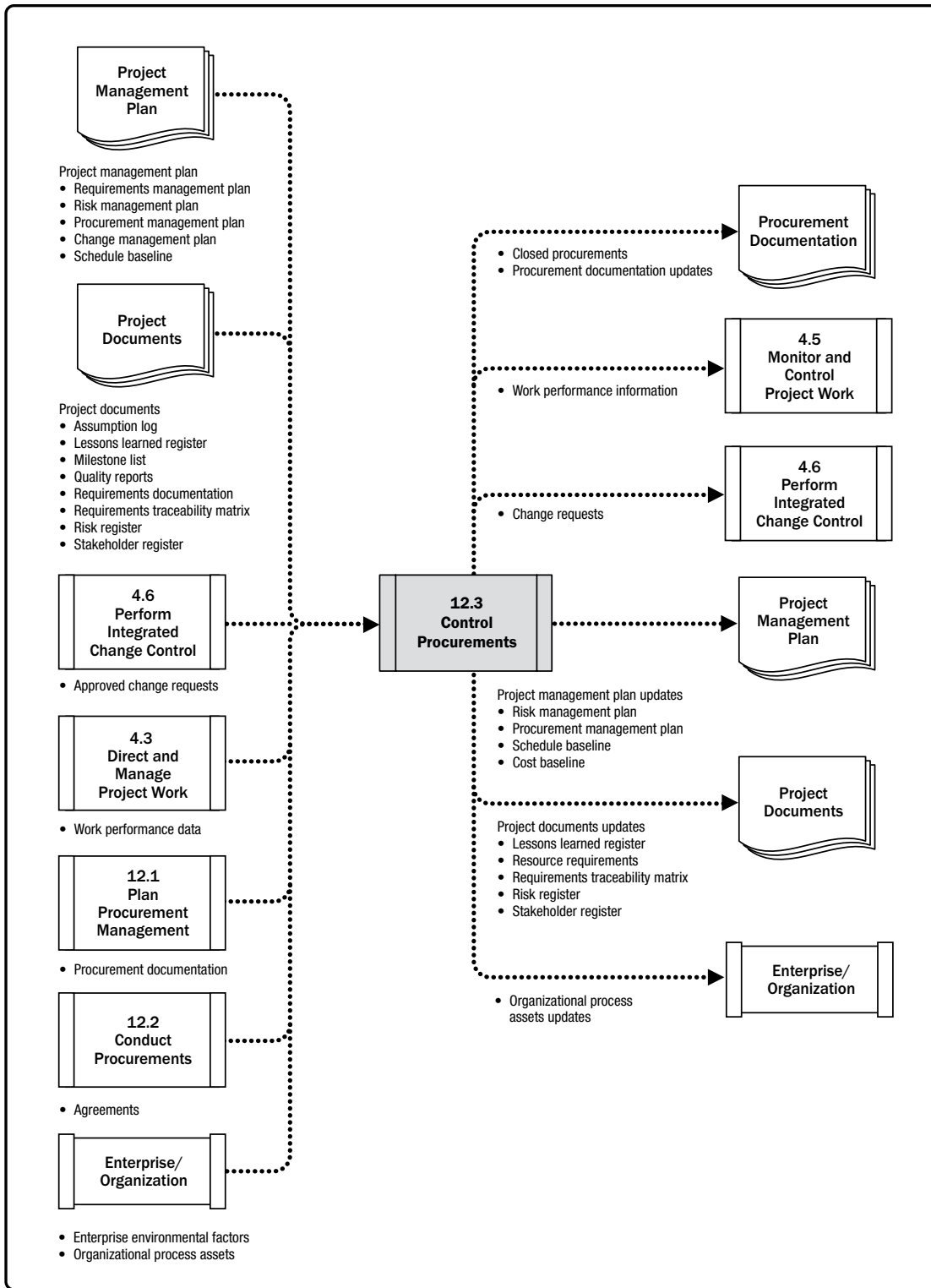

Figure 12-7. Control Procurements: Data Flow Diagram

Both the buyer and the seller administer the procurement contract for similar purposes. Each is required to ensure that both parties meet their contractual obligations and that their own legal rights are protected. The legal nature of the relationship makes it imperative that the project management team is aware of the implications of actions taken when controlling any procurement. On larger projects with multiple providers, a key aspect of contract administration is managing communication among the various providers.

Because of the legal aspect, many organizations treat contract administration as an organizational function that is separate from the project. While a procurement administrator may be on the project team, this individual typically reports to a supervisor from a different department.

Control Procurements includes application of the appropriate project management processes to the contractual relationship(s) and integration of the outputs from these processes into the overall management of the project. This integration often occurs at multiple levels when there are multiple sellers and multiple products, services, or results involved.

Administrative activities may include:

- ◆ Collection of data and managing project records, including maintenance of detailed records of physical and financial performance and establishment of measurable procurement performance indicators;
- ◆ Refinement of procurement plans and schedules;
- ◆ Set up for gathering, analyzing, and reporting procurement-related project data and preparation of periodic reports to the organization;
- ◆ Monitoring the procurement environment so that implementation can be facilitated or adjustments made; and
- ◆ Payment of invoices.

The quality of the controls, including the independence and credibility of procurement audits, is critical to the reliability of the procurement system. The organization's code of ethics, its legal counsel, and external legal advisory arrangements including any ongoing anti-corruption initiatives can contribute to proper procurement controls.

Control Procurements has a financial management component that involves monitoring payments to the seller. This ensures that payment terms defined within the contract are met and that compensation is linked to the seller's progress as defined in the contract. A principal concern when making payments is to ensure there is a close relationship of payments made to the work accomplished. A contract that requires payments linked to project output and deliverables rather than inputs such as labor hours has better controls.

Agreements can be amended at any time prior to contract closure by mutual consent, in accordance with the change control terms of the agreement. Such amendments are typically captured in writing.

12.3.1 CONTROL PROCUREMENTS: INPUTS

12.3.1.1 PROJECT MANAGEMENT PLAN

Described in Section 4.2.3.1. Project management plan components include but are not limited to:

- ◆ **Requirements management plan.** Described in Section 5.1.3.2. The requirements management plan describes how contractor requirements will be analyzed, documented, and managed.
- ◆ **Risk management plan.** Described in Section 11.1.3.1. The risk management plan describes how risk activities created by sellers will be structured and performed for the project.
- ◆ **Procurement management plan.** Described in Section 12.1.3.2. The procurement management plan contains the activities to be performed during the Control Procurement process.
- ◆ **Change management plan.** Described in Section 4.2.3.1. The change management plan contains information about how seller-created changes will be processed.
- ◆ **Schedule baseline.** Described in Section 6.5.3.1. If there are slippages created by sellers that impact overall project performance, the schedule may need to be updated and approved to reflect the current expectations.

12.3.1.2 PROJECT DOCUMENTS

Project documents that can be considered as inputs to this process include but are not limited to:

- ◆ **Assumption log.** Described in Section 4.1.3.2. The assumption log documents the assumptions that have been made during the procurement process.
- ◆ **Lessons learned register.** Described in Section 4.4.3.1. Lessons learned earlier in the project can be applied further along in the project to improve contractor performance and the procurement process.
- ◆ **Milestone list.** Described in Section 6.2.3.3. This list of major milestones shows when the sellers are expected to deliver their results.
- ◆ **Quality reports.** Described in Section 8.2.3.1. The quality reports can identify seller processes, procedures, or products that are out of compliance.
- ◆ **Requirements documentation.** Described in Section 5.2.3.1. Requirements documentation may include:
 - Technical requirements the seller is required to satisfy, and
 - Requirements with contractual and legal implications that may include health, safety, security, performance, environmental, insurance, intellectual property rights, equal employment opportunity, licenses, permits, and other nontechnical requirements.

- ◆ **Requirements traceability matrix.** Described in Section 5.2.3.2. The requirements traceability matrix links product requirements from their origin to the deliverables that satisfy them.
- ◆ **Risk register.** Described in Section 11.2.3.1. Each approved seller comes with its own unique set of risks, depending on the seller's organization, the duration of the contract, the external environment, the project delivery method, the type of contracting vehicle chosen, and the final agreed-upon price.
- ◆ **Stakeholder register.** Described in Section 13.1.3.1. The stakeholder register includes information about identified stakeholders, including contracted team members, selected sellers, contracting officers, and other stakeholders who are involved in procurements.

12.3.1.3 AGREEMENTS

Described in Section 12.2.3.2. Agreements are understandings between parties, including understanding of the duties of each party. The relevant agreements are reviewed to verify terms and conditions are met.

12.3.1.4 PROCUREMENT DOCUMENTATION

Procurement documentation contains complete supporting records for administration of the procurement processes. Procurement documentation includes the statement of work, payment information, contractor work performance information, plans, drawings, and other correspondence.

12.3.1.5 APPROVED CHANGE REQUESTS

Described in Section 4.6.3.1. Approved change requests can include modifications to the terms and conditions of the contract, including the procurement statement of work (SOW), pricing, and descriptions of the products, services, or results to be provided. All procurement-related changes are formally documented in writing and approved before being implemented through the Control Procurements process. In complex projects and programs, change requests may come from sellers involved with the project that can influence other involved sellers. The project should have the capability of identifying, communicating, and resolving changes that impact the work of multiple sellers.

12.3.1.6 WORK PERFORMANCE DATA

Described in Section 4.3.3.2. Work performance data contains seller data on project status such as technical performance; activities that have started, are in progress, or have completed; and costs that have been incurred or committed. Work performance data can also include information on the seller invoices that have been paid.

12.3.1.7 ENTERPRISE ENVIRONMENTAL FACTORS

The enterprise environmental factors that can influence the Control Procurements process include but are not limited to:

- ◆ Contract change control system,
- ◆ Marketplace conditions,
- ◆ Financial management and accounts payable system, and
- ◆ Buying organization's code of ethics.

12.3.1.8 ORGANIZATIONAL PROCESS ASSETS

The organizational process assets that can influence the Control Procurements process include but are not limited to, procurement policies.

12.3.2 CONTROL PROCUREMENTS: TOOLS AND TECHNIQUES

12.3.2.1 EXPERT JUDGMENT

Described in Section 4.1.2.1 Expertise should be considered from individuals or groups with specialized knowledge or training in the following topics:

- ◆ Relevant functional areas such as finance, engineering, design, development, supply chain management, etc.;
- ◆ Laws, regulations, and compliance requirements; and
- ◆ Claims administration.

12.3.2.2 CLAIMS ADMINISTRATION

Contested changes and potential constructive changes are those requested changes where the buyer and seller cannot reach an agreement on compensation for the change or cannot agree that a change has occurred. These contested changes are called claims. When they cannot be resolved, they become disputes and finally appeals. Claims are documented, processed, monitored, and managed throughout the contract life cycle, usually in accordance with the terms of the contract. If the parties themselves do not resolve a claim, it may have to be handled in accordance with alternative dispute resolution (ADR) typically following procedures established in the contract. Settlement of all claims and disputes through negotiation is the preferred method.

12.3.2.3 DATA ANALYSIS

Data analysis techniques that can be used to monitor and control procurements include but are not limited to:

- ◆ **Performance Reviews.** Performance reviews for contracts measure, compare, and analyze quality, resource, schedule, and cost performance against the agreement. This includes identifying work packages that are ahead or behind schedule, over or under budget, or have resource or quality issues.
- ◆ **Earned Value Analysis (EVA).** Described in Section 7.4.2.2. Schedule and cost variances along with schedule and cost performance indexes are calculated to determine the degree of variance from target.
- ◆ **Trend Analysis.** Described in Section 4.5.2.2. Trend analysis can develop a forecast estimate at completion (EAC) for cost performance to see if performance is improving or deteriorating. See 7.4.2.2 for more detail on EAC methods.

12.3.2.4 INSPECTION

An inspection is a structured review of the work being performed by the contractor. This may involve a simple review of the deliverables or an actual physical review of the work itself. On a construction/engineering/infrastructure project, inspections involve walkthroughs of the site by both the buyer and the contractor to ensure a mutual understanding of the work in progress.

12.3.2.5 AUDITS

Audits are described in Section 8.2.2.5. Audits are a structured review of the procurement process. Rights and obligations related to audits should be described in the procurement contract. Resulting audit observations should be brought to the attention of the buyer's project manager and the seller's project manager for adjustments to the project, when necessary.

12.3.3 CONTROL PROCUREMENTS: OUTPUTS

12.3.3.1 CLOSED PROCUREMENTS

The buyer, usually through its authorized procurement administrator, provides the seller with formal written notice that the contract has been completed. Requirements for formal procurement closure are usually defined in the terms and conditions of the contract and are included in the procurement management plan. Typically, all deliverables should have been provided on time and meet technical and quality requirements, there should be no outstanding claims or invoices, and all final payments should have been made. The project management team should have approved all deliverables prior to closure.

12.3.3.2 WORK PERFORMANCE INFORMATION

Described in Section 4.5.1.3. Work performance information includes information on how a seller is performing by comparing the deliverables received, the technical performance achieved, and the costs incurred and accepted against the SOW budget for the work performed.

12.3.3.3 PROCUREMENT DOCUMENTATION UPDATES

Procurement documentation that may be updated includes the contract with all supporting schedules, requested unapproved contract changes, and approved change requests. Procurement documentation also includes any seller-developed technical documentation and other work performance information such as deliverables, seller performance reports and warranties, financial documents including invoices and payment records, and the results of contract-related inspections.

12.3.3.4 CHANGE REQUESTS

Described in Section 4.3.3.4. Change requests to the project management plan, its subsidiary plans, and other components such as the cost baseline, schedule baseline, and procurement management plan, may result from the Control Procurements process. Change requests are processed for review and disposition through the Perform Integrated Change Control process (Section 4.6).

Requested but unresolved changes can include direction provided by the buyer or actions taken by the seller, which the other party considers a constructive change to the contract. Since any of these constructive changes may be disputed by one party and can lead to a claim against the other party, such changes are uniquely identified and documented by project correspondence.

12.3.3.5 PROJECT MANAGEMENT PLAN UPDATES

Any change to the project management plan goes through the organization's change control process via a change request. Components that may require a change request for the project management plan include but are not limited to:

- ◆ **Risk management plan.** Described in Section 11.1.3.1. Each agreement and seller has its own set of risks that may require updates to the risk management plan. If significant unexpected risks occur during the execution of the contract, the risk management plan may require updating. Specific risks are incorporated into the risk register.
- ◆ **Procurement management plan.** Described in Section 12.1.3.1. The procurement management plan contains the activities to be undertaken during the procurement process. Updates may be required depending on the results of the performance of the sellers during execution of the work.
- ◆ **Schedule baseline.** Described in Section 6.5.3.1. If there are significant schedule changes created by sellers that impact overall project schedule performance, the baseline schedule may need to be updated and approved to reflect the current expectations. The buyer should be aware of any cascading impacts of schedule delays created by a seller that impact other sellers.
- ◆ **Cost baseline.** Described in Section 7.3.3.1. Contractor and material costs can change frequently during the delivery of a project. These changes can occur because of fluctuating materials and labor prices created by the external economic environment and need to be incorporated into the cost baseline.

12.3.3.6 PROJECT DOCUMENTS UPDATES

Project documents that may be updated as a result of carrying out this process include but are not limited to:

- ◆ **Lessons learned register.** Described in Section 4.4.3.1. The lessons learned register can be updated with techniques that were effective in maintaining the scope, schedule, and cost of the procured items. Where variances occurred, the register should show the corrective actions that were used to respond to variances and how effective those actions were. If there are any claims, information should be documented to avoid recurrences. Additional information on how to improve the procurement process can also be recorded.
- ◆ **Resource requirements.** Described in Section 9.2.3.1. As the work progresses by the contractors, there may be changes to the resource requirements resulting from work being done that is not in accordance with the planned work schedule.

- ◆ **Requirements traceability matrix.** Described in Section 5.2.3.2. The requirements traceability matrix is updated with information on requirements that have been satisfied.
- ◆ **Risk register.** Described in Section 11.2.3.1. Each approved seller comes with its own unique set of risks, depending on the seller's organization, the duration of the contract, the external environment, the project delivery method, the type of contracting vehicle chosen, and the final agreed-upon price. Changes are made to the risk register during the execution of the project, as early risks may no longer be applicable and new risks occur.
- ◆ **Stakeholder register.** Described in Section 13.1.3.1. As the work progresses through the execution phase, the contractors and suppliers may change. These changes should be reflected in the stakeholder register.

12.3.3.7 ORGANIZATIONAL PROCESS ASSETS UPDATES

Organizational process assets that can be updated as a result of the Control Procurements process include but are not limited to:

- ◆ **Payment schedules and requests.** All payments should be made in accordance with the procurement contract terms and conditions.
- ◆ **Seller performance evaluation documentation.** Seller performance evaluation documentation is prepared by the buyer and documents the seller's ability to continue to perform work on the current contract, indicates whether the seller can be allowed to perform work on future projects, or rates how well the seller is performing the project work or has performed in the past.
- ◆ **Prequalified seller lists updates.** Prequalified seller lists are lists of potential sellers who are previously qualified (approved). These lists will be updated according to the Procurement Control process outcomes because sellers could be disqualified and removed from the lists based on poor performance.
- ◆ **Lessons learned repository.** Lessons learned should be archived in the lessons learned repository to improve procurements on future projects. At the end of a contract, the actual results of the procurement are compared with the projected results in the original procurement management plan. These lessons learned state whether the project objectives were achieved and, if not, provides the reasons they were not.
- ◆ **Procurement file.** A complete set of indexed contract documentation, including the closed contract, is prepared for inclusion with the final project files.



13

PROJECT STAKEHOLDER MANAGEMENT

Project Stakeholder Management includes the processes required to identify the people, groups, or organizations that could impact or be impacted by the project, to analyze stakeholder expectations and their impact on the project, and to develop appropriate management strategies for effectively engaging stakeholders in project decisions and execution. The processes support the work of the project team to analyze stakeholder expectations, assess the degree to which they impact or are impacted by the project, and develop strategies to effectively engage stakeholders in support of project decisions and the planning and execution of the work of the project.

The Project Stakeholder Management processes are:

13.1 Identify Stakeholders—The process of identifying project stakeholders regularly and analyzing and documenting relevant information regarding their interests, involvement, interdependencies, influence, and potential impact on project success.

13.2 Plan Stakeholder Engagement—The process of developing approaches to involve project stakeholders based on their needs, expectation, interests, and potential impact on the project.

13.3 Manage Stakeholder Engagement—The process of communicating and working with stakeholders to meet their needs and expectations, address issues, and foster appropriate stakeholder engagement involvement.

13.4 Monitor Stakeholder Engagement—The process of monitoring project stakeholder relationships and tailoring strategies for engaging stakeholders through the modification of engagement strategies and plans.

Figure 13-1 provides an overview of the Project Stakeholder Management processes. The Project Stakeholder Management processes are presented as discrete processes with defined interfaces while, in practice, they overlap and interact in ways that cannot be completely detailed in the *PMBOK® Guide*.

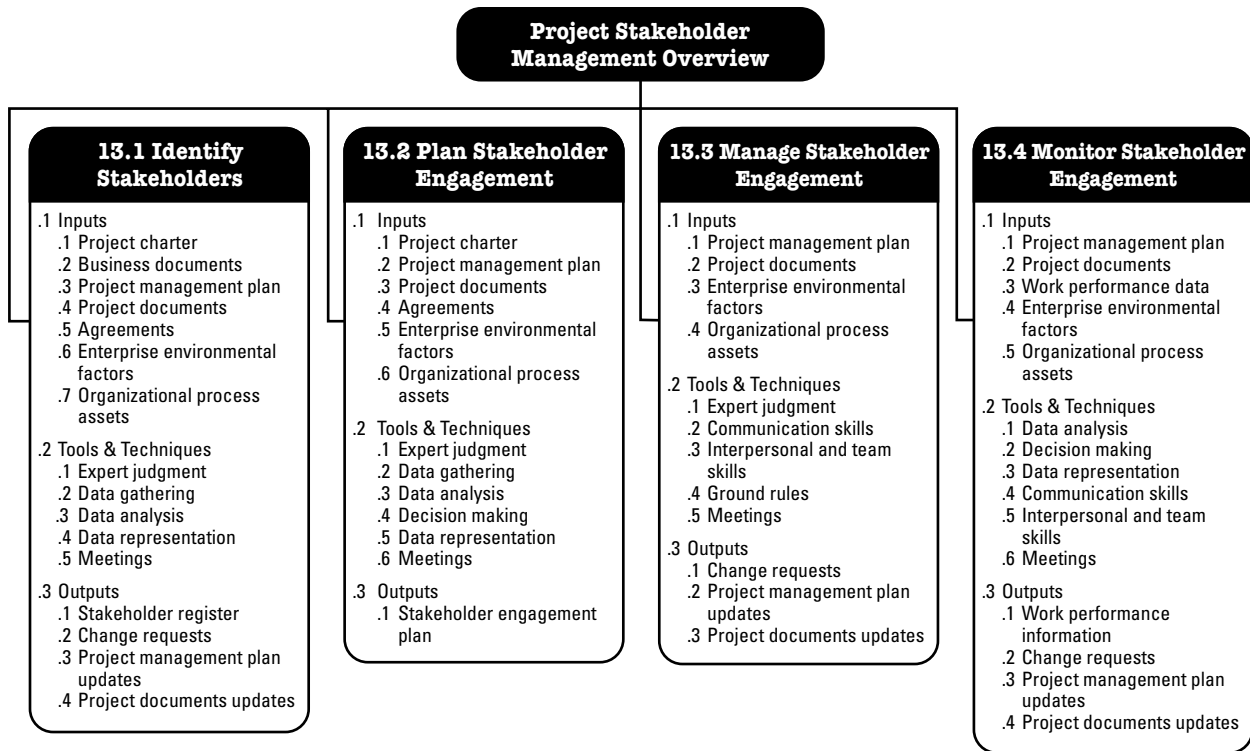

Figure 13-1. Project Stakeholder Management Overview

KEY CONCEPTS FOR PROJECT STAKEHOLDER MANAGEMENT

Every project has stakeholders who are impacted by or can impact the project in a positive or negative way. Some stakeholders may have a limited ability to influence the project's work or outcomes; others may have significant influence on the project and its expected outcomes. Academic research and analyses of high-profile project disasters highlight the importance of a structured approach to the identification, prioritization, and engagement of all stakeholders. The ability of the project manager and team to correctly identify and engage all stakeholders in an appropriate way can mean the difference between project success and failure. To increase the chances of success, the process of stakeholder identification and engagement should commence as soon as possible after the project charter has been approved, the project manager has been assigned and the team begins to form.

Stakeholder satisfaction should be identified and managed as a project objective. The key to effective stakeholder engagement is a focus on continuous communication with all stakeholders, including team members, to understand their needs and expectations, address issues as they occur, manage conflicting interests, and foster appropriate stakeholder engagement in project decisions and activities.

The process of identifying and engaging stakeholders for the benefit of the project is iterative. Although the processes in Project Stakeholder Management are described only once, the activities of identification, prioritization, and engagement should be reviewed and updated routinely, and at least at the following times when:

- ◆ The project moves through different phases in its life cycle,
- ◆ Current stakeholders are no longer involved in the work of the project or new stakeholders become members of the project's stakeholder community, or
- ◆ There are significant changes in the organization or the wider stakeholder community.

TRENDS AND EMERGING PRACTICES IN PROJECT STAKEHOLDER ENGAGEMENT

Broader definitions of stakeholders are being developed that expand the traditional categories of employees, suppliers, and shareholders to include groups such as regulators, lobby groups, environmentalists, financial organizations, the media, and those who simply believe they are stakeholders—they perceive that they will be affected by the work or outcomes of the project.

Trends and emerging practices for Project Stakeholder Management include but are not limited to:

- ◆ Identifying all stakeholders, not just a limited set;
- ◆ Ensuring that all team members are involved in stakeholder engagement activities;
- ◆ Reviewing the stakeholder community regularly, often in parallel with reviews of individual project risks;
- ◆ Consulting with stakeholders who are most affected by the work or outcomes of the project through the concept of co-creation. Co-creation places greater emphasis on including affected stakeholders in the team as partners; and
- ◆ Capturing the value of effective stakeholder engagement, both positive and negative. Positive value can be based on the consideration of benefits derived from higher levels of active support from stakeholders, particularly powerful stakeholders. Negative value can be derived by measuring the true costs of not engaging stakeholders effectively, leading to product recalls or loss of organizational or project reputation.

TAILORING CONSIDERATIONS

Because each project is unique, the project manager may need to tailor the way Project Stakeholder Management processes are applied. Considerations for tailoring include but are not limited to:

- ◆ **Stakeholder diversity.** How many stakeholders are there? How diverse is the culture within the stakeholder community?
- ◆ **Complexity of stakeholder relationships.** How complex are the relationships within the stakeholder community? The more networks a stakeholder or stakeholder group participates in, the more complex the networks of information and misinformation the stakeholder may receive.
- ◆ **Communication technology.** What communication technology is available? What support mechanisms are in place to ensure that best value is achieved from the technology?

CONSIDERATIONS FOR AGILE/ADAPTIVE ENVIRONMENTS

Projects experiencing a high degree of change require active engagement and participation with project stakeholders. To facilitate timely, productive discussion and decision making, adaptive teams engage with stakeholders directly rather than going through layers of management. Often the client, user, and developer exchange information in a dynamic co-creative process that leads to more stakeholder involvement and higher satisfaction. Regular interactions with the stakeholder community throughout the project mitigate risk, build trust, and support adjustments earlier in the project cycle, thus reducing costs and increasing the likelihood of success for the project.

In order to accelerate the sharing of information within and across the organization, agile methods promote aggressive transparency. The intent of inviting any stakeholders to project meetings and reviews or posting project artifacts in public spaces is to surface as quickly as possible any misalignment, dependency, or other issue related to the changing project.

13.1 IDENTIFY STAKEHOLDERS

Identify Stakeholders is the process of identifying project stakeholders regularly and analyzing and documenting relevant information regarding their interests, involvement, interdependencies, influence, and potential impact on project success. The key benefit of this process is that it enables the project team to identify the appropriate focus for engagement of each stakeholder or group of stakeholders. This process is performed periodically throughout the project as needed. The inputs, tools and techniques, and outputs of the process are depicted in Figure 13-2. Figure 13-3 depicts the data flow diagram for the process.

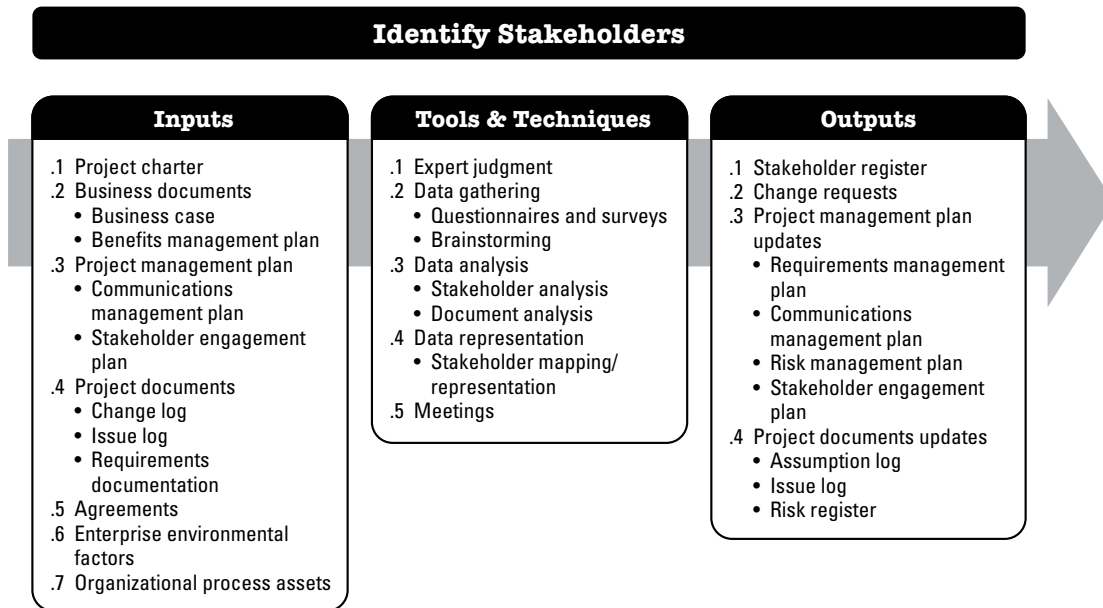

Figure 13-2. Identify Stakeholders: Inputs, Tools & Techniques, and Outputs

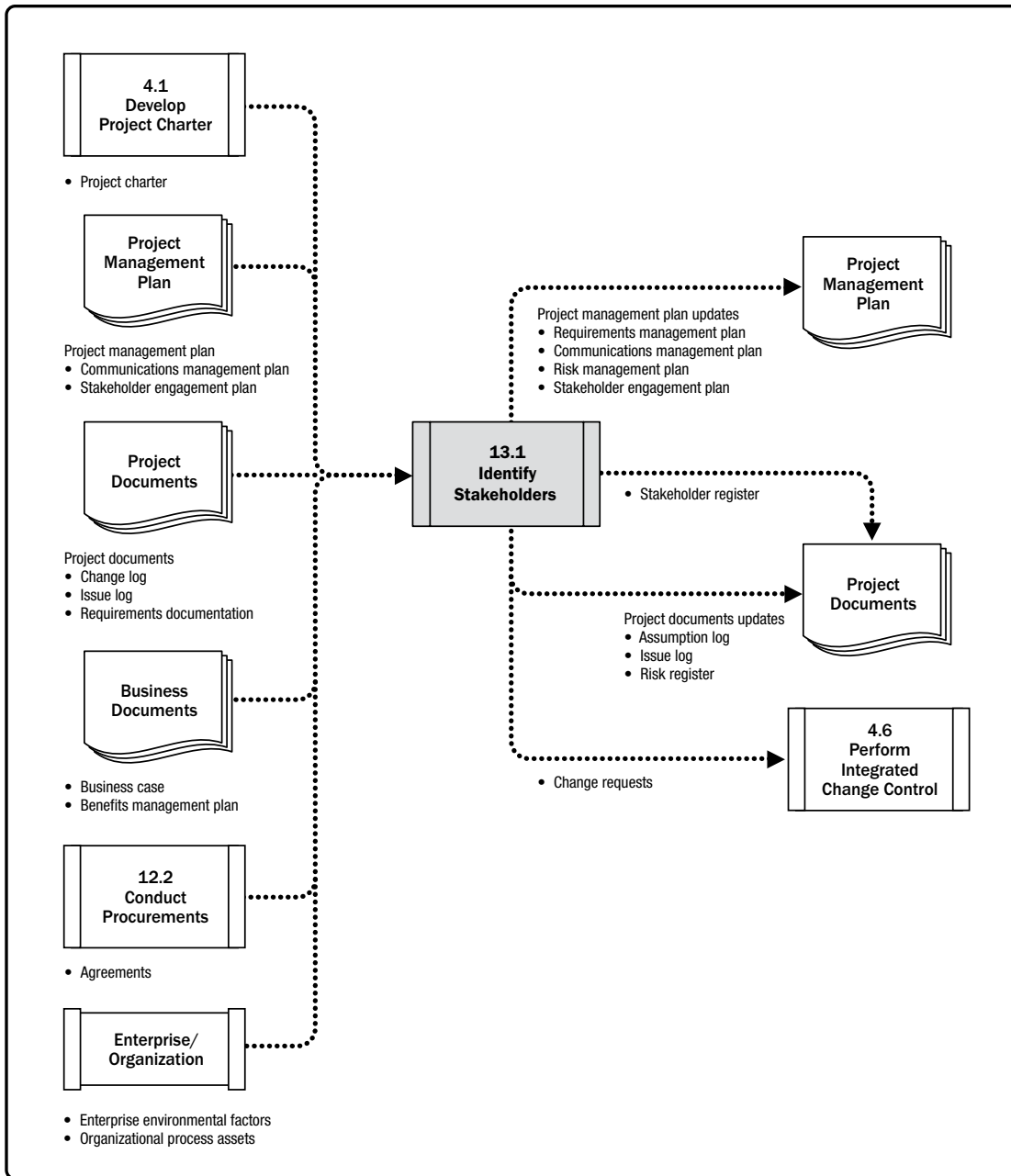

Figure 13-3. Identify Stakeholders: Data Flow Diagram

This process frequently occurs for the first time in a project either prior to or at the same time the project charter is developed and approved. It is repeated as necessary, but should be performed at the start of each phase and when a significant change in the project or the organization occurs. Each time the identification process is repeated, the project management plan components and project documents should be consulted to identify relevant project stakeholders.

13.1.1 IDENTIFY STAKEHOLDERS: INPUTS

13.1.1.1 PROJECT CHARTER

Described in Section 4.1.3.1. The project charter identifies the key stakeholder list. It may also contain information about the responsibilities of the stakeholders.

13.1.1.2 BUSINESS DOCUMENTS

In the first iteration of the Identify Stakeholders process, the business case and the benefits management plan are sources of information about the project's stakeholders.

- ◆ **Business case.** Described in Section 1.2.6.1. The business case identifies the project objectives and identifies an initial list of stakeholders affected by the project.
- ◆ **Benefits management plan.** Described in Section 1.2.6.2. The benefits management plan describes the expected plan for realizing the benefits claimed in the business case. It may identify the individuals and groups that will benefit from the delivery of the outcomes of the project and are thus considered as stakeholders.

13.1.1.3 PROJECT MANAGEMENT PLAN

Described in Section 4.2.3.1. The project management plan is not available when initially identifying stakeholders; however, once it has been developed, project management plan components include but are not limited to:

- ◆ **Communications management plan.** Described in Section 10.1.3.1. Communications and stakeholder engagement are strongly linked. Information included in the communications management plan is a source of knowledge about the project's stakeholders.
- ◆ **Stakeholder engagement plan.** Described in Section 13.2.3.1. The stakeholder engagement plan identifies the management strategies and actions required to effectively engage stakeholders.



13.1.1.4 PROJECT DOCUMENTS

It is unlikely that any project documents will be an input for the initial stakeholder identification. However, stakeholder identification occurs throughout the project. Once the project is past the startup phase, more documents become available and are used throughout the project. Project documents that can be considered as inputs for this process include but are not limited to:

- ◆ **Change log.** Described in Section 4.6.3.3. The change log may introduce a new stakeholder or change the nature of an existing stakeholder's relationship to the project.
- ◆ **Issue log.** Described in Section 4.3.3.3. The issue log records issues that may introduce new stakeholders to the project or change the type of participation of existing stakeholders.
- ◆ **Requirements documentation.** Described in Section 5.2.3.1. Requirements can provide information on potential stakeholders.

13.1.1.5 AGREEMENTS

Described in Section 12.2.3.2. The parties of an agreement are project stakeholders. The agreement can contain references to additional stakeholders.

13.1.1.6 ENTERPRISE ENVIRONMENTAL FACTORS

The enterprise environmental factors that can influence the Identify Stakeholders process include but are not limited to:

- ◆ Organizational culture, political climate, and governance framework;
- ◆ Government or industry standards (regulations, product standards, and codes of conduct);
- ◆ Global, regional, or local trends and practices or habits; and
- ◆ Geographic distribution of facilities and resources.

13.1.1.7 ORGANIZATIONAL PROCESS ASSETS

The organizational process assets that can influence the Identify Stakeholders process include but are not limited to:

- ◆ Stakeholder register templates and instructions,
- ◆ Stakeholder registers from previous projects, and
- ◆ Lessons learned repository with information about the preferences, actions, and involvement of stakeholders.

13.1.2 IDENTIFY STAKEHOLDERS: TOOLS AND TECHNIQUES

13.1.2.1 EXPERT JUDGMENT

Described in Section 4.1.2.1. Expertise should be considered from individuals or groups with specialized knowledge or training in the following topics:

- ◆ Understanding the politics and power structures in the organization,
- ◆ Knowledge of the environment and culture of the organization and other affected organizations including customers and the wider environment,
- ◆ Knowledge of the industry or type of project deliverable, and
- ◆ Knowledge of individual team member contributions and expertise.

13.1.2.2 DATA GATHERING

Data-gathering techniques that can be used for this process include but are not limited to:

- ◆ **Questionnaires and surveys.** Described in Section 5.2.2.2. Questionnaires and surveys can include one-on-one reviews, focus group sessions, or other mass information collection techniques.
- ◆ **Brainstorming.** Described in Section 4.1.2.2. Brainstorming as used to identify stakeholders can include both brainstorming and brain writing.
 - *Brainstorming.* A general data-gathering and creativity technique that elicits input from groups such as team members or subject matter experts.
 - *Brain writing.* A refinement of brainstorming that allows individual participants time to consider the question(s) individually before the group creativity session is held. The information can be gathered in face-to-face groups or using virtual environments supported by technology.



13.1.2.3 DATA ANALYSIS

Data analysis techniques that can be used for this process include but are not limited to:

- ◆ **Stakeholder analysis.** Stakeholder analysis results in a list of stakeholders and relevant information such as their positions in the organization, roles on the project, “stakes,” expectations, attitudes (their levels of support for the project), and their interest in information about the project. Stakeholders’ stakes can include but are not limited to a combination of:
 - *Interest.* A person or group can be affected by a decision related to the project or its outcomes.
 - *Rights (legal or moral rights).* Legal rights, such as occupational health and safety, may be defined in the legislation framework of a country. Moral rights may involve concepts of protection of historical sites or environmental sustainability.
 - *Ownership.* A person or group has a legal title to an asset or a property.
 - *Knowledge.* Specialist knowledge, which can benefit the project through more effective delivery of project objectives, organizational outcomes, or knowledge of the power structures of the organization.
 - *Contribution.* Provision of funds or other resources, including human resources, or providing support for the project in more intangible ways, such as advocacy in the form of promoting the objectives of the project or acting as a buffer between the project and the power structures of the organization and its politics.
- ◆ **Document analysis.** Described in Section 5.2.2.3. Assessing the available project documentation and lessons learned from previous projects to identify stakeholders and other supporting information.

13.1.2.4 DATA REPRESENTATION

A data representation technique that may be used in this process includes but is not limited to stakeholder mapping/representation. Stakeholder mapping and representation is a method of categorizing stakeholders using various methods. Categorizing stakeholders assists the team in building relationships with the identified project stakeholders. Common methods include:

- ◆ **Power/interest grid, power/influence grid, or impact/influence grid.** Each of these techniques supports a grouping of stakeholders according to their level of authority (power), level of concern about the project’s outcomes (interest), ability to influence the outcomes of the project (influence), or ability to cause changes to the project’s planning or execution. These classification models are useful for small projects or for projects with simple relationships between stakeholders and the project, or within the stakeholder community itself.

- ◆ **Stakeholder cube.** This is a refinement of the grid models previously mentioned. This model combines the grid elements into a three-dimensional model that can be useful to project managers and teams in identifying and engaging their stakeholder community. It provides a model with multiple dimensions that improves the depiction of the stakeholder community as a multidimensional entity and assists with the development of communication strategies.
- ◆ **Saliency model.** Describes classes of stakeholders based on assessments of their power (level of authority or ability to influence the outcomes of the project), urgency (need for immediate attention, either time-constrained or relating to the stakeholders' high stake in the outcome), and legitimacy (their involvement is appropriate). There is an adaptation of the saliency model that substitutes proximity for legitimacy (applying to the team and measuring their level of involvement with the work of the project). The saliency model is useful for large complex communities of stakeholders or where there are complex networks of relationships within the community. It is also useful in determining the relative importance of the identified stakeholders.
- ◆ **Directions of influence.** Classifies stakeholders according to their influence on the work of the project or the project team itself. Stakeholders can be classified in the following ways:
 - *Upward* (senior management of the performing organization or customer organization, sponsor, and steering committee),
 - *Downward* (the team or specialists contributing knowledge or skills in a temporary capacity),
 - *Outward* (stakeholder groups and their representatives outside the project team, such as suppliers, government departments, the public, end-users, and regulators), or
 - *Sideward* (the peers of the project manager, such as other project managers or middle managers who are in competition for scarce project resources or who collaborate with the project manager in sharing resources or information).
- ◆ **Prioritization.** Prioritizing stakeholders may be necessary for projects with a large number of stakeholders, where the membership of the stakeholder community is changing frequently, or when the relationships between stakeholders and the project team or within the stakeholder community are complex.

13.1.2.5 MEETINGS

Meetings are used to develop an understanding of significant project stakeholders. They can take the form of facilitation workshops, small group guided discussions, and virtual groups using electronics or social media technologies to share ideas and analyze data.

13.1.3 IDENTIFY STAKEHOLDERS: OUTPUTS

13.1.3.1 STAKEHOLDER REGISTER

The main output of the Identify Stakeholders process is the stakeholder register. This document contains information about identified stakeholders that includes but is not limited to:

- ◆ **Identification information.** Name, organizational position, location and contact details, and role on the project.
- ◆ **Assessment information.** Major requirements, expectations, potential for influencing project outcomes, and the phase of the project life cycle where the stakeholder has the most influence or impact.
- ◆ **Stakeholder classification.** Internal/external, impact/influence/power/interest, upward/downward/outward/sideward, or any other classification model chosen by the project manager.

13.1.3.2 CHANGE REQUESTS

Described in Section 4.3.3.4. During the first iteration of identifying stakeholders, there will not be any change requests. As stakeholder identification continues throughout the project, new stakeholders, or new information about stakeholders, may result in a change request to the product, project management plan, or project documents.

Change requests are processed for review and disposition through the Perform Integrated Change Control (Section 4.6) process.

13.1.3.3 PROJECT MANAGEMENT PLAN UPDATES

When stakeholders are identified at the very beginning of a project, there will not be updates to the project management plan. As the project progresses, any change to the project management plan goes through the organization's change control process via a change request. Components that may require a change request for the project management plan include but are not limited to:

- ◆ **Requirements management plan.** Described in Section 5.1.1.2. Newly identified stakeholders can impact how requirements activities will be planned, tracked, and reported.
- ◆ **Communications management plan.** Described in Section 10.1.3.1. Stakeholder communication requirements and agreed-upon communications strategies are recorded in the communications management plan.
- ◆ **Risk management plan.** Described in Section 11.1.3.1. Where stakeholder communication requirements and agreed-upon communications strategies affect the approach to managing risk on the project, this is reflected in the risk management plan.
- ◆ **Stakeholder engagement plan.** Described in Section 13.2.3.1. Agreed-upon communications strategies for identified stakeholders are recorded in the stakeholder engagement plan.

13.1.3.4 PROJECT DOCUMENTS UPDATES

Project documents that may be updated as a result of carrying out this process include but are not limited to:

- ◆ **Assumption log.** Described in Section 4.1.3.2. Much of the information about the relative power, interest, and engagement of stakeholders is based on assumptions. This information is entered into the assumption log. Additionally, any constraints associated with interacting with specific stakeholders are entered as well.
- ◆ **Issue log.** Described in Section 4.3.3.3. New issues raised as a result of this process are recorded in the issue log.
- ◆ **Risk register.** Described in Section 11.2.3.1. New risks identified during this process are recorded in the risk register and managed using the risk management processes.



13.2 PLAN STAKEHOLDER ENGAGEMENT

Plan Stakeholder Engagement is the process of developing approaches to involve project stakeholders based on their needs, expectations, interests, and potential impact on the project. The key benefit is that it provides an actionable plan to interact effectively with stakeholders. This process is performed periodically throughout the project as needed.

The inputs, tools and techniques, and outputs of the process are depicted in Figure 13-4. Figure 13-5 depicts the data flow diagram for the process.

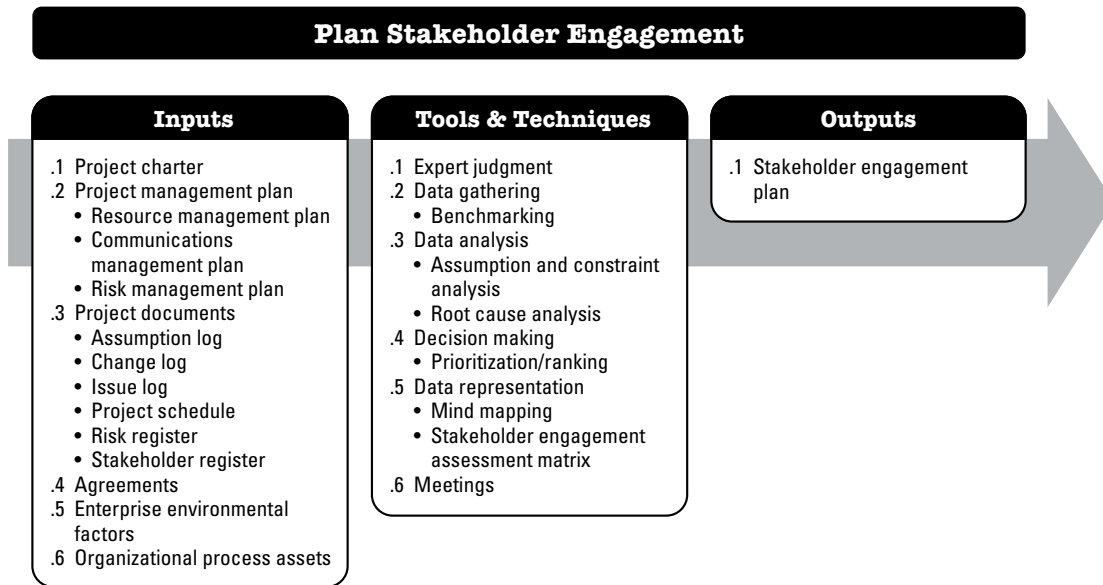

Figure 13-4. Plan Stakeholder Engagement: Inputs, Tools & Techniques, and Outputs

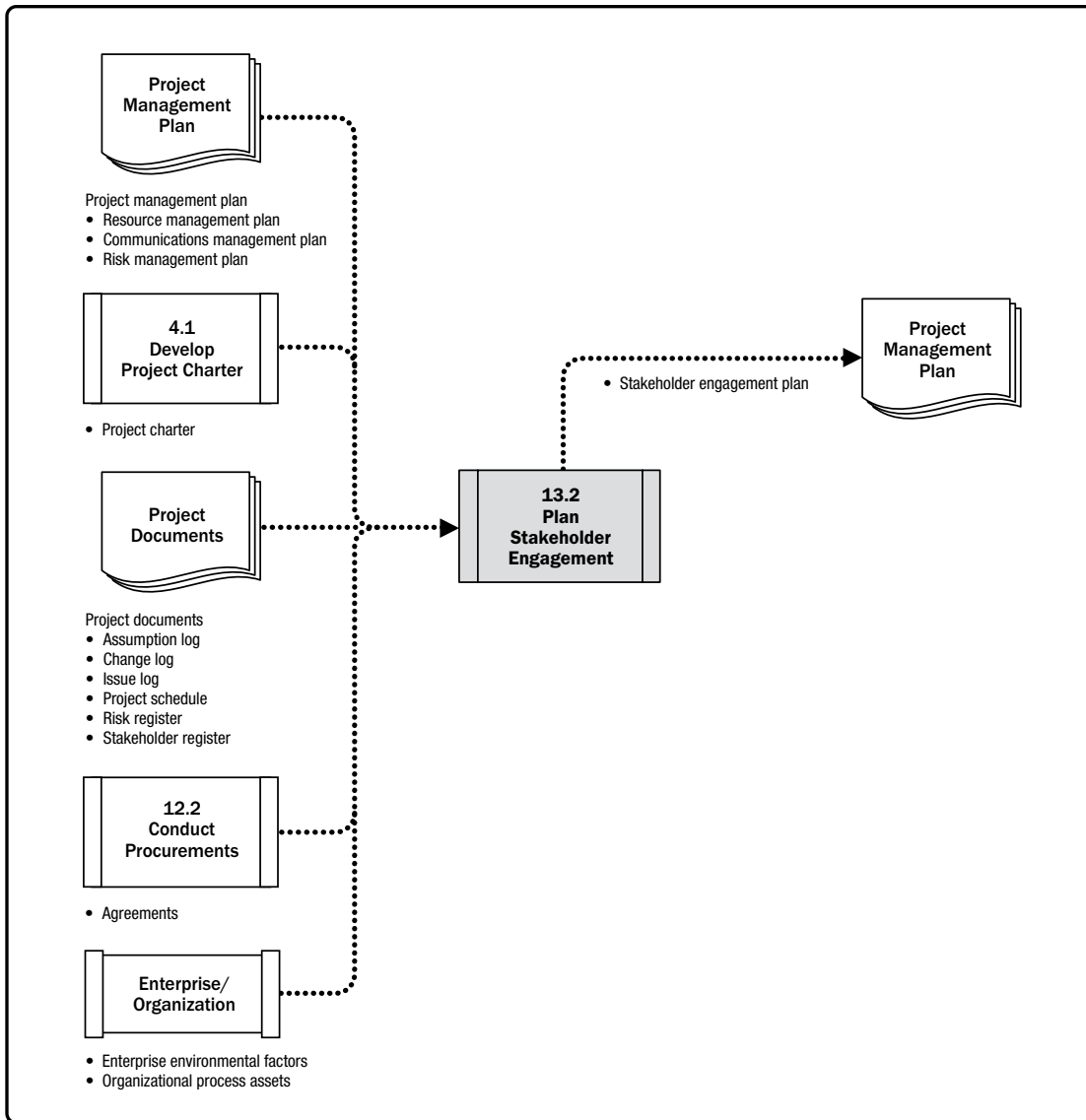

Figure 13-5. Plan Stakeholder Engagement: Data Flow Diagram

An effective plan that recognizes the diverse information needs of the project's stakeholders is developed early in the project life cycle and is reviewed and updated regularly as the stakeholder community changes. The first version of the stakeholder engagement plan is developed after the initial stakeholder community has been identified by the Identify Stakeholder process. The stakeholder engagement plan is updated regularly to reflect changes to the stakeholder community. Typical trigger situations requiring updates to the plan include but are not limited to:

- ◆ When it is the start of a new phase of the project;
- ◆ When there are changes to the organization structure or within the industry;
- ◆ When new individuals or groups become stakeholders, current stakeholders are no longer part of the stakeholder community, or the importance of particular stakeholders to the project's success changes; and
- ◆ When outputs of other project process areas, such as change management, risk management, or issue management, require a review of stakeholder engagement strategies.

The results of these adjustments may be changes to the relative importance of the stakeholders who have been identified.

13.2.1 PLAN STAKEHOLDER ENGAGEMENT: INPUTS

13.2.1.1 PROJECT CHARTER

Described in Section 4.1.3.1. The project charter contains information on the project purpose, objectives, and success criteria that can be taken into consideration when planning how to engage stakeholders.

13.2.1.2 PROJECT MANAGEMENT PLAN

Described in Section 4.2.3.1. Project management plan components include but are not limited to:

- ◆ **Resource management plan.** Described in Section 9.1.3.1. The resource management plan may contain information regarding roles and responsibilities of the team and other stakeholders listed in the stakeholder register.
- ◆ **Communications management plan.** Described in Section 10.1.3.1. The communications strategies for stakeholder management and their implementation plans are both inputs to, and recipients of, information from processes in Project Stakeholder Management.
- ◆ **Risk management plan.** Described in Section 11.1.3.1. The risk management plan may contain risk thresholds or risk attitudes that can assist in the selection of the optimal stakeholder engagement strategy mix.

13.2.1.3 PROJECT DOCUMENTS

Project documents that can be considered as inputs for this process, especially after initial planning has taken place, include but are not limited to:

- ◆ **Assumption log.** Described in Section 4.1.3.2. The assumption log contains information about assumptions and constraints and may be linked to specific stakeholders.
- ◆ **Change log.** Described in Section 4.6.3.3. The change log contains changes to the original scope of the project. It usually links to specific stakeholders because they fall into categories of requesting certain changes, making decisions about change requests, or being impacted by the implementation of approved changes.
- ◆ **Issue log.** Described in Section 4.3.3.3. Managing and resolving issues contained in the issue log will require additional communications with the stakeholders affected.
- ◆ **Project schedule.** Described in Section 6.5.3.2. The schedule contains activities that may be linked to specific stakeholders as owners or executors.
- ◆ **Risk register.** Described in Section 11.2.3.1. The risk register contains the identified risks of the project and usually links them to the specific stakeholders as either risk owners or as subject to risk impact.
- ◆ **Stakeholder register.** Described in Section 13.1.3.1. The stakeholder register provides the list of project stakeholders including additional classification data and other information.

13.2.1.4 AGREEMENTS

Described in Section 12.2.3.2. When planning for the engagement of contractors and suppliers, coordination usually involves working with the procurement/contracting group in the organization to ensure contractors and suppliers are effectively managed.

13.2.1.5 ENTERPRISE ENVIRONMENTAL FACTORS

The enterprise environmental factors that can influence Plan Stakeholder Engagement include but are not limited to:

- ◆ Organizational culture, political climate, and governance framework;
- ◆ Personnel administration policies;
- ◆ Stakeholder risk appetites;
- ◆ Established communication channels;
- ◆ Global regional or local trends, practices, or habits; and
- ◆ Geographic distribution of facilities and resources.

13.2.1.6 ORGANIZATIONAL PROCESS ASSETS

The organizational process assets that can influence the Plan Stakeholder Engagement process include but are not limited to:

- ◆ Corporate policies and procedures for social media, ethics, and security;
- ◆ Corporate policies and procedures for issue, risk, change, and data management;
- ◆ Organizational communication requirements;
- ◆ Standardized guidelines for development, exchange, storage, and retrieval of information;
- ◆ Lessons learned repository with information about the preferences, actions, and involvement of stakeholders; and
- ◆ Software tools needed to support effective stakeholder engagement.

13.2.2 PLAN STAKEHOLDER ENGAGEMENT: TOOLS AND TECHNIQUES

13.2.2.1 EXPERT JUDGMENT

Described in Section 4.1.2.1. Expertise should be considered from individuals or groups with specialized knowledge or training in the following topics:

- ◆ Politics and power structures in the organization and outside the organization,
- ◆ Environment and culture of the organization and outside the organization,
- ◆ Analytical and assessment techniques to be used for stakeholder engagement processes,
- ◆ Communication means and strategies, and
- ◆ Knowledge from previous projects of the characteristics of stakeholders and stakeholder groups and organizations involved in the current project that may have been involved in previous similar projects.

13.2.2.2 DATA GATHERING

A data-gathering technique that can be used for this process includes but is not limited to benchmarking. Described in Section 8.1.2.2. The results of stakeholder analysis are compared with information from other organizations or other projects that are considered to be world class.

13.2.2.3 DATA ANALYSIS

Data analysis techniques that can be used for this process include but are not limited to:

- ◆ **Assumption and constraint analysis.** Described in Section 11.2.2.3. Analysis of current assumptions and constraints may be conducted in order to tailor appropriate engagement strategies.
- ◆ **Root cause analysis.** Described in Section 8.2.2.2. Root cause analysis identifies underlying reasons for the level of support of project stakeholders in order to select the appropriate strategy to improve their level of engagement.

13.2.2.4 DECISION MAKING

Decision-making techniques that can be used for this process include but are not limited to prioritization/ranking. Stakeholder requirements need to be prioritized and ranked, as do the stakeholders themselves. Stakeholders with the most interest and the highest influence are often prioritized at the top of the list.

13.2.2.5 DATA REPRESENTATION

Data representation techniques that may be used in this process include but are not limited to:

- ◆ **Mind mapping.** Described in Section 5.2.2.3. Mind mapping is used to visually organize information about stakeholders and their relationship to each other and the organization.
- ◆ **Stakeholder engagement assessment matrix.** A stakeholder engagement assessment matrix supports comparison between the current engagement levels of stakeholders and the desired engagement levels required for successful project delivery. One way to classify the engagement level of stakeholders is shown in Figure 13-6. The engagement level of stakeholders can be classified as follows:
 - *Unaware.* Unaware of the project and potential impacts.
 - *Resistant.* Aware of the project and potential impacts but resistant to any changes that may occur as a result of the work or outcomes of the project. These stakeholders will be unsupportive of the work or outcomes of the project.
 - *Neutral.* Aware of the project, but neither supportive nor unsupportive.
 - *Supportive.* Aware of the project and potential impacts and supportive of the work and its outcomes.
 - *Leading.* Aware of the project and potential impacts and actively engaged in ensuring that the project is a success.

In Figure 13-6, C represents the current engagement level of each stakeholder and D indicates the level that the project team has assessed as essential to ensure project success (desired). The gap between current and desired for each stakeholder will direct the level of communications necessary to effectively engage the stakeholder. The closing of this gap between current and desired is an essential element of monitoring stakeholder engagement.

Stakeholder	Unaware	Resistant	Neutral	Supportive	Leading
Stakeholder 1	C			D	
Stakeholder 2			C	D	
Stakeholder 3				D C	

Figure 13-6. Stakeholder Engagement Assessment Matrix

13.2.2.6 MEETINGS

Meetings are used to discuss and analyze the input data of the stakeholder engagement planning process and to develop a sound stakeholder engagement plan.

13.2.3 PLAN STAKEHOLDER ENGAGEMENT: OUTPUTS

13.2.3.1 STAKEHOLDER ENGAGEMENT PLAN

The stakeholder engagement plan is a component of the project management plan that identifies the strategies and actions required to promote productive involvement of stakeholders in decision making and execution. It can be formal or informal and highly detailed or broadly framed, based on the needs of the project and the expectations of stakeholders.

The stakeholder engagement plan may include but is not limited to specific strategies or approaches for engaging with individuals or groups of stakeholders.

13.3 MANAGE STAKEHOLDER ENGAGEMENT

Manage Stakeholder Engagement is the process of communicating and working with stakeholders to meet their needs and expectations, address issues, and foster appropriate stakeholder involvement. The key benefit of this process is that it allows the project manager to increase support and minimize resistance from stakeholders. This process is performed throughout the project. The inputs, tools and techniques, and outputs of the process are depicted in Figure 13-7. Figure 13-8 depicts the data flow diagram for the process.

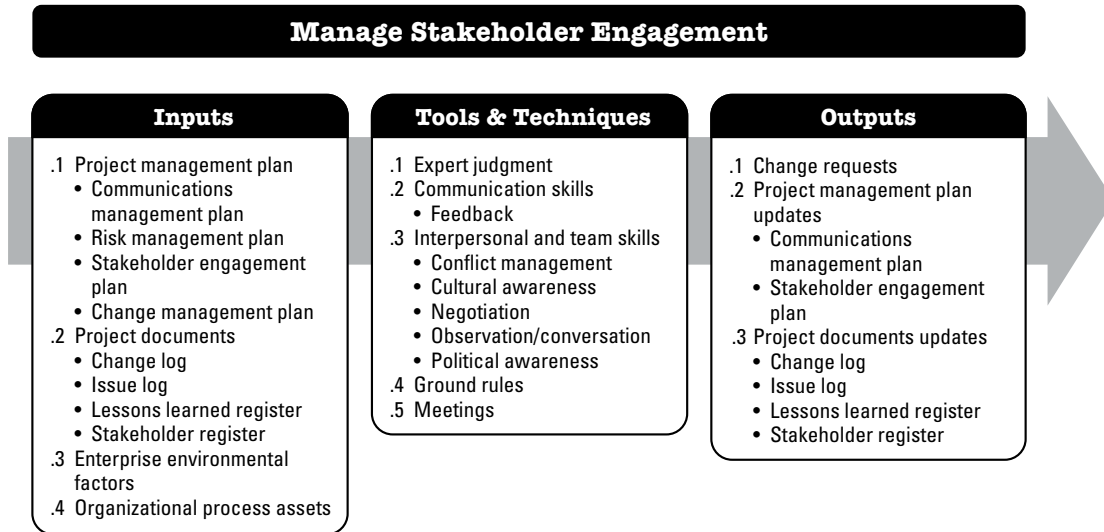

Figure 13-7. Manage Stakeholder Engagement: Inputs, Tools & Techniques, and Outputs

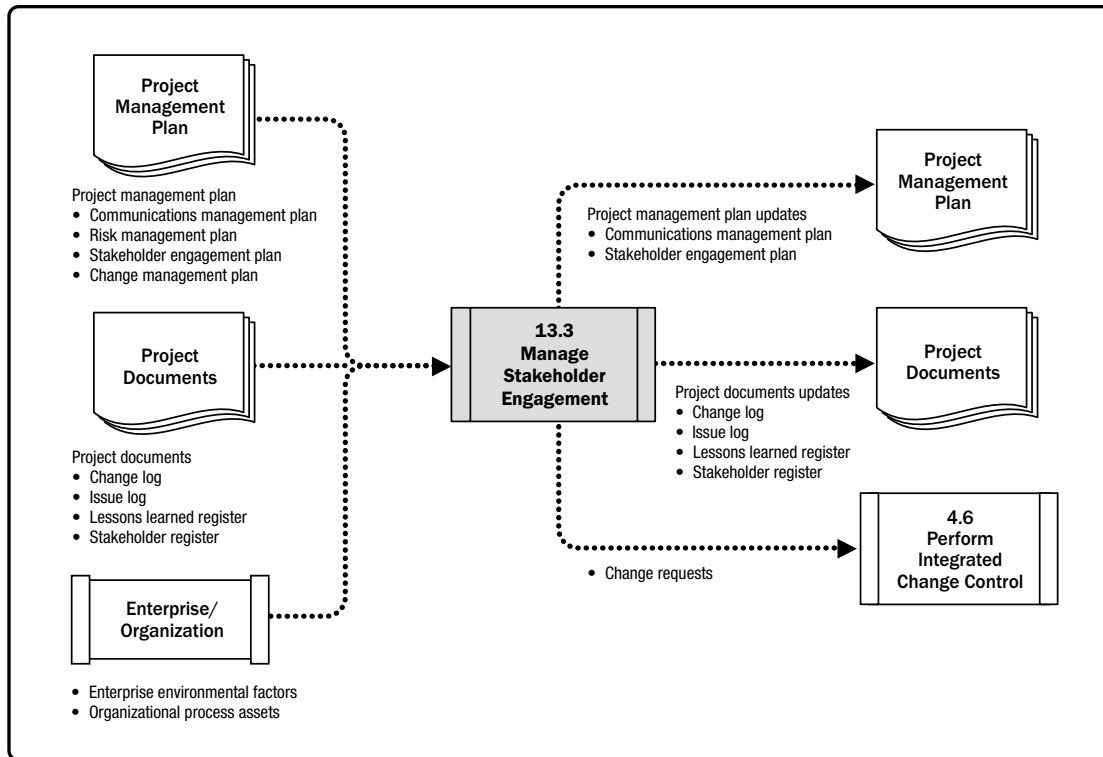

Figure 13-8. Manage Stakeholder Engagement: Data Flow Diagram

Manage Stakeholder Engagement involves activities such as:

- ◆ Engaging stakeholders at appropriate project stages to obtain, confirm, or maintain their continued commitment to the success of the project;
- ◆ Managing stakeholder expectations through negotiation and communication;
- ◆ Addressing any risks or potential concerns related to stakeholder management and anticipating future issues that may be raised by stakeholders; and
- ◆ Clarifying and resolving issues that have been identified.

Managing stakeholder engagement helps to ensure that stakeholders clearly understand the project goals, objectives, benefits, and risks for the project, as well as how their contribution will enhance project success.

13.3.1 MANAGE STAKEHOLDER ENGAGEMENT: INPUTS

13.3.1.1 PROJECT MANAGEMENT PLAN

Described in Section 4.2.3.1. Project management plan components include but are not limited to:

- ◆ **Communications management plan.** Described in Section 10.1.3.1. The communications management plan describes the methods, formats, and technologies used for stakeholder communication.
- ◆ **Risk management plan.** Described in Section 11.1.3.1. The risk management plan describes the risk categories, risk appetites, and reporting formats that can be used to manage stakeholder engagement.
- ◆ **Stakeholder engagement plan.** Described in Section 13.2.3.1. The stakeholder engagement plan provides guidance and information on managing stakeholder expectations.
- ◆ **Change management plan.** Described in Section 4.2.3.1. The change management plan describes the process for submitting, evaluating and implementing changes to the project.

13.3.1.2 PROJECT DOCUMENTS

Project documents that can be considered as inputs to this process include but are not limited to:

- ◆ **Change log.** Described in Section 4.6.3.3. Change requests and their status are documented in the change log and communicated to the appropriate stakeholders.
- ◆ **Issue log.** Described in Section 4.3.3.3. Any project or stakeholder concerns are documented in the issue log, as well as any assigned action items associated with managing the issue.
- ◆ **Lessons learned register.** Described in Section 4.4.3.1. Lessons learned earlier in the project with regard to managing stakeholder engagement can be applied to later phases in the project to improve the efficiency and effectiveness of this process.
- ◆ **Stakeholder register.** Described in Section 13.1.3.1. The stakeholder register provides the list of project stakeholders and any information needed to execute the stakeholder engagement plan.



13.3.1.3 ENTERPRISE ENVIRONMENTAL FACTORS

The enterprise environmental factors that can influence the Manage Stakeholder Engagement include but are not limited to:

- ◆ Organizational culture, political climate, and governance structure of the organization;
- ◆ Personnel administration policies;
- ◆ Stakeholder risk thresholds;
- ◆ Established communication channels;
- ◆ Global, regional, or local trends, practices, or habits; and
- ◆ Geographic distribution of facilities and resources.

13.3.1.4 ORGANIZATIONAL PROCESS ASSETS

The organizational process assets that can influence the Manage Stakeholder Engagement process include but are not limited to:

- ◆ Corporate policies and procedures for social media, ethics, and security;
- ◆ Corporate policies and procedures for issue, risk, change, and data management;
- ◆ Organizational communication requirements;
- ◆ Standardized guidelines for development, exchange, storage, and retrieval of information; and
- ◆ Historical information from previous similar projects.

13.3.2 MANAGE STAKEHOLDER ENGAGEMENT: TOOLS AND TECHNIQUES

13.3.2.1 EXPERT JUDGMENT

Described in Section 4.1.2.1. Expertise should be considered from individuals or groups with specialized knowledge or training in the following topics:

- ◆ Politics and power structures in the organization and outside the organization;
- ◆ Environment and culture of the organization and outside the organization;
- ◆ Analytical and assessment techniques to be used for stakeholder engagement processes;
- ◆ Communication methods and strategies;
- ◆ Characteristics of stakeholders, stakeholder groups, and organizations involved in the current project that may have been involved in previous projects; and
- ◆ Requirements management, vendor management, and change management.

13.3.2.2 COMMUNICATION SKILLS

The methods of communication identified for each stakeholder in the communications management plan are applied during stakeholder engagement management. The project management team uses feedback to assist in understanding stakeholder reaction to the various project management activities and key decisions. Feedback may be collected in the following ways, but not limited to:

- ◆ Conversations; both formal and informal,
- ◆ Issue identification and discussion,
- ◆ Meetings,
- ◆ Progress reporting, and
- ◆ Surveys.

13.3.2.3 INTERPERSONAL AND TEAM SKILLS

Interpersonal and team skills that can be used for this process include but are not limited to:

- ◆ **Conflict management.** Described in Section 9.5.2.1. The project manager should ensure that conflicts are resolved in a timely manner.
- ◆ **Cultural awareness.** Described in Section 10.1.2.6. Cultural awareness is used to help the project manager and team to communicate effectively by considering cultural differences and the requirements of stakeholders.
- ◆ **Negotiation.** Described in Section 12.2.2.5. Negotiation is used to achieve support or agreement that supports the work of the project or its outcomes and to resolve conflicts within the team or with other stakeholders.
- ◆ **Observation/conversation.** Described in Section 5.2.2.6. Observation/conversation is used to stay in touch with the work and attitudes of project team members and other stakeholders.
- ◆ **Political awareness.** Described in Section 10.1.2.6. Political awareness is achieved through understanding the power relationships within and around the project.

13.3.2.4 GROUND RULES

Ground rules, defined in the team charter set the expected behavior for project team members, as well as other stakeholders, with regard to stakeholder engagement.

13.3.2.5 MEETINGS

Described in Section 10.1.2.8. Meetings are used to discuss and address any issue or concern regarding stakeholder engagement. Types of meetings that are beneficial as part of this process include but are not limited to:

- ◆ Decision making,
- ◆ Issue resolution,
- ◆ Lessons learned and retrospectives,
- ◆ Project kick-off,
- ◆ Sprint planning, and
- ◆ Status updates.

13.3.3 MANAGE STAKEHOLDER ENGAGEMENT: OUTPUTS

13.3.3.1 CHANGE REQUESTS

Described in Section 4.3.3.4. As a result of managing stakeholder engagement, changes to the project scope or product scope may emerge. All change requests are processed for review and disposition through the Perform Integrated Change Control process (Section 4.6).

13.3.3.2 PROJECT MANAGEMENT PLAN UPDATES

Any change to the project management plan goes through the organization's change control process via a change request. Components of the project management plan that may require a change request for the project management plan include but are not limited to:

- ◆ **Communications management plan.** Described in Section 10.1.3.1. The communications management plan is updated to reflect new or changed stakeholder requirements.
- ◆ **Stakeholder engagement plan.** Described in Section 13.2.3.1. The stakeholder engagement plan is updated to reflect new or changed management strategies required to effectively engage stakeholders.

13.3.3.3 PROJECT DOCUMENTS UPDATES

Project documents that may be updated as a result of carrying out this process include but are not limited to:

- ◆ **Change log.** Described in Section 4.6.3.3. The change log may be updated based on any change requests.
- ◆ **Issue log.** Described in Section 4.3.3.3. The issue log may be updated to reflect an update to, or the development of, an issue log entry.
- ◆ **Lessons learned register.** Described in Section 4.4.3.1. The lessons learned register is updated with effective or ineffective approaches to managing stakeholder engagement so that information can be used in the current project or future projects.
- ◆ **Stakeholder register.** Described in Section 13.1.3.1. The stakeholder register may be updated based on new information provided to stakeholders about resolved issues, approved changes, and general project status.



13.4 MONITOR STAKEHOLDER ENGAGEMENT

Monitor Stakeholder Engagement is the process of monitoring project stakeholder relationships and tailoring strategies for engaging stakeholders through modification of engagement strategies and plans. The key benefit of this process is that it maintains or increases the efficiency and effectiveness of stakeholder engagement activities as the project evolves and its environment changes. This process is performed throughout the project. The inputs, tools and techniques, and outputs of the process are depicted in Figure 13-9. Figure 13-10 depicts the data flow diagram for the process.

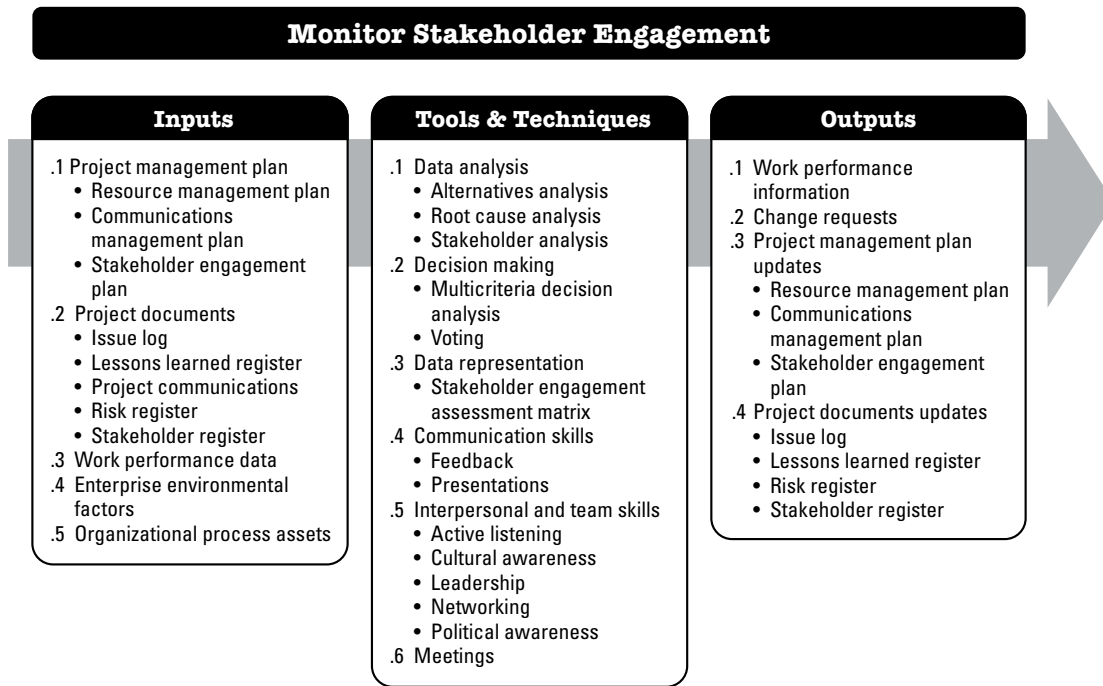

Figure 13-9. Monitor Stakeholder Engagement: Inputs, Tools & Techniques, and Outputs

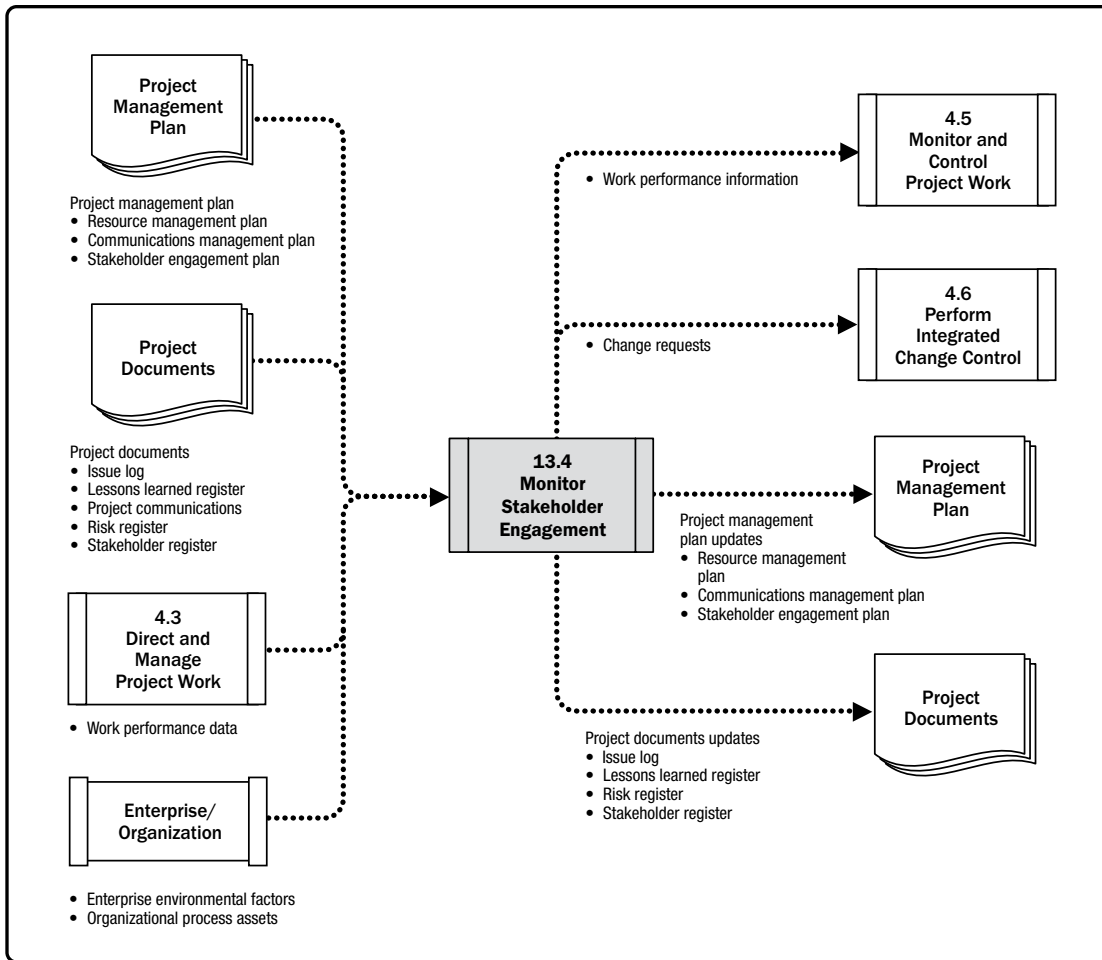

Figure 13-10. Monitor Stakeholder Engagement: Data Flow Diagram

13.4.1 MONITOR STAKEHOLDER ENGAGEMENT: INPUTS

13.4.1.1 PROJECT MANAGEMENT PLAN

Described in Section 4.2.3.1. Project management plan components include but are not limited to:

- ◆ **Resource management plan.** Described in Section 9.1.3.1. The resource management plan identifies the methods for team member management.
- ◆ **Communications management plan.** Described in Section 10.1.3.1. The communications management plan describes the plans and strategies for communication to the project's stakeholders.
- ◆ **Stakeholder engagement plan.** Described in Section 13.2.3.1. Defines the plan for managing stakeholder needs and expectations.

13.4.1.2 PROJECT DOCUMENTS

Project documents that can be considered as inputs for this process include but are not limited to:

- ◆ **Issue log.** Described in Section 4.3.3.3. The issue log documents all the known issues related to the project and stakeholders.
- ◆ **Lessons learned register.** Described in Section 4.4.3.1. Lessons learned earlier in the project can be applied in later phases of the project to improve the efficiency and effectiveness of engaging stakeholders.
- ◆ **Project communications.** Described in Section 10.2.3.1. These include the project communications that have been distributed to stakeholders as defined in the communications management plan and the stakeholder engagement plan.
- ◆ **Risk register.** Described in Section 11.2.3.1. The risk register contains the identified risks for the project, including those related to stakeholder engagement and interactions, their categorization, and list of potential responses.
- ◆ **Stakeholder register.** Described in Section 13.1.3.1. The stakeholder register contains stakeholder information that includes but is not limited to stakeholder identification, assessment, and classification.

13.4.1.3 WORK PERFORMANCE DATA

Described in Section 4.3.3.2. Work performance data contains data on project status such as which stakeholders are supportive of the project, and their level and type of engagement.

13.4.1.4 ENTERPRISE ENVIRONMENTAL FACTORS

The enterprise environmental factors that can influence the Monitor Stakeholder Engagement process include but are not limited to:

- ◆ Organizational culture, political climate, and governance framework;
- ◆ Personnel administration policies;
- ◆ Stakeholder risk thresholds;
- ◆ Established communication channels;
- ◆ Global, regional, or local trends, practices, or habits; and
- ◆ Geographic distribution of facilities and resources.

13.4.1.5 ORGANIZATIONAL PROCESS ASSETS

The organizational process assets that can influence the Monitor Stakeholder Engagement process include but are not limited to:

- ◆ Corporate policies and procedures for social media, ethics, and security;
- ◆ Corporate policies and procedures for issue, risk, change, and data management;
- ◆ Organizational communication requirement;
- ◆ Standardized guidelines for development, exchange, storage, and retrieval of information; and
- ◆ Historical information from previous projects.

13.4.2 MONITOR STAKEHOLDER ENGAGEMENT: TOOLS AND TECHNIQUES

13.4.2.1 DATA ANALYSIS

Data analysis techniques that can be used for this process include but are not limited to:

- ◆ **Alternatives analysis.** Described in Section 9.2.2.5. Alternatives analysis can be used to evaluate options to respond to variances in the desired results of stakeholder engagement.
- ◆ **Root cause analysis.** Described in Section 8.2.2.2. A root cause analysis can be used to determine the basic underlying reason that stakeholder engagement is not having the planned effect.
- ◆ **Stakeholder analysis.** Described in Section 13.1.2.3. The stakeholder analysis helps to determine the position of stakeholder groups and individuals at any particular time in the project.

13.4.2.2 DECISION MAKING

Decision-making techniques that can be used for this process include but are not limited to:

- ◆ **Multicriteria decision analysis.** Described in Section 8.1.2.4. Criteria for successful stakeholder engagement are prioritized and weighted to identify the most appropriate choice.
- ◆ **Voting.** Described in Section 5.2.2.4. Voting can be used to select the best response for a variance in stakeholder engagement.

13.4.2.3 DATA REPRESENTATION

A data representation technique used in this process includes but is not limited to a stakeholder engagement assessment matrix. Described in Section 13.2.2.3. The stakeholder engagement assessment matrix monitors stakeholder engagement through tracking changes in level of engagement for each stakeholder.

13.4.2.4 COMMUNICATION SKILLS

Communication techniques that can be used for this process include but are not limited to:

- ◆ **Feedback.** Described in Section 10.2.2.3. Feedback is used to ensure that the information to stakeholders is received and understood.
- ◆ **Presentations.** Described in Section 10.2.2.3. Presentations provide clear information to stakeholders.

13.4.2.5 INTERPERSONAL AND TEAM SKILLS

Interpersonal skills to that can be used for this process include but are not limited to:

- ◆ **Active listening.** Described in Section 10.2.2.6. Active listening is used to reduce misunderstandings and other miscommunication.
- ◆ **Cultural awareness.** Described in Section 10.1.2.6. Cultural awareness and cultural sensitivity help the project manager to plan communications based on the cultural differences and requirements of stakeholders and team members.
- ◆ **Leadership.** Described in Section 3.4.4. Successful stakeholder engagement requires strong leadership skills to communicate the vision and inspire stakeholders to support the work and outcomes of the project.
- ◆ **Networking.** Described in Section 10.2.2.6. Networking ensures access to information about levels of engagement of stakeholders.
- ◆ **Political awareness.** Described in Section 10.1.2.6. Political awareness is used to understand the strategies of the organization, understand who wields power and influence in this arena, and to develop an ability to communicate with these stakeholders.

13.4.2.6 MEETINGS

Types of meetings include status meetings, standup meetings, retrospectives, and any other meetings as agreed upon in the stakeholder engagement plan to monitor and assess stakeholder engagement levels. Meetings are no longer limited by face-to-face or voice-to-voice interactions. While face-to-face interactions are ideal, they can be expensive. Teleconferencing and technology bridge the gap and provide numerous ways to connect and conduct a meeting.

13.4.3 MONITOR STAKEHOLDER ENGAGEMENT: OUTPUTS

13.4.3.1 WORK PERFORMANCE INFORMATION

Described in Section 4.5.1.3. Work performance information includes information about the status of stakeholder engagement, such as the level of current project support and compared to the desired levels of engagement as defined in the stakeholder engagement assessment matrix, stakeholder cube, or other tool.

13.4.3.2 CHANGE REQUESTS

Described in Section 4.3.3.4. A change request may include corrective and preventive actions to improve the current level of stakeholder engagement. Change requests are processed for review and disposition through the Perform Integrated Change Control process (Section 4.6).

13.4.3.3 PROJECT MANAGEMENT PLAN UPDATES

Any change to the project management plan goes through the organization's change control process via a change request. Components of the project management plan that may require a change request include but are not limited to:

- ◆ **Resource management plan.** Described in Section 9.1.3.1. Team responsibilities for stakeholder engagement activities may need to be updated.
- ◆ **Communications management plan.** Described in Section 10.1.3.1. The project's communication strategies may need to be updated.
- ◆ **Stakeholder engagement plan.** Described in Section 13.2.3.1. Information about the project's stakeholder community may need to be updated.

13.4.3.4 PROJECT DOCUMENTS UPDATES

Project documents that may be updated as a result of carrying out this process include but are not limited to:

- ◆ **Issue log.** Described in Section 4.3.3.3. Information in the issue log indicates stakeholder attitudes and may need to be updated.
- ◆ **Lessons learned register.** Described in Section 4.3.3.1. The lessons learned register is updated with information on challenges and how they could have been avoided. It is also updated with approaches that worked well for engaging stakeholders optimally, and those that did not work well.
- ◆ **Risk register.** Described in Section 11.2.3.1. The risk register may need to be updated with responses to stakeholder risks.
- ◆ **Stakeholder register.** Described in Section 13.1.12-13.1. The stakeholder register is updated with information as a result of monitoring stakeholder engagement.

REFERENCES

- [1] Project Management Institute. 2017. *The Standard for Project Management*. Newtown Square, PA: Author.
- [2] Project Management Institute. 2013. *The Standard for Portfolio Management – Third Edition*. Newtown Square, PA: Author.
- [3] Project Management Institute. 2017. *The Standard for Program Management – Fourth Edition*. Newtown Square, PA: Author.
- [4] Project Management Institute. 2016. *The PMI Lexicon of Project Management Terms*. Available from <http://www.pmi.org/lexiconterms>
- [5] Project Management Institute. *Code of Ethics and Professional Conduct*. Available from <http://www.pmi.org/codeofethics>
- [6] Project Management Institute. 2013. *Managing Change in Organizations: A Practice Guide*. Newtown Square, PA: Author.
- [7] Project Management Institute. 2015. *Business Analysis for Practitioners: A Practice Guide*. Newtown Square, PA: Author.
- [8] Project Management Institute. 2014. *Implementing Organizational Project Management: A Practice Guide*. Newtown Square, PA: Author.
- [9] Project Management Institute. 2014. Project Management Institute Excellence in Practice-Research Collaboration, PMI-RI Standards Program: Making Sense of PPP Governance, December 19, 2014. Newtown Square, PA: Author
- [10] Project Management Institute. 2016. *Governance of Portfolios, Programs, and Projects: A Practice Guide*. Newtown Square, PA: Author.
- [11] Project Management Institute. (2013). *PMI's Pulse of the Profession® In-Depth Report: The Competitive Advantage of Effective Talent Management*. Available from <http://www.pmi.org>
- [12] Project Management Institute. 2015. White Paper, Complexity Management for Projects, Programmes, and Portfolios: An Engineering Systems Perspective, March 2015. Newtown Square, PA: Author.
- [13] Project Management Institute. 2014. *Navigating Complexity: A Practice Guide*. Newtown Square, PA: Author.
- [14] Project Management Institute. 2016. *Requirements Management: A Practice Guide*. Newtown Square, PA: Author.
- [15] Project Management Institute. 2006. *Practice Standard for Work Breakdown Structures (WBS)*. Newtown Square, PA: Author.
- [16] Project Management Institute. 2011. *Practice Standard for Scheduling – Second Edition*. Newtown Square, PA: Author.
- [17] Project Management Institute. 2011. *Practice Standard for Earned Value Management – Second Edition*
- [18] International Standards Organization. 2015. *ISO 9000:2015 Quality Management Systems—Fundamentals and Vocabulary*. Geneva: Author.



Part 2

The Standard for Project Management



1

INTRODUCTION

A standard is a document established by an authority, custom, or general consent as a model or example. This standard was developed using a process based on the concepts of consensus, openness, due process, and balance. This standard describes the processes considered to be good practice on most projects most of the time. These processes are organized by Process Group. It further defines key project management concepts including the relationship of project management to organizational strategy and objectives, governance, portfolio management, program management, the project environment, and project success. It also covers information on project life cycles, project stakeholders, and the role of the project manager. Section 1 discusses key concepts and provides contextual information about project management. Sections 2 through 6 provide definitions for each of the five Process Groups and describe the processes within those Process Groups. Sections 2 through 6 also describe the key benefits, inputs, and outputs for each project management process. This standard serves as the foundation and framework for *A Guide to the Project Management Body of Knowledge (PMBOK® Guide)*.¹ *PMBOK® Guide* expands on the information in this standard by providing a more in-depth description of the context, environment and influences on project management. In addition, the *PMBOK® Guide* provides descriptions of the project management process inputs and outputs, identifies tools and techniques, and discusses key concepts and emerging trends associated with each Knowledge Area.

¹ Project Management Institute. 2017. *A Guide to the Project Management Body of Knowledge (PMBOK® Guide)*. Newtown Square, PA: Author.

1.1 PROJECTS AND PROJECT MANAGEMENT

A project is a temporary endeavor undertaken to create a unique product, service, or result. The temporary nature of projects indicates a definite beginning and end. Temporary does not necessarily mean a project has a short duration. A project's end is reached when the objectives have been achieved or when the project is terminated because its objectives will not or cannot be met, or when the need for the project no longer exists. The decision to terminate a project requires approval and authorization by an appropriate authority.

Project management is the application of knowledge, skills, tools, and techniques to project activities to meet project requirements. Project management is accomplished through the appropriate application and integration of the project management processes identified for the project.

Managing a project typically includes but is not limited to:

- ◆ Identifying project requirements;
- ◆ Addressing the various needs, concerns, and expectations of stakeholders;
- ◆ Establishing and maintaining active communication with stakeholders;
- ◆ Managing resources; and
- ◆ Balancing the competing project constraints, which include but are not limited to:
 - Scope,
 - Schedule,
 - Cost,
 - Quality,
 - Resources, and
 - Risk.

Project circumstances will influence how each project management process is implemented and how the project constraints are prioritized.

1.2 RELATIONSHIPS AMONG PORTFOLIOS, PROGRAMS, AND PROJECTS

A portfolio is defined as projects, programs, subsidiary portfolios, and operations managed in a coordinated manner to achieve strategic objectives. Portfolio management is the centralized management of one or more portfolios to achieve strategic objectives. Portfolio management focuses on ensuring the portfolio is performing consistent with the organization's objectives and evaluating portfolio components to optimize resource allocation. Portfolios may include work that is operational in nature.

A program is defined as related projects, subsidiary programs, and program activities managed in a coordinated manner to obtain benefits not available from managing them individually. Programs include program related work outside the scope of the discrete projects in the program. Program management is the application of knowledge, skills, and principles to a program to achieve the program objectives and to obtain benefits and control not available by managing related program components individually. Programs may also include work that is operational in nature.

Program management supports organizational strategies by authorizing, changing, or terminating projects and managing their interdependencies. Managing project interdependencies may include, among other actions, the following:

- ◆ Resolving resource constraints and/or conflicts that affect components within the program;
- ◆ Aligning with the organization's strategies that impact and affect program goals and objectives
- ◆ Managing issues and employing change management within a shared governance structure;
- ◆ Addressing project and program risks that can impact one or more components; and
- ◆ Managing program benefits realization by effectively analyzing, sequencing and monitoring component interdependencies.

A project may be managed in three separate scenarios: as a stand-alone project (outside a portfolio or program); within a program; or within a portfolio. Project management has interactions with portfolio and program management when a project is within a portfolio or program.



Figure 1-1 illustrates a sample portfolio structure indicating relationships of the components, shared resources and stakeholders. The portfolio components are grouped together in order to facilitate the effective governance and management of that work and to achieve organizational strategies and priorities. Organizational and portfolio planning impact the components by means of prioritization based on risk, funding, and other considerations. This allows organizations to have an overall view of how the strategic goals are reflected in the portfolio; institute appropriate portfolio, program, and project governance; and authorize human, financial, or physical resources. These resources will be allocated based on expected performance and benefits. Figure 1-1 illustrates that organizational strategies and priorities are linked and have relationships between portfolios and programs, between portfolios and projects, and between programs and individual projects. These relationships are not always strictly hierarchical.

Organizational project management (OPM) is a strategy execution framework utilizing portfolio, program, and project management. It provides a framework that enables organizations to consistently and predictably deliver on organizational strategy, producing better performance, better results, and a sustainable competitive advantage.

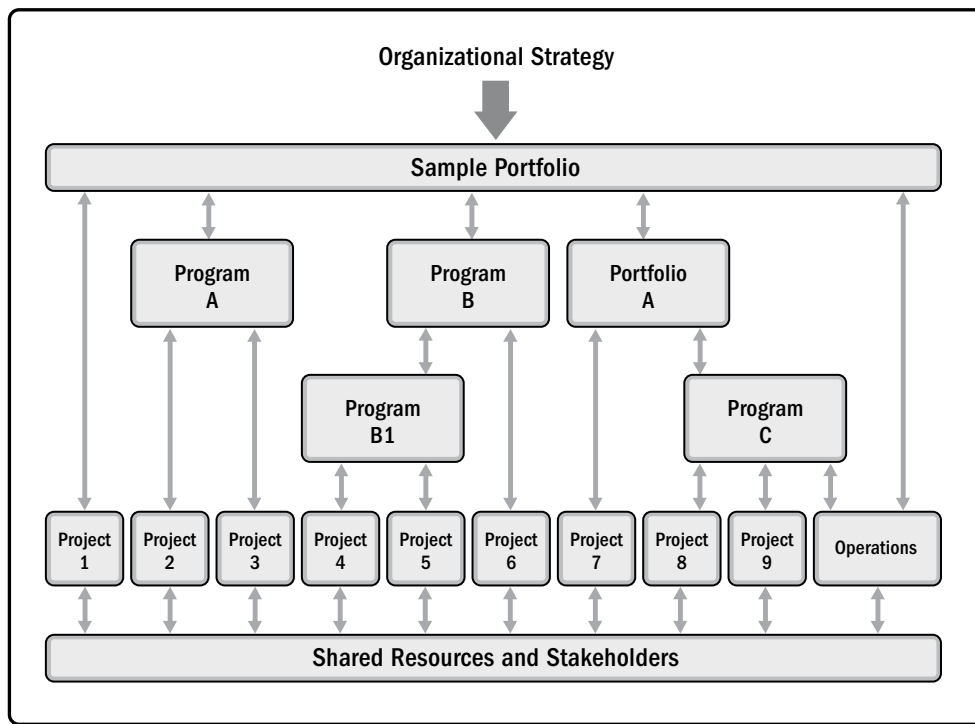

Figure 1-1. Example of Portfolio, Program, and Project Management Interfaces

1.3 LINKING ORGANIZATIONAL GOVERNANCE AND PROJECT GOVERNANCE

There are various types of governance including organizational governance; organizational project management (OPM) governance; and portfolio, program, and project governance. Organizational governance is a structured way to provide direction and control through policies, and processes, to meet strategic and operational goals. Organizational governance is typically conducted by a board of directors to ensure accountability, fairness, and transparency to its stakeholders. Organizational governance principles, decisions, and processes may influence and impact the governance of portfolios, programs, and projects in the following ways:

- ◆ Enforcing legal, regulatory, standards, and compliance requirements,
- ◆ Defining ethical, social, and environmental responsibilities, and
- ◆ Specifying operational, legal, and risk policies.

Project governance is the framework, functions, and processes that guide project management activities in order to create a unique product, service, or result to meet organizational, strategic, and operational goals. Governance at the project level includes:

- ◆ Guiding and overseeing the management of project work;
- ◆ Ensuring adherence to policies, standards, and guidelines;
- ◆ Establishing governance roles, responsibilities, and authorities;
- ◆ Decision-making regarding risk escalations, changes, and resources (e.g. team, financial, physical, facilities);
- ◆ Ensuring appropriate stakeholder engagement; and
- ◆ Monitoring performance.

The project governance framework provides the project stakeholders with structure, processes, roles, responsibilities, accountabilities, and decision-making models for managing the project. Elements of a project governance framework include but are not limited to principles or processes for:

- ◆ Stage gate or phase reviews;
- ◆ Identifying, escalating, and resolving risks and issues;
- ◆ Defining roles, responsibilities, and authorities;
- ◆ Process for project knowledge management and capturing lessons learned;
- ◆ Decision making, problem solving and escalating topics that are beyond the project manager's authority; and
- ◆ Reviewing and approving changes to project, and product changes that are beyond the authority of the project manager.

1.4 PROJECT SUCCESS AND BENEFITS MANAGEMENT

Projects are initiated to realize business opportunities that are aligned with an organization's strategic goals. Prior to initiating a project, a business case is often developed to outline the project objectives, the required investment, and financial and qualitative criteria for project success. The business case provides the basis to measure success and progress throughout the project life cycle by comparing the results with the objectives and the identified success criteria.

Projects are typically initiated as a result of one or more of the following strategic considerations:

- ◆ Market demand,
- ◆ Strategic opportunity/business need,
- ◆ Social need,
- ◆ Environmental consideration,
- ◆ Customer request,
- ◆ Technological advancement,
- ◆ Legal or regulatory requirement, and
- ◆ Existing or forecasted problem.

A benefits management plan describes how and when the benefits of the project will be delivered and how they will be measured. The benefits management plan may include the following:

- ◆ **Target benefits.** The expected tangible and intangible business value to be gained by the implementation of the product, service, or result.
- ◆ **Strategic alignment.** How the project benefits support and align with the business strategies of the organization.
- ◆ **Timeframe for realizing benefits.** Benefits by phase: short term, long term, and ongoing.
- ◆ **Benefits owner.** The accountable person or group that monitors, records, and reports realized benefits throughout the timeframe established in the plan.
- ◆ **Metrics.** The direct and indirect measurements used to show the benefits realized.
- ◆ **Risks.** Risks associated with achieving target benefits.

The success of the project is measured against the project objectives and success criteria. In many cases, the success of the product, service, or result is not known until sometime after the project is complete. For example, an increase in market share, a decrease in operating expenses, or the success of a new product may not be known when the project is transitioned to operations. In these circumstances, the project management office (PMO), portfolio steering committee, or some other business function within the organization should evaluate the success at a later date to determine if the outcomes met the business objectives.

Both the business case and the benefits management plan are developed prior to the project being initiated. Additionally, both documents are referenced after the project has been completed. Therefore, they are considered business documents rather than project documents or components of the project management plan. As appropriate, these business documents may be inputs to some of the processes involved in managing the project, such as developing the project charter.

1.5 THE PROJECT LIFE CYCLE

A project life cycle is the series of phases that a project passes through from its start to its completion. A project phase is a collection of logically related project activities that culminates in the completion of one or more deliverables. The phases can be sequential, iterative, or overlapping. The names, number, and duration of the project phases are determined by the management and control needs of the organization(s) involved in the project, the nature of the project itself, and its area of application. Phases are time bound, with a start and end or control point (sometimes referred to as a phase review, phase gate, control gate, or other similar term). At the control point, the project charter and business documents are reexamined based on the current environment. At that time, the project's performance is compared to the project management plan to determine if the project should be changed, terminated, or continue as planned.

The project life cycle can be influenced by the unique aspects of the organization, industry, development method, or technology employed. While every project has a start and end, the specific deliverables and work that take place vary widely depending on the project. The life cycle provides the basic framework for managing the project, regardless of the specific work involved.

Though projects vary in size and the amount of complexity they contain, a typical project can be mapped to the following project life cycle structure (see Figure 1-2):

- ◆ Starting the project,
- ◆ Organizing and preparing,
- ◆ Carrying out the work, and
- ◆ Closing the project.

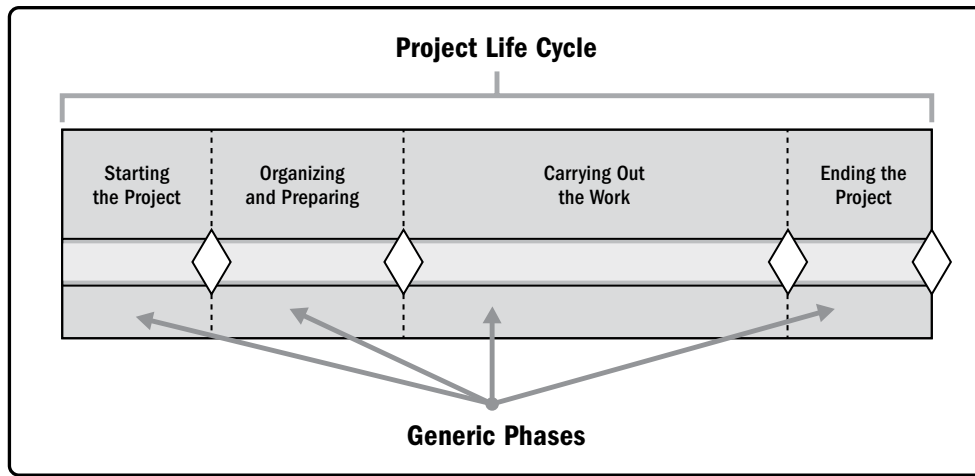

Figure 1-2. Generic Depiction of a Project Life Cycle

A generic life cycle structure typically displays the following characteristics:

- ◆ Cost and staffing levels are low at the start, increase as the work is carried out, and drop rapidly as the project draws to a close.
- ◆ Risk is greatest at the start of the project as illustrated by Figure 1-3. These factors decrease over the life cycle of the project as decisions are reached and as deliverables are accepted.
- ◆ The ability of stakeholders to influence the final characteristics of the project's product, without significantly impacting cost and schedule, is highest at the start of the project and decreases as the project progresses toward completion. Figure 1-3 illustrates the cost of making changes and correcting errors typically increases substantially as the project approaches completion.

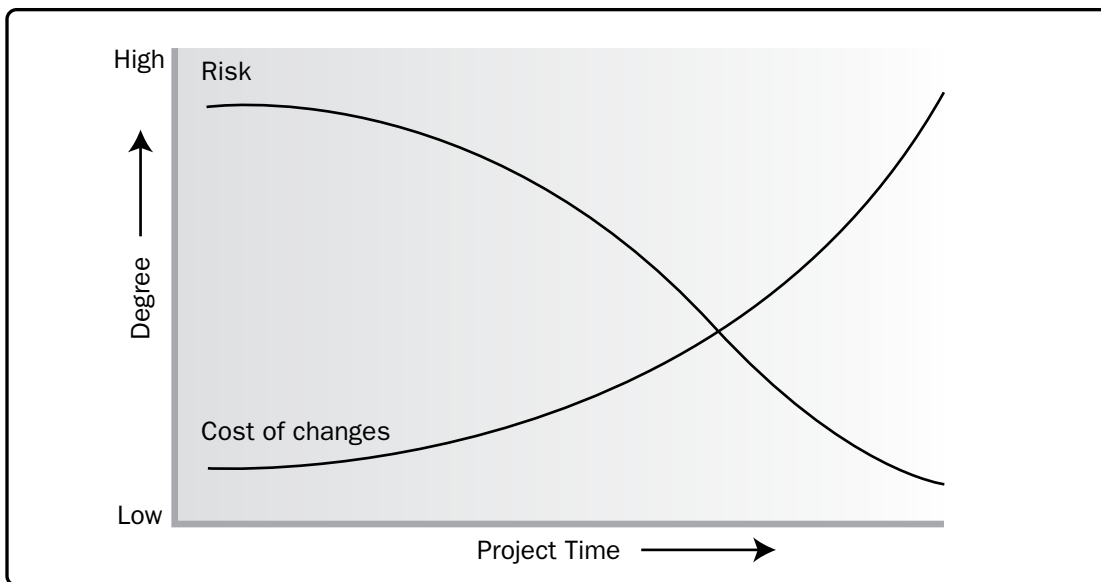

Figure 1-3. Impact of Variables Over Time

1.6 PROJECT STAKEHOLDERS

A stakeholder is an individual, group, or organization that may affect, be affected by, or perceive itself to be affected by a decision, activity, or outcome of a project. Project stakeholders may be internal or external to the project, they may be actively involved, passively involved, or unaware of the project. Project stakeholders may have a positive or negative impact on the project, or be positively or negatively impacted by the project. Examples of stakeholders include but are not limited to:

◆ *Internal stakeholders:*

- Sponsor,
- Resource manager,
- Project management office (PMO),
- Portfolio steering committee,
- Program manager,
- Project managers of other projects, and
- Team members.

◆ *External stakeholders:*

- Customers,
- End users,
- Suppliers,
- Shareholders
- Regulatory bodies, and
- Competitors

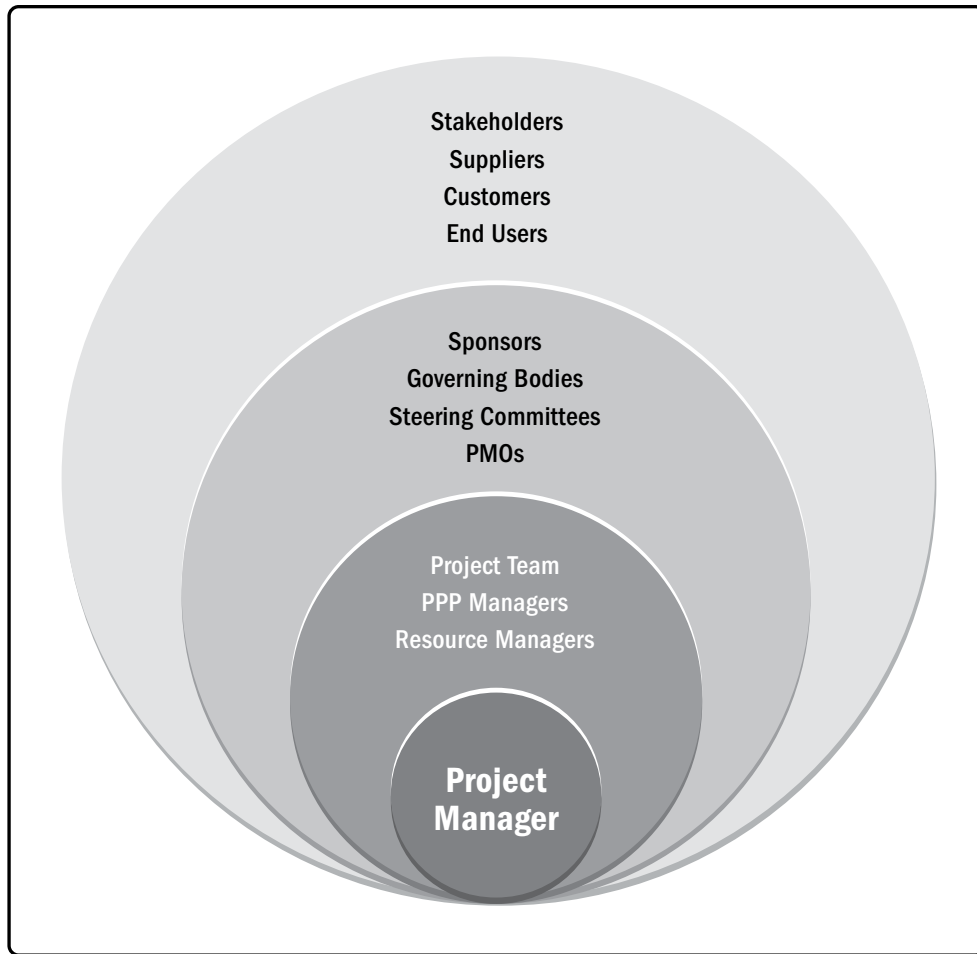

Figure 1-4. Examples of Project Stakeholders

Figure 1-4 shows examples of project stakeholders. Stakeholder involvement may range from occasional contributions in surveys and focus groups to full project sponsorship that includes the provision of financial, political, or other types of support. The type and level of project involvement can change over the course of the project's life cycle. Therefore, successfully identifying, analyzing, and engaging stakeholders and effectively managing their project expectations and participation throughout the project life cycle is critical to project success.

1.7 ROLE OF THE PROJECT MANAGER

The project manager is the person assigned by the performing organization to lead the team responsible for achieving the project objectives. The project manager's reporting relationships are based on the organizational structure and project governance.

In addition to any specific technical skills and general management proficiencies required for the project, project managers should have at least the following attributes:

- ◆ Knowledge about project management, the business environment, technical aspects, and other information needed to manage the project effectively;
- ◆ Skills needed to effectively lead the project team, coordinate the work, collaborate with stakeholders, solve problems, and make decisions;
- ◆ Abilities to develop and manage scope, schedules, budgets, resources, risks, plans, presentations, and reports; and
- ◆ Other attributes required to successfully manage the project, such as personality, attitude, ethics, and leadership.

Project managers accomplish work through the project team and other stakeholders. Project managers rely on important interpersonal skills, including, but not limited to:

- ◆ Leadership,
- ◆ Team building,
- ◆ Motivating,
- ◆ Communicating,
- ◆ Influencing,
- ◆ Decision making,
- ◆ Political and cultural awareness,
- ◆ Negotiating,
- ◆ Facilitating,
- ◆ Managing conflict, and
- ◆ Coaching.

The project manager is successful when the project objectives have been achieved. Another aspect of success is stakeholder satisfaction. The project manager should address stakeholder needs, concerns and expectations to satisfy relevant stakeholders. To be successful, the project manager should tailor the project approach, life cycle, and project management processes to meet the project and product requirements.

1.8 PROJECT MANAGEMENT KNOWLEDGE AREAS

The Project Management Knowledge Areas are fields or areas of specialization that are commonly employed when managing projects. A Knowledge Area is a set of processes associated with a particular topic in project management. These 10 Knowledge Areas are used on most projects most of the time. The needs of a specific project may require additional Knowledge Areas. The 10 Knowledge Areas are:

- ◆ **Project Integration Management.** Project Integration Management includes the processes and activities to identify, define, combine, unify, and coordinate the various processes and project management activities within the Project Management Process Groups.
- ◆ **Project Scope Management.** Project Scope Management includes the processes required to ensure that the project includes all the work required, and only the work required, to complete the project successfully.
- ◆ **Project Schedule Management.** Project Schedule Management includes the processes required to manage the timely completion of the project.
- ◆ **Project Cost Management.** Project Cost Management includes the processes involved in planning, estimating, budgeting, financing, funding, managing, and controlling costs so the project can be completed within the approved budget.
- ◆ **Project Quality Management.** Project Quality Management includes the processes for incorporating the organization's quality policy regarding planning, managing, and controlling project and product quality requirements, in order to meet stakeholders' expectations.
- ◆ **Project Resource Management.** Project Resource Management includes the processes to identify, acquire, and manage the resources needed for the successful completion of the project.
- ◆ **Project Communications Management.** Project Communications Management includes the processes required to ensure timely and appropriate planning, collection, creation, distribution, storage, retrieval, management, control, monitoring, and ultimate disposition of project information.
- ◆ **Project Risk Management.** Project Risk Management includes the processes of conducting risk management planning, identification, analysis, response planning, response implementation, and monitoring risk on a project.
- ◆ **Project Procurement Management.** Project Procurement Management includes the processes necessary to purchase or acquire products, services, or results needed from outside the project team.
- ◆ **Project Stakeholder Management.** Project Stakeholder Management includes the processes required to identify the people, groups, or organizations that could impact or be impacted by the project, to analyze stakeholder expectations and their impact on the project, and to develop appropriate management strategies for effectively engaging stakeholders in project decisions and execution.

1.9 PROJECT MANAGEMENT PROCESS GROUPS

This standard describes the project management processes employed to meet project objectives. Project management processes are grouped in five Project Management Process Groups:

- ◆ **Initiating Process Group.** The process(es) performed to define a new project or a new phase of an existing project by obtaining authorization to start the project or phase. Initiating processes are described in Section 2.
- ◆ **Planning Process Group.** The process(es) required to establish the scope of the project, refine the objectives, and define the course of action required to attain the objectives that the project was undertaken to achieve. Planning processes are described in Section 3.
- ◆ **Executing Process Group.** The process(es) performed to complete the work defined in the project management plan to satisfy the project requirements. Executing processes are described in Section 4.
- ◆ **Monitoring and Controlling Process Group.** The process(es) required to track, review, and regulate the progress and performance of the project; identify any areas in which changes to the plan are required; and initiate the corresponding changes. Monitoring and Controlling processes are described in Section 5.
- ◆ **Closing Process Group.** The process(es) performed to formally complete or close a project, phase, or contract. Closing processes are described in Section 6.

These five Process Groups are independent of the application areas, (such as marketing, information services, or accounting) or industry focus (such as construction, aerospace, telecommunications). Individual processes in the Process Groups are often iterated prior to completing a phase or a project. The number of process iterations and interactions between processes varies based on the needs of the project. Processes generally fall into one of three categories:

- ◆ **Processes used once or at predefined points in the project.** Developing the project charter and closing the project or phase are examples.
- ◆ **Processes that are performed periodically as needed.** Acquiring resources is performed when resources are needed. Conducting procurements will be performed prior to needing the procured item.
- ◆ **Processes that are performed continuously throughout the project.** Defining activities may occur throughout the project life cycle, especially when the project uses rolling wave planning or an adaptive development approach. Many of the monitoring and control processes are ongoing from the start of the project, until it is closed out.

The output of one process generally becomes an input to another process or is a deliverable of the project or project phase. For example, the project management plan and project documents (e.g., risk register, responsibility assignment matrix, etc.) produced in the Planning Process Group are provided to the Executing Process Group where updates are made. Figure 1-4 illustrates an example of how Process Groups can overlap during a project or phase.

Process Groups are not project phases. If the project is divided into phases, the processes in the Process Groups interact within each phase. It is possible that all Process Groups could be represented within a phase, as illustrated in Figure 1-5. As projects are separated into distinct phases, such as concept development, feasibility study, design, prototype, build, or test, etc., processes in each of the Process Groups are repeated as necessary in each phase until the completion criteria for that phase have been satisfied.

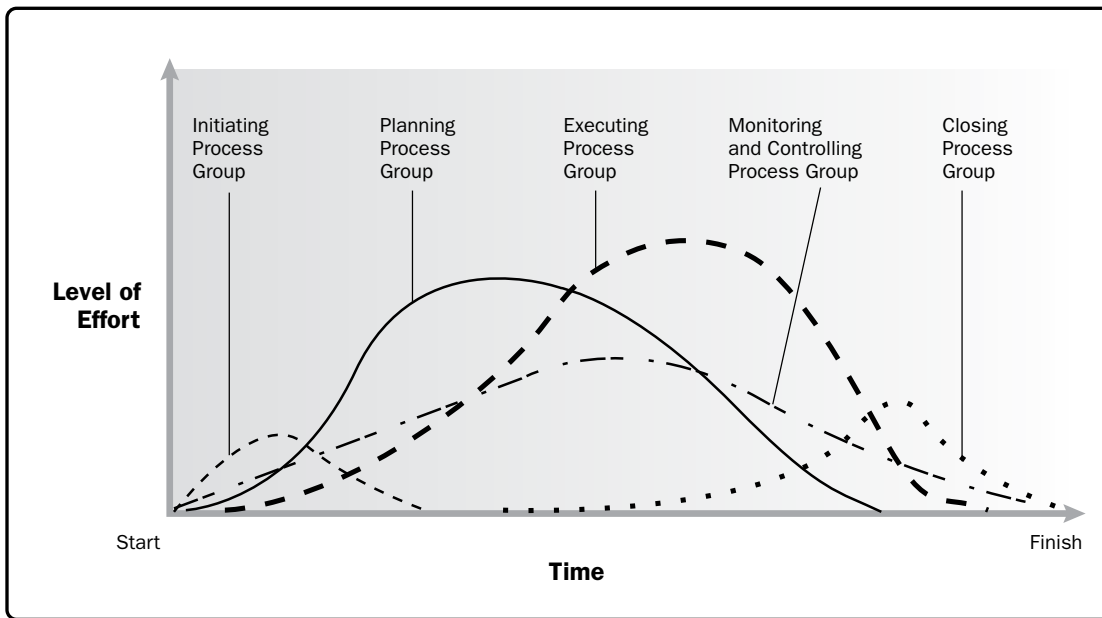

Figure 1-5. Example of Process Group Interactions Within a Project or Phase

Table 1-1 shows the 49 processes mapped to the Process Groups and Knowledge Areas.



Table 1-1. Project Management Process Group and Knowledge Area Mapping

Knowledge Areas	Project Management Process Groups				
	Initiating Process Group	Planning Process Group	Executing Process Group	Monitoring and Controlling Process Group	Closing Process Group
4. Project Integration Management	4.1 Develop Project Charter	4.2 Develop Project Management Plan	4.3 Direct and Manage Project Work 4.4 Manage Project Knowledge	4.5 Monitor and Control Project Work 4.6 Perform Integrated Change Control	4.7 Close Project or Phase
5. Project Scope Management		5.1 Plan Scope Management 5.2 Collect Requirements 5.3 Define Scope 5.4 Create WBS		5.5 Validate Scope 5.6 Control Scope	
6. Project Schedule Management		6.1 Plan Schedule Management 6.2 Define Activities 6.3 Sequence Activities 6.4 Estimate Activity Durations 6.5 Develop Schedule		6.6 Control Schedule	
7. Project Cost Management		7.1 Plan Cost Management 7.2 Estimate Costs 7.3 Determine Budget		7.4 Control Costs	
8. Project Quality Management		8.1 Plan Quality Management	8.2 Manage Quality	8.3 Control Quality	
9. Project Resource Management		9.1 Plan Resource Management 9.2 Estimate Activity Resources	9.3 Acquire Resources 9.4 Develop Team 9.5 Manage Team	9.6 Control Resources	
10. Project Communications Management		10.1 Plan Communications Management	10.2 Manage Communications	10.3 Monitor Communications	
11. Project Risk Management		11.1 Plan Risk Management 11.2 Identify Risks 11.3 Perform Qualitative Risk Analysis 11.4 Perform Quantitative Risk Analysis 11.5 Plan Risk Responses	11.6 Implement Risk Responses	11.7 Monitor Risks	
12. Project Procurement Management		12.1 Plan Procurement Management	12.2 Conduct Procurements	12.3 Control Procurements	
13. Project Stakeholder Management	13.1 Identify Stakeholders	13.2 Plan Stakeholder Engagement	13.3 Manage Stakeholder Engagement	13.4 Monitor Stakeholder Engagement	

1.10 ENTERPRISE ENVIRONMENTAL FACTORS AND ORGANIZATIONAL PROCESS ASSETS

Projects exist and operate in environments that may have an influence on them. These influences can have a favorable or unfavorable impact on the project. Two major categories of influences are enterprise environmental factors (EEFs) and organizational process assets (OPAs).

EEFs originate from the environment outside of the project and often outside of the enterprise. These factors refer to conditions, which are not under the control of the project team, that influence, constrain, or direct the project. EEFs may have an impact at the enterprise, portfolio, program, or project level. (Refer to Section 2.2 in the *PMBOK® Guide* for additional information on EEFs.) One set of such factors are the internal organizational culture, structure and governance. Examples in this area include but are not limited to: vision, mission, values, beliefs, cultural norms, hierarchy, and authority relationships.

OPAs are internal to the enterprise. These may arise from the enterprise itself, a portfolio, a program, another project, or a combination of these. OPAs are the plans, processes, policies, procedures, and knowledge bases specific to and used by the performing organization. These assets influence the management of the project. Examples include but are not limited to: change control procedures, templates, information from previous projects, and lessons learned repositories. (Refer to Section 2.3 in the *PMBOK® Guide* for additional information on OPAs).



1.11 TAILORING THE PROJECT ARTIFACTS

The term artifact in this context includes project management processes, inputs, tools, techniques, outputs, EEFs, and OPAs. The project manager and the project management team select and adapt the appropriate artifacts for use on their specific project. This selection and adaptation activity is known as tailoring. Tailoring is necessary because each project is unique; therefore, not every process, input, tool, technique, or output is required on every project.

The project management plan is the most prevalent artifact. It has many components, such as the subsidiary management plans, baselines, and a description of the project life cycle. Subsidiary management plans are plans associated with a specific aspect or Knowledge Area of the project, for example, a schedule management plan, risk management plan and change management plan. Part of tailoring is identifying the project management plan components needed for a particular project. The project management plan is an input and project management plan updates are an output of many processes in this standard. Rather than listing the individual project management plan components in the input/output tables, examples of the components that *may* be inputs or *may* be updated as outputs are listed beneath the input/output tables for each process. The possible components are listed as examples only. These inputs and outputs are not required and are not the only inputs or updates to the project management plan that a project manager may use in that particular process.

The project management plan is one of the primary project artifacts, but there are other documents that are not part of the project management plan that are used to manage the project. These other documents are called project documents. Similar to project management plan components, project documents needed for a process will depend on the individual project. The project manager is accountable for identifying the project documents needed for a process and the project documents that will be updated as an output of a process. The project documents listed beneath the input/output tables throughout this standard are possible examples of project documents, not a comprehensive list.

Table 1-2 is a representative list of project management plan components and project documents. It is not complete list, but it does provide a representation of the types of documents that are often used to help manage a project.



Table 1-2. Project Management Plan and Project Documents

Project Management Plan	Project Documents	
1. Scope management plan	1. Activity attributes	19. Quality control measurements
2. Requirements management plan	2. Activity list	20. Quality metrics
3. Schedule management plan	3. Assumption log	21. Quality report
4. Cost management plan	4. Basis of estimates	22. Requirements documentation
5. Quality management plan	5. Change log	23. Requirements traceability matrix
6. Resource management plan	6. Cost estimates	24. Resource breakdown structure
7. Communications management plan	7. Cost forecasts	25. Resource calendars
8. Risk management plan	8. Duration estimates	26. Resource requirements
9. Procurement management plan	9. Issue log	27. Risk register
10. Stakeholder engagement plan	10. Lessons learned register	28. Risk report
11. Change management plan	11. Milestone list	29. Schedule data
12. Configuration management plan	12. Physical resource assignments	30. Schedule forecasts
13. Scope baseline	13. Project calendars	31. Stakeholder register
14. Schedule baseline	14. Project communications	32. Team charter
15. Cost baseline	15. Project schedule	33. Test and evaluation documents
16. Performance measurement baseline	16. Project schedule network diagram	
17. Project life cycle description	17. Project scope statement	
18. Development approach	18. Project team assignments	

Business documents are documents that are generally originated outside of the project, and are used as inputs to the project. Examples of business documents include the business case and benefits management plan. The use of the business documents will depend on the company culture and project initiation process.

The enterprise environmental factors that influence the project and the organizational process assets available to the project will depend on the project and project environment and are not listed in this standard.



2

INITIATING PROCESS GROUP

The Initiating Process Group consists of those processes performed to define a new project or a new phase of an existing project by obtaining authorization to start the project or phase. The purpose of the Initiating Process Group is to align the stakeholders' expectations and the project purpose, inform stakeholders of the scope and objectives, and discuss how their participation in the project and its associated phases can help to ensure their expectations are met. Within the Initiating processes, the initial scope is defined and initial financial resources are committed. Stakeholders who will interact and influence the overall outcome of the project are identified. If not already assigned, the project manager is appointed. This information is captured in the project charter and stakeholder register. When the project charter is approved, the project is officially authorized, and the project manager is authorized to apply organizational resources to project activities.

The key benefits of this Process Group are that only projects that are aligned with the organization's strategic objectives are authorized and that the business case, benefits, and stakeholders are considered from the start of the project. In some organizations, the project manager is involved in developing the business case and defining the benefits. In those organizations, the project manager generally helps write the project charter; in other organizations, the pre-project work is done by the project sponsor, project management office (PMO), portfolio steering committee, or other stakeholder group. This standard assumes the project has been approved by the sponsor or other governing body and they have reviewed the business documents prior to authorizing the project.

Business documents are documents that are generally originated outside of the project, but are used as input to the project. Examples of business documents include the business case, and benefits management plan. Figure 2-1 shows the sponsor and the business documents in relation to the Initiating Processes.



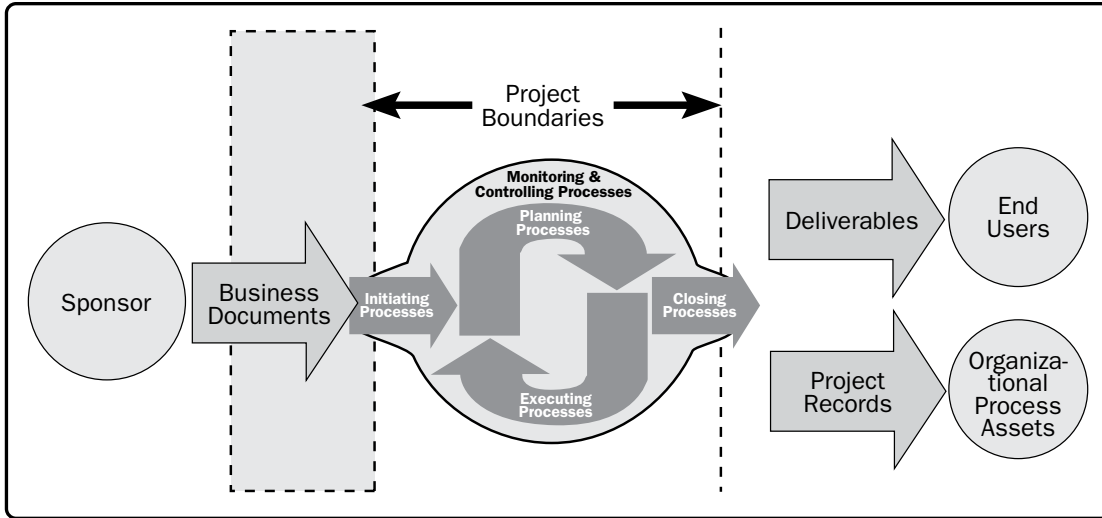

Figure 2-1. Project Boundaries

As described in Section 1.5, projects are often divided into phases. When this is done, information from processes in the Initiating Process Group is reexamined to determine if the information is still valid. Revisiting the Initiating processes at the start of each phase helps keep the project focused on the business need that the project was undertaken to address. The project charter, business documents, and success criteria are verified. The influence, drivers, expectations, and objectives of the project stakeholders are reviewed.

Involving the sponsors, customers, and other stakeholders during initiation creates a shared understanding of success criteria. It also increases the likelihood of deliverable acceptance when the project is complete, and stakeholder satisfaction throughout the project.

The Initiating Process Group includes the project management processes identified in Sections 2.1 through 2.2.

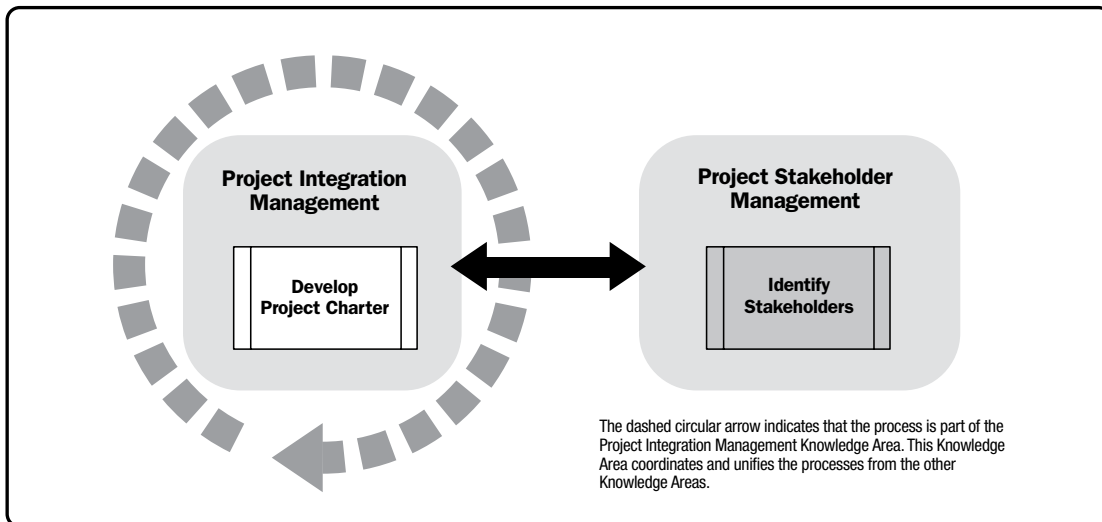

Figure 2-2. Initiating Process Group

2.1 DEVELOP PROJECT CHARTER

Develop Project Charter is the process of developing a document that formally authorizes the existence of a project and provides the project manager with the authority to apply organizational resources to project activities. The key benefits of this process are that it provides a direct link between the project and the strategic objectives of the organization, creates a formal record of the project, and shows the organizational commitment to the project. This process is performed once, or at predefined points in the project. The inputs and outputs of this process are shown in Figure 2-3.

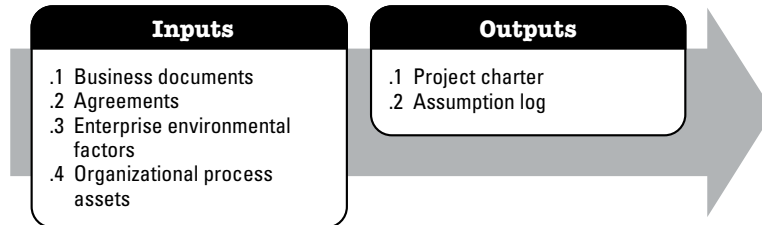

Figure 2-3. Develop Project Charter: Inputs and Outputs

2.2 IDENTIFY STAKEHOLDERS

Identify Stakeholders is the process of identifying project stakeholders regularly and analyzing and documenting relevant information regarding their interests, involvement, interdependencies, influence, and potential impact on project success. The key benefit of this process is that it enables the project team to identify the appropriate focus for engagement of each stakeholder or group of stakeholders. This process is performed periodically throughout the project as needed. The inputs and outputs of this process are depicted in Figure 2-4.

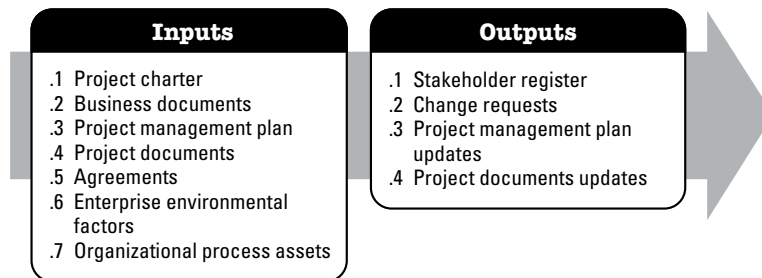

Figure 2-4. Identify Stakeholders: Inputs and Outputs

The needs of the project determine which components of the project management plan and which project documents are necessary.

2.2.1 PROJECT MANAGEMENT PLAN COMPONENTS

Examples of project management plan components that may be inputs for this process include but are not limited to:

- ◆ Communications management plan, and
- ◆ Stakeholder engagement plan.

2.2.2 PROJECT DOCUMENTS EXAMPLES

Examples of project documents that may be inputs for this process include but are not limited to:

- ◆ Change log,
- ◆ Issue log, and
- ◆ Requirements documentation.

2.2.3 PROJECT MANAGEMENT PLAN UPDATES

Examples of project management plan components that may be updated as a result of this process include but are not limited to:

- ◆ Requirements management plan,
- ◆ Communications management plan,
- ◆ Risk management plan, and
- ◆ Stakeholder engagement plan.

2.2.4 PROJECT DOCUMENTS UPDATES

Examples of project documents that may be updated as a result of this process include but are not limited to:

- ◆ Assumption log,
- ◆ Issue log, and
- ◆ Risk register.

3

PLANNING PROCESS GROUP

The Planning Process Group consists of those processes that establish the total scope of the effort, define and refine the objectives, and develop the course of action required to attain those objectives. The processes in the Planning Process Group develop the components of the project management plan and the project documents used to carry out the project. The nature of a project may require the use of repeated feedback loops for additional analysis. As more project information or characteristics are gathered and understood, additional planning will likely be required. Significant changes that occur throughout the project life cycle may initiate a need to revisit one or more of the planning processes and, possibly, one or both of the Initiating processes. This ongoing refinement of the project management plan is called progressive elaboration, indicating that planning and documentation are iterative or ongoing activities. The key benefit of this Process Group is to define the course of action to successfully complete the project or phase.

The project management team seeks input and encourages involvement from relevant stakeholders while planning the project and developing the project management plan and project documents. When the initial planning effort is completed, the approved version of the project management plan is considered a baseline. Throughout the project, the Monitoring and Controlling processes compare the project performance to the baselines.

The Planning Process Group (Figure 3-1) includes the project management processes identified in Sections 3.1 to 3.24.



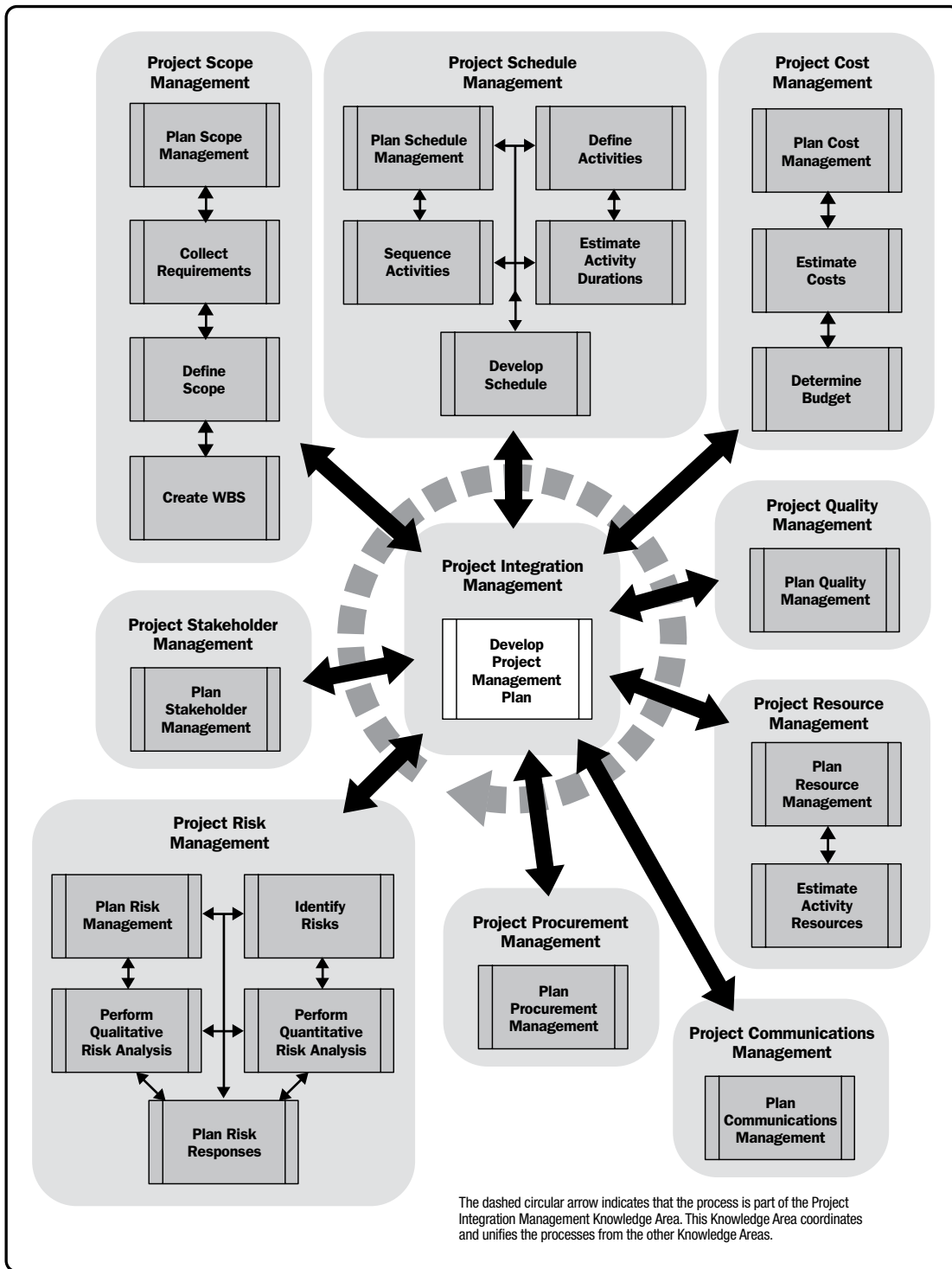

Figure 3-1. Planning Process Group

3.1 DEVELOP PROJECT MANAGEMENT PLAN

Develop Project Management Plan is the process of defining, preparing, and coordinating all plan components and consolidating them into an integrated project management plan. The key benefit of this process is the production of a comprehensive document that defines the basis of all project work and how the work will be performed. This process is performed once or at predefined points in the project. The inputs and outputs of this process are depicted in Figure 3-2.

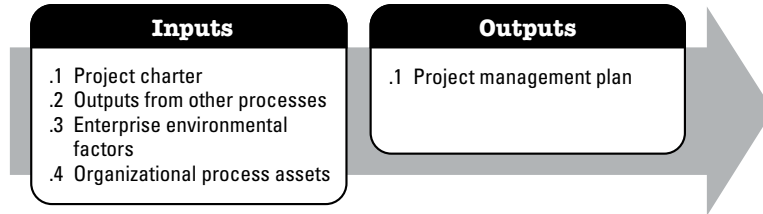

Figure 3-2. Develop Project Management Plan: Inputs and Outputs

The needs of the project determine which components of the project management plan and which project documents are necessary.

3.2 PLAN SCOPE MANAGEMENT

Plan Scope Management is the process of creating a scope management plan that documents how the project and product scope will be defined, validated, and controlled. The key benefit of this process is that it provides guidance and direction on how scope will be managed throughout the project. This process is performed once or at predefined points in the project. The inputs and outputs of this process are depicted in Figure 3-3.

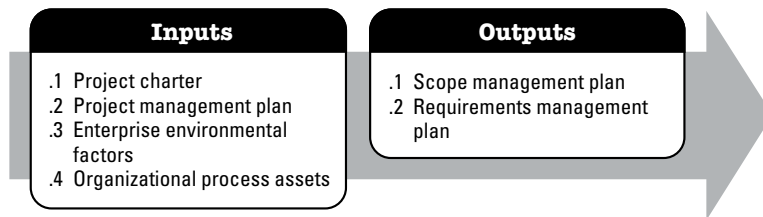

Figure 3-3. Plan Scope Management: Inputs and Outputs

The needs of the project determine which components of the project management plan are necessary.

3.2.1 PROJECT MANAGEMENT PLAN COMPONENTS

Examples of project management plan components that may be inputs for this process include but are not limited to:

- ◆ Quality management plan,
- ◆ Project life cycle description, and
- ◆ Development approach.

3.3 COLLECT REQUIREMENTS

Collect Requirements is the process of determining, documenting, and managing stakeholder needs and requirements to meet objectives. The key benefit of this process is that it provides the basis for defining the product scope and project scope. This process is performed once or at predefined points in the project. The inputs and outputs of this process are depicted in Figure 3-4.

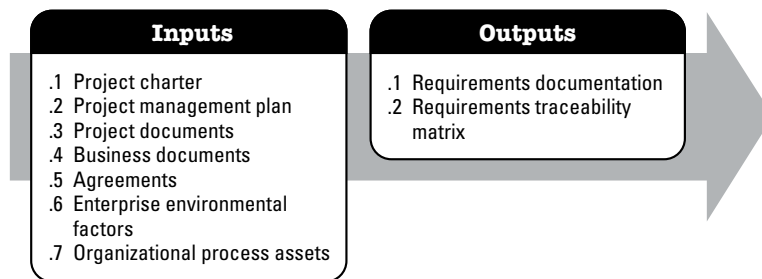

Figure 3-4. Collect Requirements: Inputs and Outputs

The needs of the project determine which components of the project management plan and which project documents are necessary.

3.3.1 PROJECT MANAGEMENT PLAN COMPONENTS

Examples of project management plan components that may be inputs for this process include but are not limited to:

- ◆ Scope management plan,
- ◆ Requirements management plan, and
- ◆ Stakeholder engagement plan.

3.3.2 PROJECT DOCUMENTS EXAMPLES

Examples of project documents that may be inputs for this process include but are not limited to:

- ◆ Assumption log,
- ◆ Lessons learned register, and
- ◆ Stakeholder register.

3.4 DEFINE SCOPE

Define Scope is the process of developing a detailed description of the project and product. The key benefit of this process is that it describes the product, service, or result boundaries and acceptance criteria. This process is performed once or at predefined points in the project. The inputs and outputs of this process are depicted in Figure 3-5.

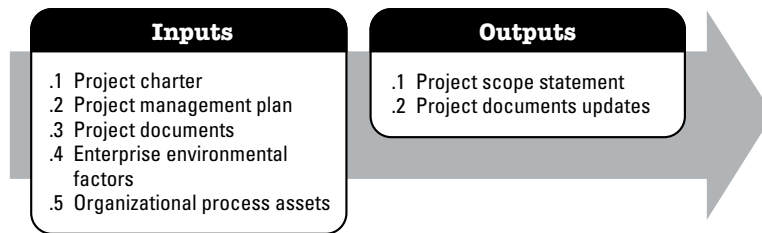

Figure 3-5. Define Scope: Inputs and Outputs

The needs of the project determine which components of the project management plan and which project documents are necessary.

3.4.1 PROJECT MANAGEMENT PLAN COMPONENTS

An example of a project management plan component that may be an input for this process includes but is not limited to the scope management plan.

3.4.2 PROJECT DOCUMENTS EXAMPLES

Examples of project documents that may be inputs for this process include but are not limited to:

- ◆ Assumption log,
- ◆ Requirements documentation, and
- ◆ Risk register.

3.4.3 PROJECT DOCUMENTS UPDATES

Project documents that may be updated as a result of this process include but are not limited to:

- ◆ Assumption log,
- ◆ Requirements documentation,
- ◆ Requirements traceability matrix, and
- ◆ Stakeholder register.

3.5 CREATE WBS

Create Work Breakdown Structure (WBS) is the process of subdividing project deliverables and project work into smaller, more manageable components. The key benefit of this process is that it provides a framework of what has to be delivered. This process is performed once or at predefined points in the project. The inputs and outputs of this process are depicted in Figure 3-6.

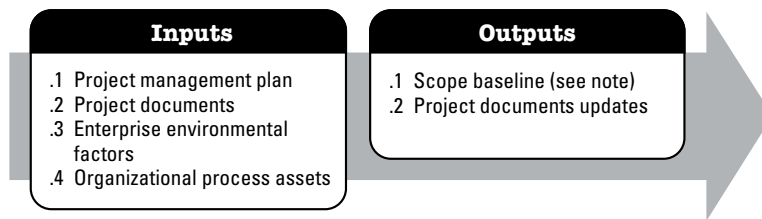

Note: The scope baseline is the approved version of a scope statement, WBS, and its associated WBS dictionary.

Figure 3-6. Create WBS: Inputs and Outputs

The needs of the project determine which components of the project management plan and which project documents are necessary.

3.5.1 PROJECT MANAGEMENT PLAN COMPONENTS

An example of a project management plan component that may be an input for this process includes but is not limited to the scope management plan.

3.5.2 PROJECT DOCUMENTS EXAMPLES

Examples of project documents that may be inputs for this process include but are not limited to:

- ◆ Project scope statement, and
- ◆ Requirements documentation.

3.5.3 PROJECT DOCUMENTS UPDATES

Project document that may be updated as a result of this process include but is not limited to:

- ◆ Assumption log, and
- ◆ Requirements documentation.

3.6 PLAN SCHEDULE MANAGEMENT

Plan Schedule Management is the process of establishing the policies, procedures, and documentation for planning, developing, managing, executing, and controlling the project schedule. The key benefit of this process is that it provides guidance and direction on how the project schedule will be managed throughout the project. This process is performed once or at predefined points in the project. The inputs and outputs of this process are depicted in Figure 3-7.

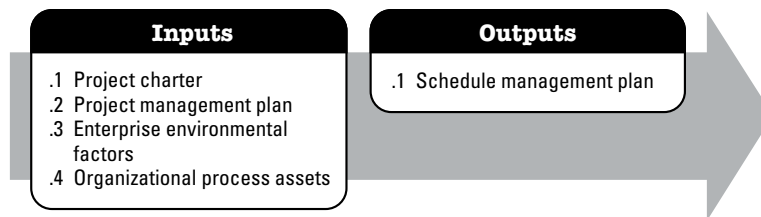

Figure 3-7. Plan Schedule Management: Inputs and Outputs

The needs of the project determine which components of the project management plan are necessary.

3.6.1 PROJECT MANAGEMENT PLAN COMPONENTS

Examples of project management plan components that may be inputs for this process include but are not limited to:

- ◆ Scope management plan, and
- ◆ Development approach.

3.7 DEFINE ACTIVITIES

Define Activities is the process of identifying and documenting the specific actions to be performed to produce the project deliverables. The key benefit of this process is that it decomposes work packages into schedule activities that provide a basis for estimating, scheduling, executing, monitoring, and controlling the project work. This process is performed throughout the project. The inputs and outputs of this process are depicted in Figure 3-8.

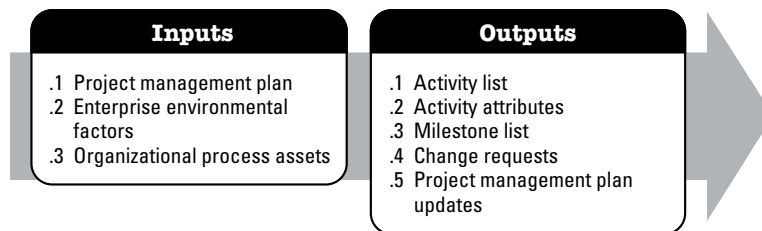

Figure 3-8. Define Activities: Inputs and Outputs

The needs of the project determine which components of the project management plan are necessary.

3.7.1 PROJECT MANAGEMENT PLAN COMPONENTS

Examples of project management plan components that may be inputs for this process include but are not limited to:

- ◆ Schedule management plan, and
- ◆ Scope baseline.

3.7.2 PROJECT MANAGEMENT PLAN UPDATES

Components of the project management plan that may be updated as a result of this process include but are not limited to:

- ◆ Schedule baseline, and
- ◆ Cost baseline.

3.8 SEQUENCE ACTIVITIES

Sequence Activities is the process of identifying and documenting relationships among the project activities. The key benefit of this process is that it defines the logical sequence of work to obtain the greatest efficiency given all project constraints. This process is performed throughout the project. The inputs and outputs of this process are depicted in Figure 3-9.

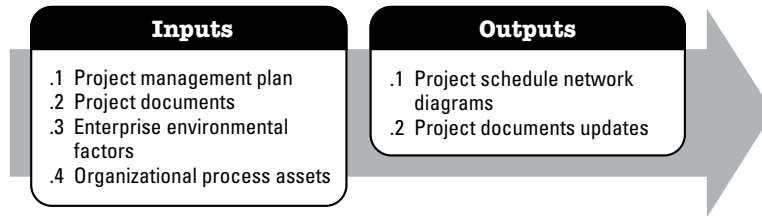

Figure 3-9. Sequence Activities: Inputs and Outputs

The needs of the project determine which components of the project management plan and which project documents are necessary.

3.8.1 PROJECT MANAGEMENT PLAN COMPONENTS

Examples of project management plan components that may be inputs for this process include but are not limited to:

- ◆ Schedule management plan, and
- ◆ Scope baseline.

3.8.2 PROJECT DOCUMENTS EXAMPLES

Examples of project documents that may be inputs for this process include but are not limited to:

- ◆ Activity attributes,
- ◆ Activity list,
- ◆ Assumption log, and
- ◆ Milestone list.

3.8.3 PROJECT DOCUMENTS UPDATES

Project documents that may be updated as a result of this process include but are not limited to:

- ◆ Activity attributes,
- ◆ Activity list,
- ◆ Assumption log, and
- ◆ Milestone list.

3.9 ESTIMATE ACTIVITY DURATIONS

Estimate Activity Durations is the process of estimating the number of work periods needed to complete individual activities with estimated resources. The key benefit of this process is that it provides the amount of time each activity will take to complete. This process is performed throughout the project. The inputs and outputs of this process are depicted in Figure 3-10.

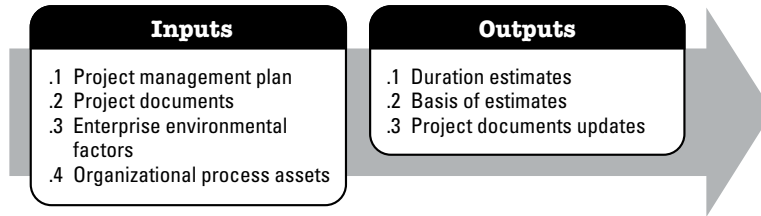

Figure 3-10. Estimate Activity Durations: Inputs and Outputs

The needs of the project determine which components of the project management plan and which project documents are necessary.

3.9.1 PROJECT MANAGEMENT PLAN COMPONENTS

Examples of project management plan components that may be inputs for this process include but are not limited to:

- ◆ Schedule management plan, and
- ◆ Scope baseline.

3.9.2 PROJECT DOCUMENTS EXAMPLES

Examples of project documents that may be inputs for this process include but are not limited to:

- ◆ Activity attributes,
- ◆ Activity list,
- ◆ Assumption log,
- ◆ Lessons learned register,
- ◆ Milestone list,
- ◆ Project team assignments,
- ◆ Resource breakdown structure,
- ◆ Resource calendars,
- ◆ Resource requirements, and
- ◆ Risk register.

3.9.3 PROJECT DOCUMENTS UPDATES

Project documents that may be updated as a result of this process include but are not limited to:

- ◆ Activity attributes,
- ◆ Assumption log,
- ◆ Lessons learned register.

3.10 DEVELOP SCHEDULE

Develop Schedule is the process of analyzing activity sequences, durations, resource requirements, and schedule constraints to create a schedule model for project execution and monitoring and controlling. The key benefit of this process is that it generates a schedule model with planned dates for completing project activities. This process is performed throughout the project. The inputs and outputs of this process are depicted in Figure 3-11.

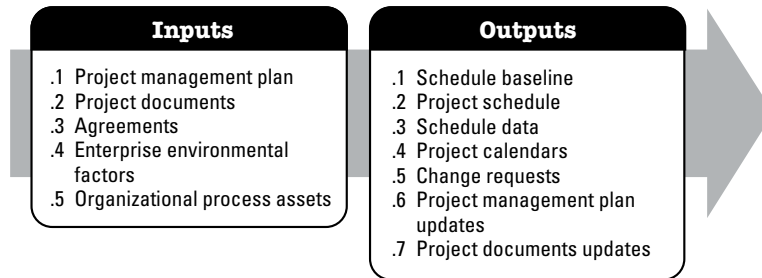

Figure 3-11. Develop Schedule: Inputs and Outputs

The needs of the project determine which components of the project management plan and which project documents are necessary.

3.10.1 PROJECT MANAGEMENT PLAN COMPONENTS

Examples of project management plan components that may be inputs for this process include but are not limited to:

- ◆ Schedule management plan, and
- ◆ Scope baseline.

3.10.2 PROJECT DOCUMENTS EXAMPLES

Examples of project documents that may be inputs for this process include but are not limited to:

- ◆ Activity attributes,
- ◆ Activity list,
- ◆ Assumption log,
- ◆ Basis of estimates,
- ◆ Duration estimates,
- ◆ Lessons learned register,
- ◆ Milestone list,
- ◆ Project schedule network diagram,
- ◆ Project team assignments,
- ◆ Resource calendars,
- ◆ Resource requirements, and
- ◆ Risk register.

3.10.3 PROJECT MANAGEMENT PLAN UPDATES

Components of the project management plan that may be updated as a result of this process include but are not limited to:

- ◆ Schedule management plan, and
- ◆ Cost baseline.

3.10.4 PROJECT DOCUMENTS UPDATES

Project documents that may be updated as a result of this process include but are not limited to:

- ◆ Activity attributes,
- ◆ Assumption log,
- ◆ Duration estimates,
- ◆ Lessons learned register,
- ◆ Resource requirements, and
- ◆ Risk register.

3.11 PLAN COST MANAGEMENT

Plan Cost Management is the process of defining how the project costs will be estimated, budgeted, managed, monitored, and controlled. The key benefit of this process is that it provides guidance and direction on how the project costs will be managed throughout the project. This process is performed once, or at predefined points in the project. The inputs and outputs of this process are depicted in Figure 3-12.

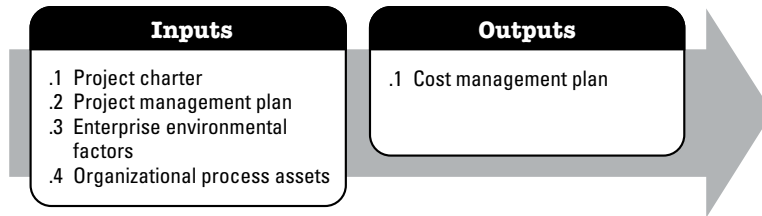

Figure 3-12. Plan Cost Management: Inputs and Outputs

The needs of the project determine which components of the project management plan are necessary.

3.11.1 PROJECT MANAGEMENT PLAN COMPONENTS

Examples of project management plan components that may be inputs for this process include but are not limited to:

- ◆ Schedule management plan, and
- ◆ Risk management plan.

3.12 ESTIMATE COSTS

Estimate Costs is the process of developing an approximation of the monetary resources needed to complete project work. The key benefit of this process is that it determines the monetary resources required for the project. This process is performed periodically throughout the project as needed. The inputs and outputs of this process are depicted in Figure 3-13.

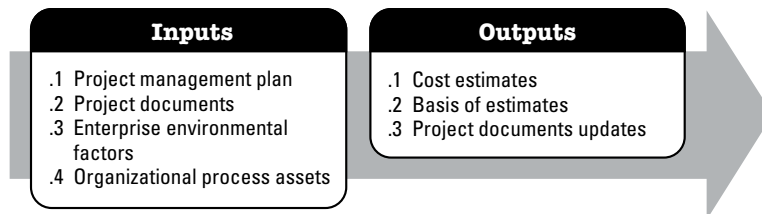

Figure 3-13. Estimate Costs: Inputs and Outputs

The needs of the project determine which components of the project management plan and which project documents are necessary.

3.12.1 PROJECT MANAGEMENT PLAN COMPONENTS

Examples of project management plan components that may be inputs for this process include but are not limited to:

- ◆ Cost management plan,
- ◆ Quality management plan, and
- ◆ Scope baseline.

3.12.2 PROJECT DOCUMENTS EXAMPLES

Examples of project documents that may be inputs for this process include but are not limited to:

- ◆ Lessons learned register,
- ◆ Project schedule,
- ◆ Resource requirements, and
- ◆ Risk register.

3.12.3 PROJECT DOCUMENTS UPDATES

Project documents that may be updated as a result of this process include but are not limited to:

- ◆ Assumption log,
- ◆ Lessons learned register, and
- ◆ Risk register.

3.13 DETERMINE BUDGET

Determine Budget is the process of aggregating the estimated costs of individual activities or work packages to establish an authorized cost baseline. The key benefit of this process is that it determines the cost baseline against which project performance can be monitored and controlled. This process is performed once or at predefined points in the project. The inputs and outputs of this process are depicted in Figure 3-14.

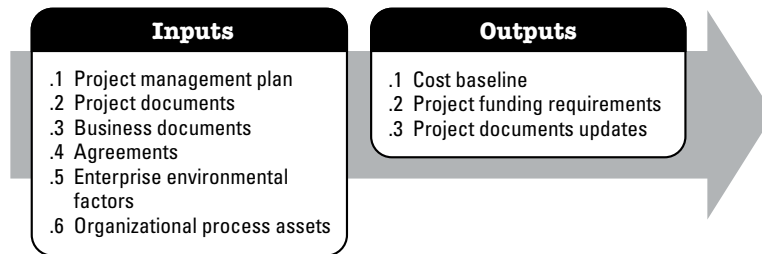

Figure 3-14. Determine Budget: Inputs and Outputs

The needs of the project determine which components of the project management plan and which project documents are necessary.

3.13.1 PROJECT MANAGEMENT PLAN COMPONENTS

Examples of project management plan components that may be inputs for this process include but are not limited to:

- ◆ Cost management plan,
- ◆ Resource management plan, and
- ◆ Scope baseline.

3.13.2 PROJECT DOCUMENTS EXAMPLES

Examples of project documents that may be inputs for this process include but are not limited to:

- ◆ Basis of estimates,
- ◆ Cost estimates,
- ◆ Project schedule, and
- ◆ Risk register.

3.13.3 PROJECT DOCUMENTS UPDATES

Project documents that may be updated as a result of this process include but are not limited to:

- ◆ Cost estimates,
- ◆ Project schedule, and
- ◆ Risk register.

3.14 PLAN QUALITY MANAGEMENT

Plan Quality Management is the process of identifying quality requirements and/or standards for the project and its deliverables, and documenting how the project will demonstrate compliance with quality requirements and/or standards. The key benefit of this process is that it provides guidance and direction on how quality will be managed and verified throughout the project. This process is performed once or at predefined points in the project. The inputs and outputs of this process are shown in Figure 3-15.

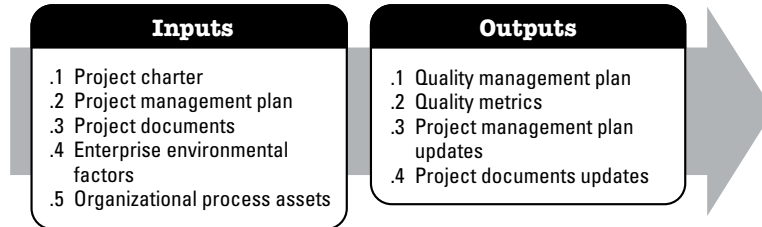

Figure 3-15. Plan Quality Management: Inputs and Outputs

The needs of the project determine which components of the project management plan and which project documents are necessary.

3.14.1 PROJECT MANAGEMENT PLAN COMPONENTS

Examples of project management plan components that may be inputs for this process include but are not limited to:

- ◆ Requirements management plan,
- ◆ Risk management plan,
- ◆ Stakeholder engagement plan, and
- ◆ Scope baseline.

3.14.2 PROJECT DOCUMENTS EXAMPLES

Examples of project documents that may be inputs for this process include but are not limited to:

- ◆ Assumption log,
- ◆ Requirements documentation,
- ◆ Requirements traceability matrix,
- ◆ Risk register, and
- ◆ Stakeholder register.

3.14.3 PROJECT MANAGEMENT PLAN UPDATES

Examples of project management plan components that may be updated as a result of this process include but are not limited to:

- ◆ Risk management plan, and
- ◆ Scope baseline.

3.14.4 PROJECT DOCUMENTS UPDATES

Project documents that may be updated as a result of this process include but are not limited to:

- ◆ Lessons learned register,
- ◆ Requirements traceability matrix,
- ◆ Risk register, and
- ◆ Stakeholder register.

3.15 PLAN RESOURCE MANAGEMENT

Plan Resource Management is the process of defining how to estimate, acquire, manage, and utilize physical and team resources. The key benefit of this process is that it establishes the approach and level of management effort needed for managing project resources based on the type and complexity of the project. This process is performed once or at predefined points in the project. The inputs and outputs of this process are shown in Figure 3-16.

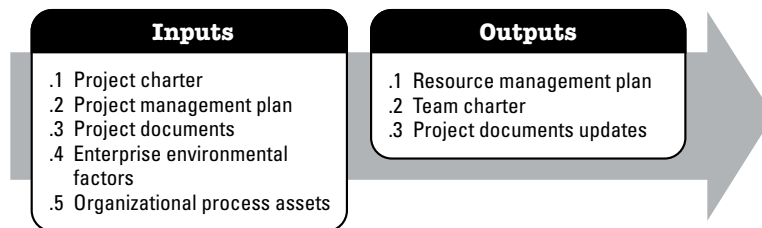

Figure 3-16. Plan Resource Management: Inputs and Outputs

The needs of the project determine which components of the project management plan and which project documents are necessary.

3.15.1 PROJECT MANAGEMENT PLAN COMPONENTS

Examples of project management plan components that may be inputs for this process include but are not limited to:

- ◆ Quality management plan, and
- ◆ Scope baseline.

3.15.2 PROJECT DOCUMENTS

Examples of project documents that may be inputs for this process include but are not limited to:

- ◆ Project schedule,
- ◆ Requirements documentation,
- ◆ Risk register, and
- ◆ Stakeholder register.

3.15.3 PROJECT DOCUMENTS UPDATES

Project documents that may be updated as a result of this process include but are not limited to:

- ◆ Assumption log, and
- ◆ Risk register.

3.16 ESTIMATE ACTIVITY RESOURCES

Estimate Activity Resources is the process of estimating team resources and the type and quantities of materials, equipment, and supplies necessary to perform project work. The key benefit of this process is that it identifies the type, quantity, and characteristics of resources required to complete the project. This process is performed periodically throughout the project as needed. The inputs and outputs of this process are depicted in Figure 3-17.

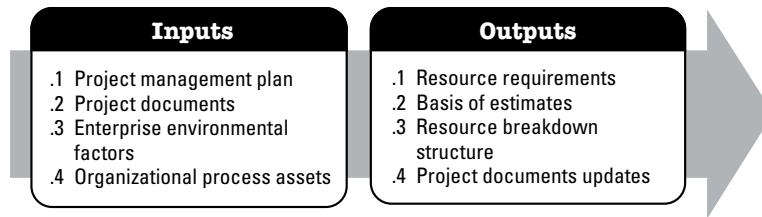

Figure 3-17. Estimate Activity Resources: Inputs and Outputs

The needs of the project determine which components of the project management plan and which project documents are necessary.

3.16.1 PROJECT MANAGEMENT PLAN COMPONENTS

Examples of project management plan components that may be inputs for this process include but are not limited to:

- ◆ Resource management plan, and
- ◆ Scope baseline.

3.16.2 PROJECT DOCUMENTS EXAMPLES

Examples of project documents that may be inputs for this process include but are not limited to:

- ◆ Activity attributes,
- ◆ Activity list,
- ◆ Assumption log,
- ◆ Cost estimates,
- ◆ Resource calendars, and
- ◆ Risk register.

3.16.3 PROJECT DOCUMENTS UPDATES

Project documents that may be updated as a result of this process include but are not limited to:

- ◆ Activity attributes,
- ◆ Assumption log,
- ◆ Lessons learned register.

3.17 PLAN COMMUNICATIONS MANAGEMENT

Plan Communications Management is the process of developing an appropriate approach and plan for project communication activities based on the information needs of each stakeholder or group, available organizational assets, and the needs of the project. The key benefit of this process is a documented approach to effectively and efficiently engage stakeholders by presenting relevant information in a timely manner. This process is performed periodically throughout the project as needed. The inputs and outputs of this process are depicted in Figure 3-18.

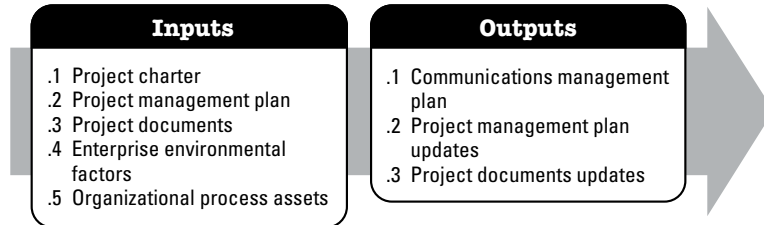

Figure 3-18. Plan Communications Management: Inputs and Outputs

The needs of the project determine which components of the project management plan and which project documents are necessary.

3.17.1 PROJECT MANAGEMENT PLAN COMPONENTS

Examples of project management plan components that may be inputs for this process include but are not limited to:

- ◆ Resource management plan, and
- ◆ Stakeholder engagement plan.

3.17.2 PROJECT DOCUMENTS EXAMPLES

Examples of project documents that may be inputs for this process include but are not limited to:

- ◆ Requirements documentation, and
- ◆ Stakeholder register.

3.17.3 PROJECT MANAGEMENT PLAN UPDATES

Components of the project management plan that may be updated as a result of this process include but are not limited to the stakeholder engagement plan.

3.17.4 PROJECT DOCUMENTS UPDATES

Project documents that may be updated as a result of this process include but are not limited to:

- ◆ Project schedule, and
- ◆ Stakeholder register.

3.18 PLAN RISK MANAGEMENT

Plan Risk Management is the process of defining how to conduct risk management activities for a project. The key benefit of this process is that it ensures that the degree, type, and visibility of risk management are proportionate to both the risks and the importance of the project to the organization and other stakeholders. This process is performed once or at predefined points in the project. The inputs and output of this process are depicted in Figure 3-19.

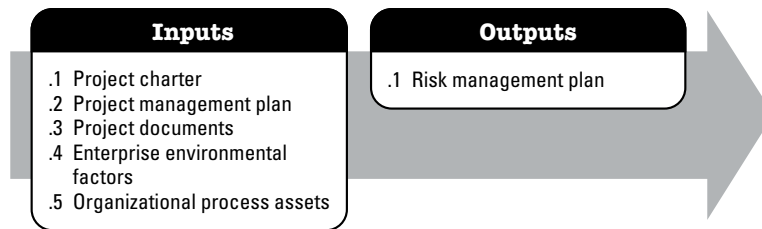

Figure 3-19. Plan Risk Management: Inputs and Outputs

The needs of the project determine which components of the project management plan and which project documents are necessary.

3.18.1 PROJECT MANAGEMENT PLAN COMPONENTS

In planning Project Risk Management, all available components of the project management plan should be taken into consideration in order to ensure risk management is consistent with the needs of the project.

3.18.2 PROJECT DOCUMENTS EXAMPLES

An example of a project document that may be an input for this process includes but is not limited to the stakeholder register.

3.19 IDENTIFY RISKS

Identify Risks is the process of identifying individual project risks as well as sources of overall project risk, and documenting their characteristics. The key benefit of this process is the documentation of the existing individual project risks and the sources of overall project risk. It also brings together information so the project team can respond appropriately to the identified risks. This process is performed throughout the project. The inputs and outputs of this process are depicted in Figure 3-20.

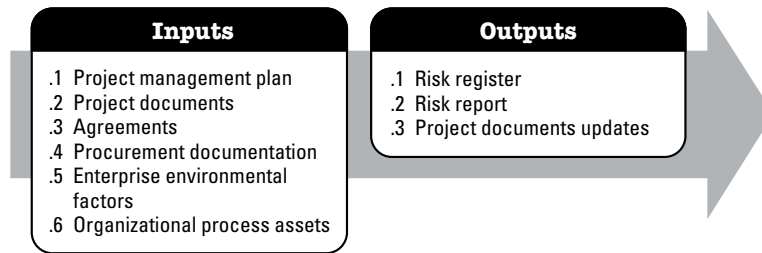

Figure 3-20. Identify Risks: Inputs and Outputs

The needs of the project determine which components of the project management plan and which project documents are necessary.

3.19.1 PROJECT MANAGEMENT PLAN COMPONENTS

Examples of project management plan components that may be inputs for this process include but are not limited to:

- ◆ Requirements management plan,
- ◆ Schedule management plan,
- ◆ Cost management plan,
- ◆ Quality management plan,
- ◆ Resource management plan,
- ◆ Risk management plan,
- ◆ Scope baseline,
- ◆ Schedule baseline, and
- ◆ Cost baseline.

3.19.2 PROJECT DOCUMENTS EXAMPLES

Examples of project documents that may be inputs for this process include but are not limited to:

- ◆ Assumption log,
- ◆ Cost estimates,
- ◆ Duration estimates,
- ◆ Issue log,
- ◆ Lessons learned register,
- ◆ Requirements documentation,
- ◆ Resource requirements, and
- ◆ Stakeholder register.

3.19.3 PROJECT DOCUMENTS UPDATES

Project documents that may be updated as a result of this process include but are not limited to:

- ◆ Assumption log,
- ◆ Issue log, and
- ◆ Lessons learned register.



3.20 PERFORM QUALITATIVE RISK ANALYSIS

Perform Qualitative Risk Analysis is the process of prioritizing individual project risks for further analysis or action by assessing their probability of occurrence and impact as well as other characteristics. The key benefit of this process is that it focuses efforts on high-priority risks. This process is performed throughout the project. The inputs and outputs of this process are depicted in Figure 3-21.

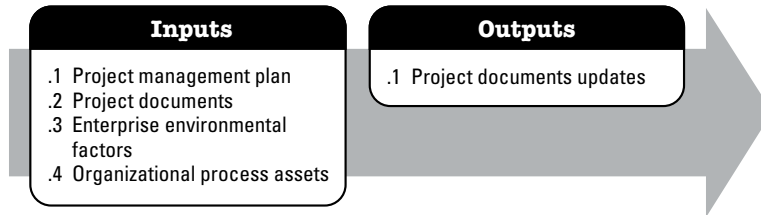

Figure 3-21. Perform Qualitative Risk Analysis: Inputs and Outputs

The needs of the project determine which components of the project management plan and which project documents are necessary.

3.20.1 PROJECT MANAGEMENT PLAN COMPONENTS

An example of a project management plan component that may be an input for this process includes but is not limited to the risk management plan.

3.20.2 PROJECT DOCUMENTS EXAMPLES

Examples of project documents that may be inputs for this process include but are not limited to:

- ◆ Assumption log,
- ◆ Risk register, and
- ◆ Stakeholder register.

3.20.3 PROJECT DOCUMENTS UPDATES

Project documents that may be updated as a result of this process include but are not limited to:

- ◆ Assumption log,
- ◆ Issue log,
- ◆ Risk register, and
- ◆ Risk report.

3.21 PERFORM QUANTITATIVE RISK ANALYSIS

Perform Quantitative Risk Analysis is the process of numerically analyzing the combined effect of identified individual project risks and other sources of uncertainty on overall project objectives. The key benefit of this process is that it quantifies overall project risk exposure and can also provide additional quantitative risk information to support risk response planning. This process is performed throughout the project. The inputs and outputs of this process are depicted in Figure 3-22.

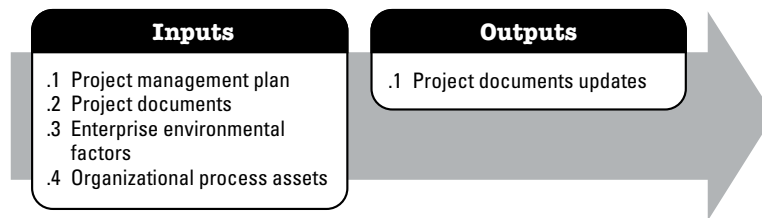

Figure 3-22. Perform Quantitative Risk Analysis: Inputs and Outputs

The needs of the project determine which components of the project management plan and which project documents are necessary.

3.21.1 PROJECT MANAGEMENT PLAN COMPONENTS

Examples of project management plan components that may be inputs for this process include but are not limited to:

- ◆ Risk management plan,
- ◆ Scope baseline,
- ◆ Schedule baseline, and
- ◆ Cost baseline.

3.21.2 PROJECT DOCUMENTS EXAMPLES

Examples of project documents that may be inputs for this process include but are not limited to:

- ◆ Assumption log,
- ◆ Basis of estimates,
- ◆ Cost estimates,
- ◆ Cost forecasts,
- ◆ Duration estimates,
- ◆ Milestone list,
- ◆ Resource requirements,
- ◆ Risk register,
- ◆ Risk report, and
- ◆ Schedule forecasts.

3.21.3 PROJECT DOCUMENTS UPDATES

Project documents that may be updated as a result of this process include but are not limited to the risk report.

3.22 PLAN RISK RESPONSES

Plan Risk Responses is the process of developing options, selecting strategies, and agreeing on actions to address overall project risk exposure as well as to treat individual project risks. The key benefit of this process is that it identifies appropriate ways to address overall project risk and individual project risks. This process also allocates resources and inserts activities into project documents and the project management plan as needed. This process is performed throughout the project. The inputs and outputs of this process are depicted in Figure 3-23.

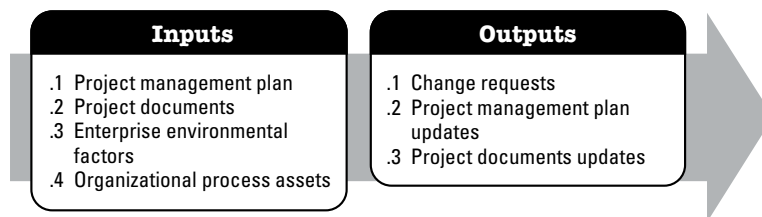

Figure 3-23. Plan Risk Responses: Inputs and Outputs

The needs of the project determine which components of the project management plan and which project documents are necessary.

3.22.1 PROJECT MANAGEMENT PLAN COMPONENTS

Examples of project management plan components that may be inputs for this process include but are not limited to:

- ◆ Resource management plan,
- ◆ Risk management plan, and
- ◆ Cost baseline.

3.22.2 PROJECT DOCUMENTS EXAMPLES

Examples of project documents that may be inputs for this process include but are not limited to:

- ◆ Lessons learned register,
- ◆ Project schedule,
- ◆ Project team assignments,
- ◆ Resource calendars,
- ◆ Risk register,
- ◆ Risk report, and
- ◆ Stakeholder register.

3.22.3 PROJECT MANAGEMENT PLAN UPDATES

Components of the project management plan that may be updated as a result of this process include but are not limited to:

- ◆ Schedule management plan,
- ◆ Cost management plan,
- ◆ Quality management plan,
- ◆ Resource management plan,
- ◆ Procurement management plan,
- ◆ Scope baseline,
- ◆ Schedule baseline, and
- ◆ Cost baseline.

3.22.4 PROJECT DOCUMENTS UPDATES

Project documents that may be updated as a result of this process include but are not limited to:

- ◆ Assumption log,
- ◆ Cost forecasts,
- ◆ Lessons learned register,
- ◆ Project schedule,
- ◆ Project team assignments,
- ◆ Risk register, and
- ◆ Risk report.

3.23 PLAN PROCUREMENT MANAGEMENT

Plan Procurement Management is the process of documenting project procurement decisions, specifying the approach, and identifying potential sellers. The key benefit of this process is that it determines whether to acquire goods and services from outside the project and, if so, what to acquire as well as how and when to acquire it. Goods and services may be procured from other parts of the performing organization or from external sources. This process is performed once or at predefined points in the project. The inputs and outputs of this process are depicted in Figure 3-24.

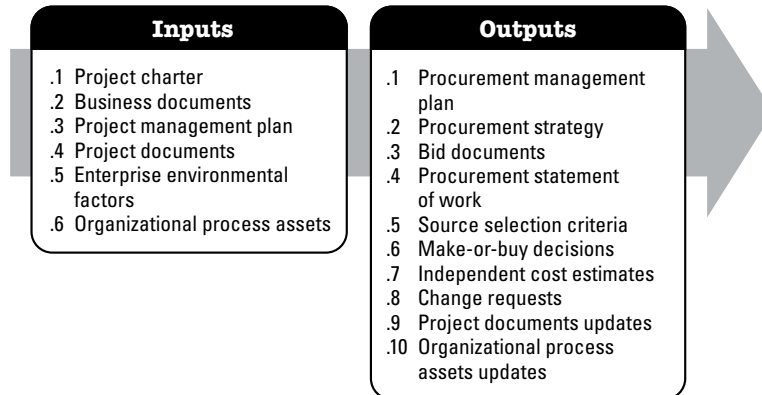

Figure 3-24. Plan Procurement Management: Inputs and Outputs

The needs of the project determine which components of the project management plan and which project documents are necessary.

3.23.1 PROJECT MANAGEMENT PLAN COMPONENTS

Examples of project management plan components that may be inputs for this process include but are not limited to:

- ◆ Scope management plan,
- ◆ Quality management plan,
- ◆ Resource management plan, and
- ◆ Scope baseline.

3.23.2 PROJECT DOCUMENTS EXAMPLES

Examples of project documents that may be inputs for this process include but are not limited to:

- ◆ Milestone list,
- ◆ Project team assignments,
- ◆ Requirements documentation,
- ◆ Requirements traceability matrix,
- ◆ Resource requirements,
- ◆ Risk register, and
- ◆ Stakeholder register.

3.23.3 PROJECT DOCUMENTS UPDATES

Project documents that may be updated as a result of this process include but are not limited to:

- ◆ Lessons learned register,
- ◆ Milestone list,
- ◆ Requirements documentation,
- ◆ Requirements traceability matrix,
- ◆ Risk register, and
- ◆ Stakeholder register.

3.24 PLAN STAKEHOLDER ENGAGEMENT

Plan Stakeholder Engagement is the process of developing approaches to involve project stakeholders based on their needs, expectations, interests, and potential impact on the project. The key benefit is that it provides an actionable plan to interact with stakeholders effectively. This process is performed periodically throughout the project as needed. The inputs and outputs of this process are depicted in Figure 3-25.

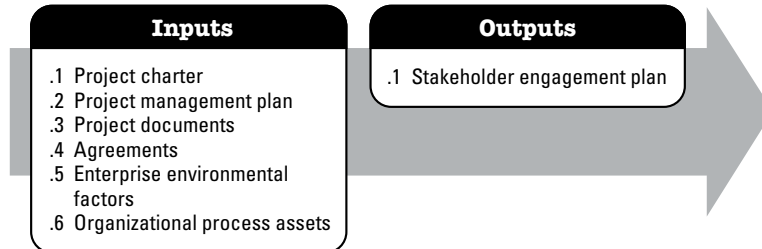

Figure 3-25. Plan Stakeholder Engagement: Inputs and Outputs

The needs of the project determine which components of the project management plan and which project documents are necessary.

3.24.1 PROJECT MANAGEMENT PLAN COMPONENTS

Examples of project management plan components that may be inputs for this process include but are not limited to:

- ◆ Resource management plan,
- ◆ Communications management plan, and
- ◆ Risk management plan.

3.24.2 PROJECT DOCUMENTS EXAMPLES

Examples of project documents that may be inputs for this process include but are not limited to:

- ◆ Assumption log,
- ◆ Change log,
- ◆ Issue log,
- ◆ Project schedule,
- ◆ Risk register, and
- ◆ Stakeholder register.

4

EXECUTING PROCESS GROUP

The Executing Process Group consists of those processes performed to complete the work defined in the project management plan to satisfy the project requirements. This Process Group involves coordinating resources, managing stakeholder engagement, and integrating and performing the activities of the project in accordance with the project management plan. The key benefit of this Process Group is that the work needed to meet the project requirements and objectives is performed according to plan. A large portion of the project budget, resources, and time is expended in performing the Executing Process Group processes. The processes in the Executing Process Group may generate change requests. If approved, the change requests may trigger one or more planning processes that result in a modified management plan, project documents, and possibly new baselines. The Executing Process Group (Figure 4-1) includes the project management processes identified in Sections 4.1 through 4.10.



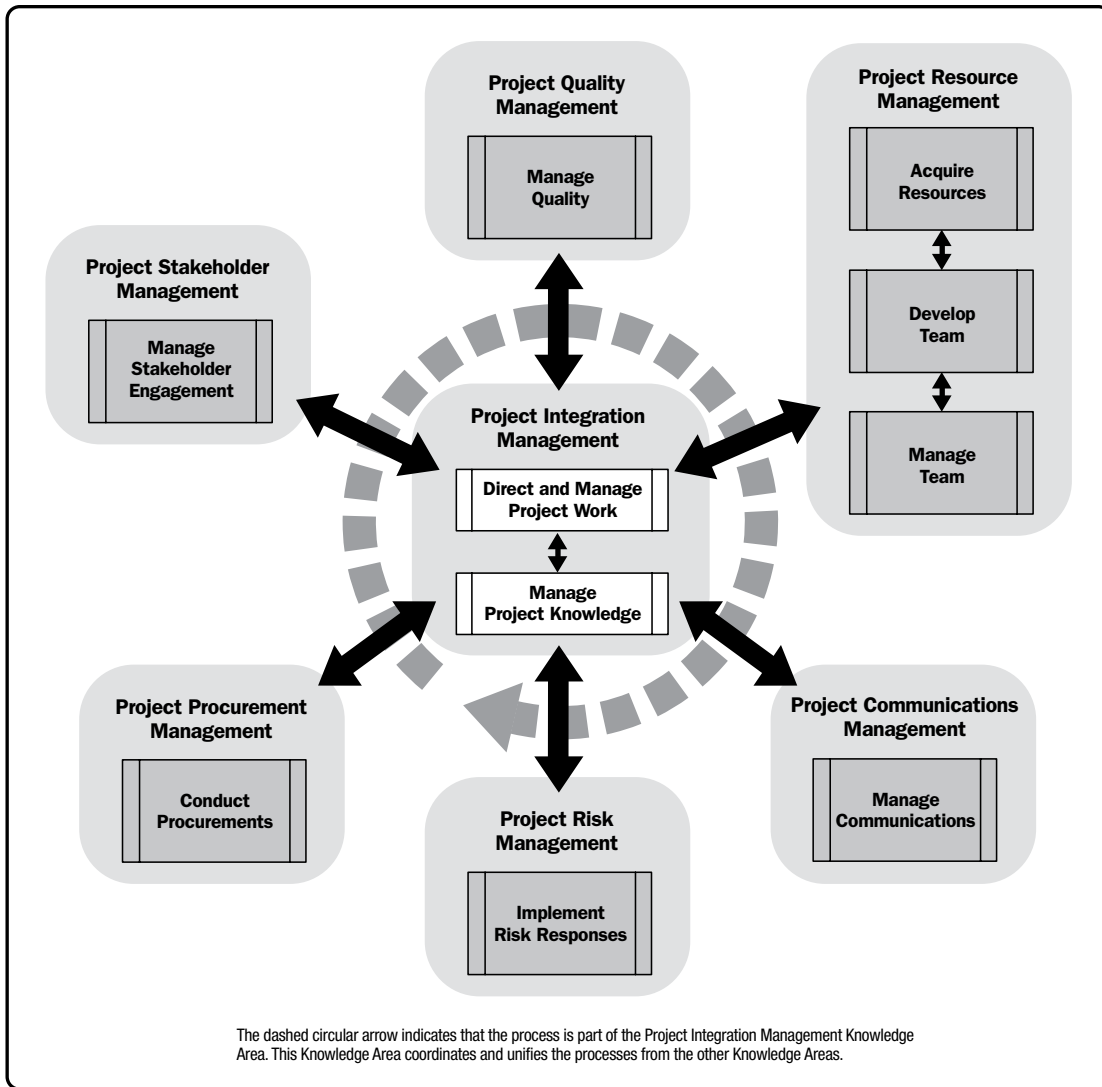

Figure 4-1. Executing Process Group

4.1 DIRECT AND MANAGE PROJECT WORK

Direct and Manage Project Work is the process of leading and performing the work defined in the project management plan and implementing approved changes to achieve the project's objectives. The key benefit of this process is that it provides overall management of the project work and deliverables, thus improving the probability of project success. This process is performed throughout the project. The inputs and outputs of this process are depicted in Figure 4-2.

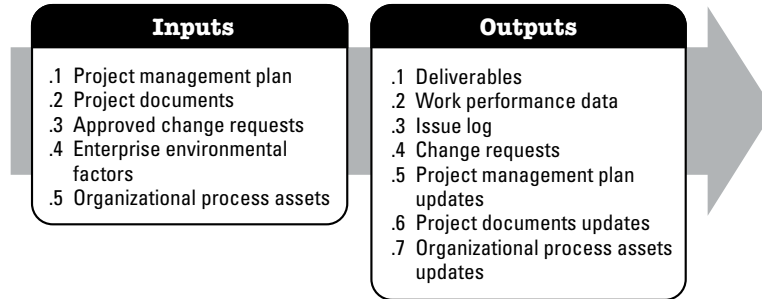

Figure 4-2. Direct and Manage Project Work: Inputs and Outputs

The needs of the project determine which components of the project management plan and which project documents are necessary.

4.1.1 PROJECT MANAGEMENT PLAN COMPONENTS

Any component of the project management plan may be an input for this process.

4.1.2 PROJECT DOCUMENTS EXAMPLES

Examples of project documents that may be inputs for this process include but are not limited to:

- ◆ Change log,
- ◆ Lessons learned register,
- ◆ Milestone list,
- ◆ Project communications,
- ◆ Project schedule,
- ◆ Requirements traceability matrix,
- ◆ Risk register, and
- ◆ Risk report.

4.1.3 PROJECT MANAGEMENT PLAN UPDATES

Any component of the project management plan may be updated as a result of this process.

4.1.4 PROJECT DOCUMENTS UPDATES

Project documents that may be updated as a result of this process include but are not limited to:

- ◆ Activity list,
- ◆ Assumption log,
- ◆ Lessons learned register,
- ◆ Requirements documentation,
- ◆ Risk register, and
- ◆ Stakeholder register.

4.2 MANAGE PROJECT KNOWLEDGE

Manage Project Knowledge is the process of using existing knowledge and creating new knowledge to achieve the project's objectives and contribute to organizational learning. The key benefits of this process are that prior organizational knowledge is leveraged to produce or improve the project outcomes and that knowledge created by the project is available to support organizational operations and future projects or phases. This process is performed throughout the project. The inputs and outputs of this process are depicted in Figure 4-3.

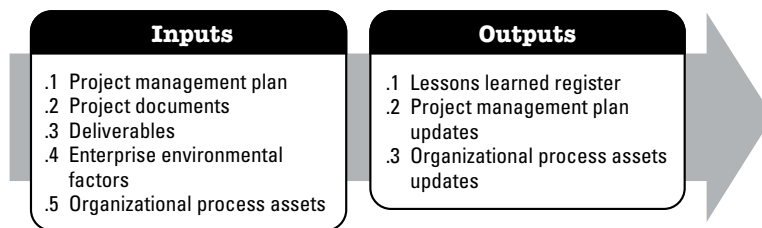

Figure 4-3. Manage Project Knowledge: Inputs and Outputs

The needs of the project determine which components of the project management plan and which project documents are necessary.

4.2.1 PROJECT MANAGEMENT PLAN COMPONENTS

All components of the project management plan may be inputs for this process.

4.2.2 PROJECT DOCUMENTS

Examples of project documents that may be inputs for this process include but are not limited to:

- ◆ Lessons learned register,
- ◆ Project team assignments,
- ◆ Resource breakdown structure,
- ◆ Source selection criteria, and
- ◆ Stakeholder register.

4.2.3 PROJECT MANAGEMENT PLAN UPDATES

Any component of the project management plan may be updated as a result of this process.

4.3 MANAGE QUALITY

Manage Quality is the process of translating the quality management plan into executable quality activities that incorporate the organization's quality policies into the project. The key benefit of this process is that it increases the probability of meeting the quality objectives, as well as identifying ineffective processes and causes of poor quality. This process is performed throughout the project. The inputs and outputs of this process are shown in Figure 4-4.

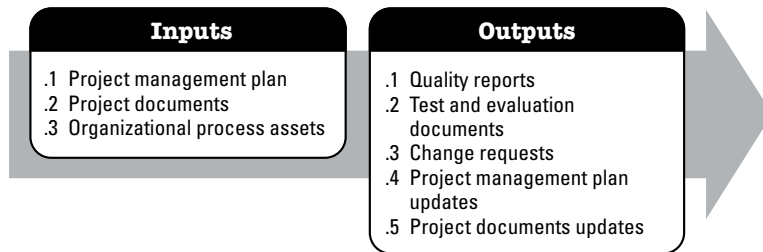

Figure 4-4. Manage Quality: Inputs and Outputs

The needs of the project determine which components of the project management plan and which project documents are necessary.

4.3.1 PROJECT MANAGEMENT PLAN COMPONENTS

An example of a project management plan component that may be an input for this process includes but is not limited to the quality management plan.

4.3.2 PROJECT DOCUMENTS EXAMPLES

Examples of project documents that may be inputs for this process include but are not limited to:

- ◆ Lessons learned register,
- ◆ Quality control measurements,
- ◆ Quality metrics, and
- ◆ Risk report.

4.3.3 PROJECT MANAGEMENT PLAN UPDATES

Components of the project management plan that may be updated as a result of this process include but are not limited to:

- ◆ Quality management plan,
- ◆ Scope baseline,
- ◆ Schedule baseline,
- ◆ Cost baseline.

4.3.4 PROJECT DOCUMENTS UPDATES

Project documents that may be updated as a result of this process include but are not limited to:

- ◆ Issue log,
- ◆ Lessons learned register, and
- ◆ Risk register.

4.4 ACQUIRE RESOURCES

Acquire Resources is the process of obtaining team members, facilities, equipment, materials, supplies, and other resources necessary to complete project work. The key benefit of this process is that it outlines and guides the selection of resources and assigns them to their respective activities. This process is performed periodically throughout the project as needed. The inputs and outputs of this process are shown in Figure 4-5.

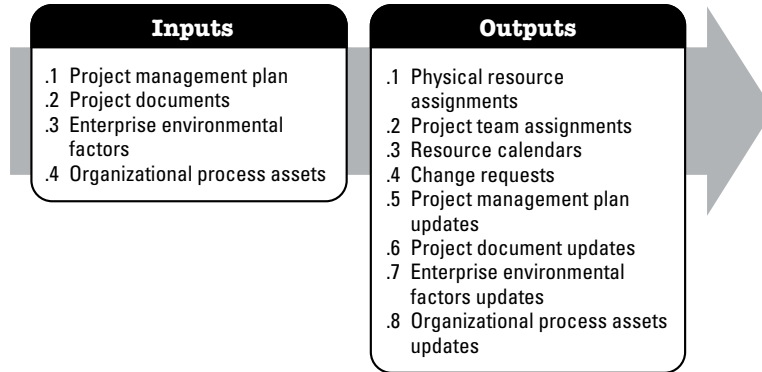

Figure 4-5. Acquire Resources: Inputs and Outputs

The needs of the project determine which components of the project management plan and which project documents are necessary.

4.4.1 PROJECT MANAGEMENT PLAN COMPONENTS

Examples of project management plan components that may be inputs for this process include but are not limited to:

- ◆ Resource management plan,
- ◆ Procurement management plan, and
- ◆ Cost baseline.

4.4.2 PROJECT DOCUMENTS EXAMPLES

Examples of project documents that may be inputs for this process include but are not limited to:

- ◆ Project schedule
- ◆ Resource calendars,
- ◆ Resource requirements, and
- ◆ Stakeholder register.

4.4.3 PROJECT MANAGEMENT PLAN UPDATES

Components of the project management plan that may be updated as a result of this process include but are not limited to:

- ◆ Resource management plan, and
- ◆ Cost baseline.

4.4.4 PROJECT DOCUMENTS UPDATES

Project documents that may be updated as a result of this process include but are not limited to:

- ◆ Lessons learned register,
- ◆ Project schedule,
- ◆ Resource breakdown structure,
- ◆ Resource calendars,
- ◆ Resource requirements,
- ◆ Risk register, and
- ◆ Stakeholder register.

4.5 DEVELOP TEAM

Develop Team is the process of improving competencies, team member interaction, and overall team environment to enhance project performance. The key benefit of this process is that it results in improved teamwork, enhanced interpersonal skills and competencies, motivated employees, reduced attrition, and improved overall project performance. This process is performed throughout the project. The inputs and outputs of this process are shown in Figure 4-6.

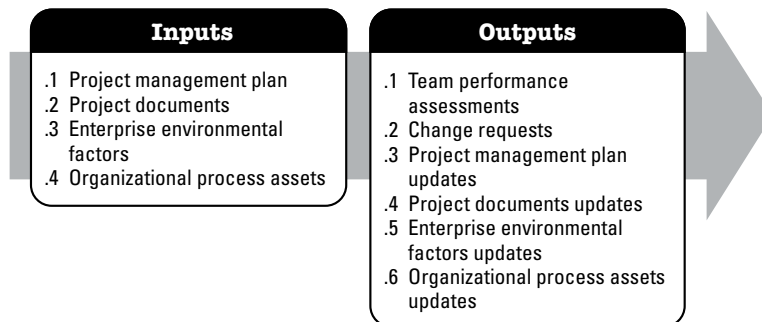

Figure 4-6. Develop Team: Inputs and Outputs

The needs of the project determine which components of the project management plan and which project documents are necessary.

4.5.1 PROJECT MANAGEMENT PLAN COMPONENTS

An example of a project management plan component that may be an input for this process includes but is not limited to the resource management plan.

4.5.2 PROJECT DOCUMENTS EXAMPLES

Examples of project documents that may be inputs for this process include but are not limited to:

- ◆ Lessons learned register,
- ◆ Project schedule,
- ◆ Project team assignments,
- ◆ Resource calendars, and
- ◆ Team charter.

4.5.3 PROJECT MANAGEMENT PLAN UPDATES

A component of the project management plan that may be updated as a result of this process includes but is not limited to the resource management plan.

4.5.4 PROJECT DOCUMENTS UPDATES

A project document that may be updated as a result of this process includes but is not limited to:

- ◆ Lessons learned register,
- ◆ Project schedule,
- ◆ Project team assignments,
- ◆ Resource calendars, and
- ◆ Team charter.

4.6 MANAGE TEAM

Manage Team is the process of tracking team member performance, providing feedback, resolving issues, and managing team changes to optimize project performance. The key benefit of this process is that it influences team behavior, manages conflict, and resolves issues. This process is performed throughout the project. The inputs and outputs of this process are shown in Figure 4-7.

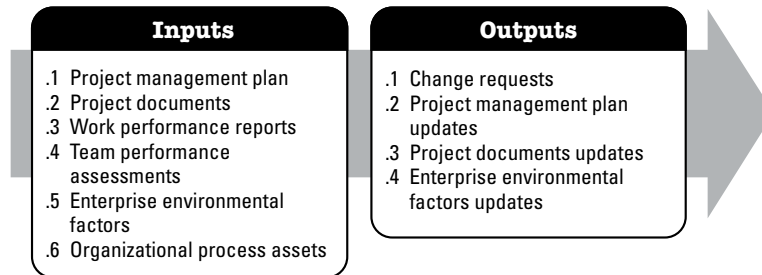

Figure 4-7. Manage Team: Inputs and Outputs

The needs of the project determine which components of the project management plan and which project documents are necessary.

4.6.1 PROJECT MANAGEMENT PLAN COMPONENTS

An example of a project management plan component that may be an input for this process includes but is not limited to the resource management plan.

4.6.2 PROJECT DOCUMENTS EXAMPLES

Examples of project documents that may be inputs for this process include but are not limited to:

- ◆ Issue log,
- ◆ Lessons learned register,
- ◆ Project team assignments, and
- ◆ Team charter.

4.6.3 PROJECT MANAGEMENT PLAN UPDATES

Components of the project management plan that may be updated as a result of this process include but are not limited to:

- ◆ Resource management plan,
- ◆ Schedule baseline, and
- ◆ Cost baseline.

4.6.4 PROJECT DOCUMENTS UPDATES

Project documents that may be updated as a result of this process include but are not limited to:

- ◆ Issue log,
- ◆ Lessons learned register, and
- ◆ Project team assignments.

4.7 MANAGE COMMUNICATIONS

Manage Communications is the process of ensuring timely and appropriate collection, creation, distribution, storage, retrieval, management, monitoring, and the ultimate disposition of project information. The key benefit of this process is that it enables an efficient and effective information flow between the project team and the stakeholders. This process is performed throughout the project. The inputs and outputs of this process are depicted in Figure 4-8.

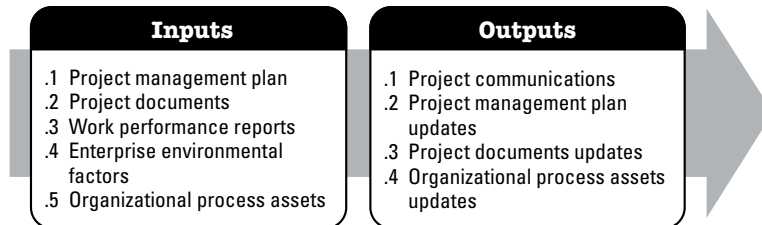

Figure 4-8. Manage Communications: Inputs and Outputs

The needs of the project determine which components of the project management plan and which project documents are necessary.

4.7.1 PROJECT MANAGEMENT PLAN COMPONENTS

Examples of project management plan components that may be inputs for this process include but are not limited to:

- ◆ Resource management plan,
- ◆ Communications management plan, and
- ◆ Stakeholder engagement plan.

4.7.2 PROJECT DOCUMENTS EXAMPLE

Examples of project documents that may be inputs for this process include but are not limited to:

- ◆ Change log,
- ◆ Issue log,
- ◆ Lessons learned register,
- ◆ Quality report,
- ◆ Risk report, and
- ◆ Stakeholder register.

4.7.3 PROJECT MANAGEMENT PLAN UPDATES

Examples of the project management plan components that may be updated as a result of this process include but are not limited to:

- ◆ Communications management plan, and
- ◆ Stakeholder engagement plan.

4.7.4 PROJECT DOCUMENTS UPDATES

Project documents that may be updated as a result of this process include but are not limited to:

- ◆ Issue log,
- ◆ Lessons learned register,
- ◆ Project schedule,
- ◆ Risk register, and
- ◆ Stakeholder register.

4.8 IMPLEMENT RISK RESPONSES

Implement Risk Responses is the process of implementing agreed-upon risk response plans. The key benefit of this process is that it ensures that agreed-upon risk responses are executed as planned in order to address overall project risk exposure, as well as to minimize individual project threats and maximize individual project opportunities. This process is performed throughout the project. The inputs and outputs of this process are depicted in Figure 4-9.

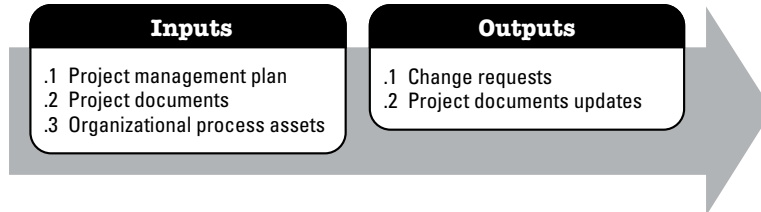

Figure 4-9. Implement Risk Responses: Inputs and Outputs

The needs of the project determine which components of the project management plan and which project documents are necessary.

4.8.1 PROJECT MANAGEMENT PLAN COMPONENTS

An example of a project management plan component that may be an input for this process includes but is not limited to the risk management plan.

4.8.2 PROJECT DOCUMENTS EXAMPLES

Examples of project documents that may be inputs for this process include but are not limited to:

- ◆ Lessons learned register,
- ◆ Risk register, and
- ◆ Risk report.

4.8.3 PROJECT DOCUMENTS UPDATES

Project documents that may be updated as a result of this process include but are not limited to:

- ◆ Issue log,
- ◆ Lessons learned register,
- ◆ Project team assignments,
- ◆ Risk register, and
- ◆ Risk report.

4.9 CONDUCT PROCUREMENTS

Conduct Procurements is the process of obtaining seller responses, selecting a seller, and awarding a contract. The key benefit of this process is that it selects a qualified seller and implements the legal agreement for delivery. This process is performed periodically throughout the project as needed. The inputs and outputs of this process are depicted in Figure 4-10.

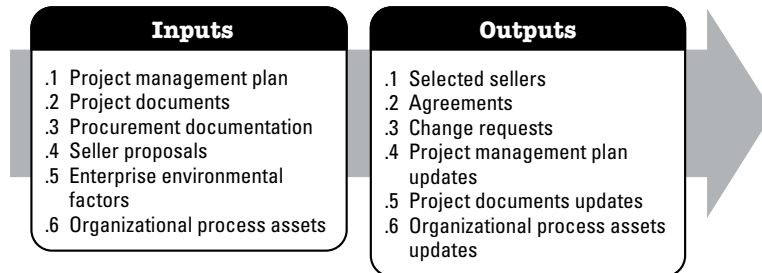

Figure 4-10. Conduct Procurements: Inputs and Outputs

The needs of the project determine which components of the project management plan and which project documents are necessary.

4.9.1 PROJECT MANAGEMENT PLAN COMPONENTS

Examples of project management plan components that may be inputs for this process include but are not limited to:

- ◆ Scope management plan,
- ◆ Requirements management plan,
- ◆ Communications management plan,
- ◆ Risk management plan,
- ◆ Procurement management plan,
- ◆ Configuration management plan, and
- ◆ Cost baseline.

4.9.2 PROJECT DOCUMENTS EXAMPLES

Examples of project documents that may be inputs for this process include but are not limited to:

- ◆ Lessons learned register,
- ◆ Project schedule,
- ◆ Requirements documentation,
- ◆ Risk register, and
- ◆ Stakeholder register.

4.9.3 PROJECT MANAGEMENT PLAN UPDATES

Components of the project management plan that may be updated as a result of this process include but are not limited to:

- ◆ Requirements management plan,
- ◆ Quality management plan,
- ◆ Communications management plan,
- ◆ Risk management plan,
- ◆ Procurement management plan,
- ◆ Scope baseline,
- ◆ Schedule baseline, and
- ◆ Cost baseline.

4.9.4 PROJECT DOCUMENTS UPDATES

Project documents that may be updated as a result of this process include but are not limited to:

- ◆ Lessons learned register,
- ◆ Requirements documentation,
- ◆ Requirements traceability matrix,
- ◆ Resource calendars,
- ◆ Risk register, and
- ◆ Stakeholder register.

4.10 MANAGE STAKEHOLDER ENGAGEMENT

Manage Stakeholder Engagement is the process of communicating and working with stakeholders to meet their needs and expectations, address issues, and foster appropriate stakeholder involvement. The key benefit of this process is that it allows the project manager to increase support and minimize resistance from stakeholders. This process is performed throughout the project. The inputs and outputs of this process are depicted in Figure 4-11.

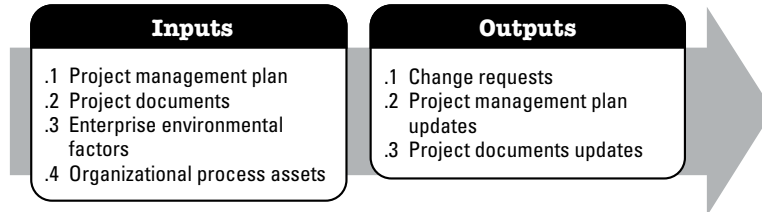

Figure 4-11. Manage Stakeholder Engagement: Inputs and Outputs

The needs of the project determine which components of the project management plan and which project documents are necessary.

4.10.1 PROJECT MANAGEMENT PLAN COMPONENTS

Examples of project management plan components that may be inputs for this process include but are not limited to:

- ◆ Communications management plan,
- ◆ Risk management plan,
- ◆ Stakeholder engagement plan, and
- ◆ Change management plan.

4.10.2 PROJECT DOCUMENTS EXAMPLES

Examples of project documents that may be inputs for this process include but are not limited to:

- ◆ Change log,
- ◆ Issue log,
- ◆ Lessons learned register, and
- ◆ Stakeholder register.

4.10.3 PROJECT MANAGEMENT PLAN UPDATES

Components of the project management plan that may be updated as a result of this process include but are not limited to:

- ◆ Communications management plan, and
- ◆ Stakeholder engagement plan.

4.10.4 PROJECT DOCUMENTS UPDATES

Project documents that may be updated as a result of this process include but are not limited to:

- ◆ Change log,
- ◆ Issue log,
- ◆ Lessons learned register, and
- ◆ Stakeholder register.





5

MONITORING AND CONTROLLING PROCESS GROUP

The Monitoring and Controlling Process Group consists of those processes required to track, review, and regulate the progress and performance of the project; identify any areas in which changes to the plan are required; and initiate the corresponding changes. Monitoring is collecting project performance data, producing performance measures, and reporting and disseminating performance information. Controlling is comparing actual performance with planned performance, analyzing variances, assessing trends to effect process improvements, evaluating possible alternatives, and recommending appropriate corrective action as needed. The key benefit of this Process Group is that project performance is measured and analyzed at regular intervals, appropriate events, or when exception conditions occur in order to identify and correct variances from the project management plan. The Monitoring and Controlling Process Group also involves:

- ◆ Evaluating change requests and deciding on the appropriate response;
- ◆ Recommending corrective or preventive action in anticipation of possible problems;
- ◆ Monitoring the ongoing project activities against the project management plan and project baselines; and
- ◆ Influencing the factors that could circumvent the change control process so only approved changes are implemented.

Continuous monitoring provides the project team and other stakeholders with insight into the status of the project and identifies any areas that require additional attention. The Monitoring and Controlling Process Group monitors and controls the work being done within each Knowledge Area, each Process Group, each life cycle phase, and the project as a whole. The Monitoring and Controlling Process Group (Figure 5-1) includes the project management processes identified in Sections 5.1 through 5.12.

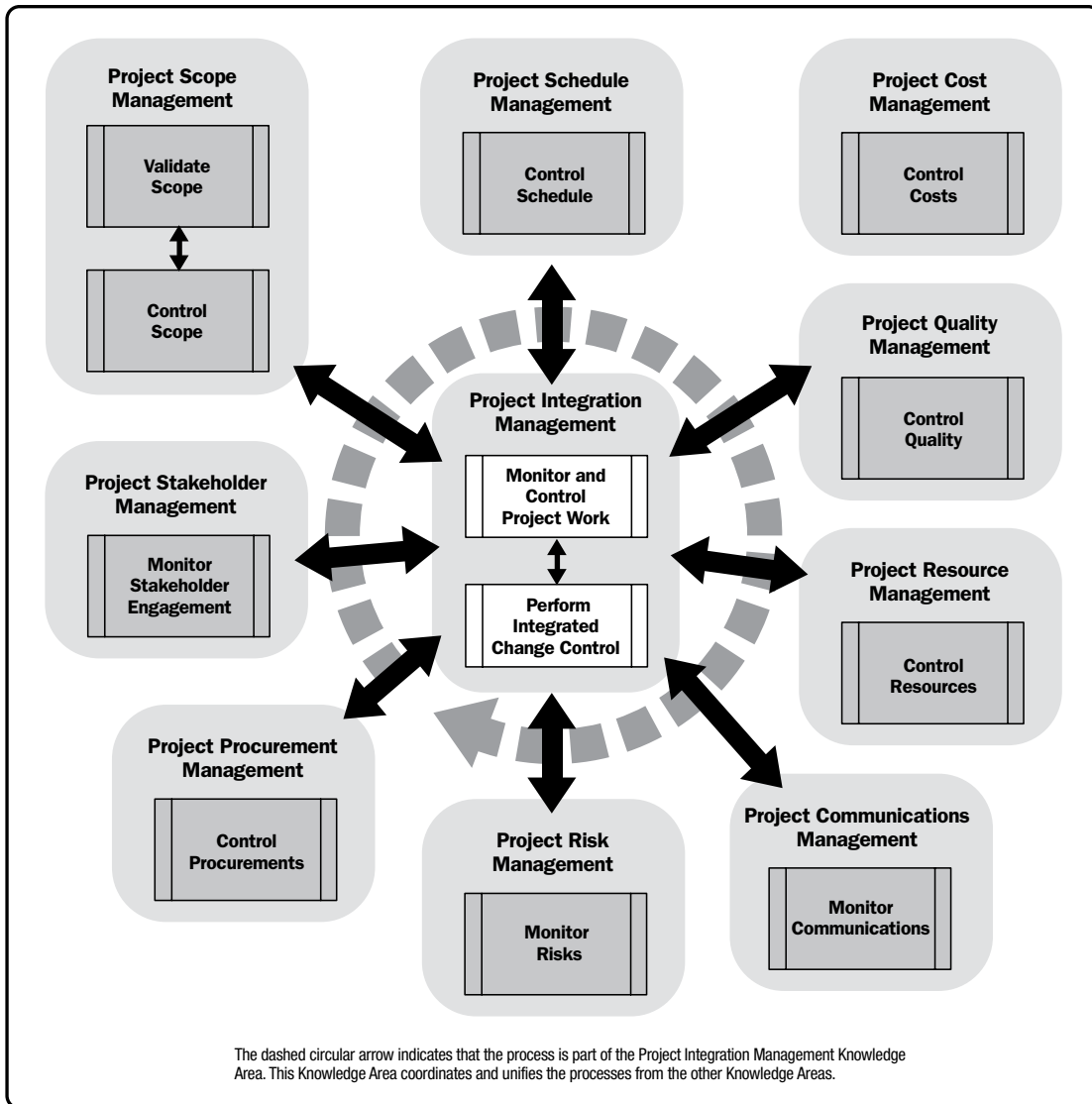

Figure 5-1. Monitoring and Controlling Process Group

5.1 MONITOR AND CONTROL PROJECT WORK

Monitor and Control Project Work is the process of tracking, reviewing, and reporting the overall progress to meet the performance objectives defined in the project management plan. The key benefit of this process is that it allows stakeholders to understand the current state of the project, to recognize the actions taken to address any performance issues, and to have visibility into the future project status with cost and schedule forecasts. This process is performed throughout the project. The inputs and outputs for this process are depicted in Figure 5-2.

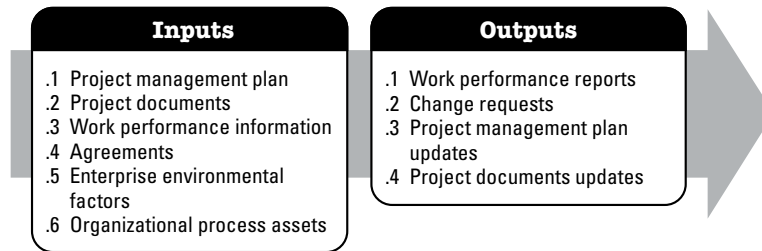

Figure 5-2. Monitor and Control Project Work: Inputs and Outputs

The needs of the project determine which components of the project management plan and which project documents are necessary.

5.1.1 PROJECT MANAGEMENT PLAN COMPONENTS

Any component of the project management plan may be an input for this process.

5.1.2 PROJECT DOCUMENTS EXAMPLES

Examples of project documents that may be inputs for this process include but are not limited to:

- ◆ Assumption log,
- ◆ Basis of estimates,
- ◆ Cost forecasts,
- ◆ Issue log,
- ◆ Lessons learned register,
- ◆ Milestone list,
- ◆ Quality reports,
- ◆ Risk register,
- ◆ Risk report, and
- ◆ Schedule forecasts.

5.1.3 PROJECT MANAGEMENT PLAN UPDATES

Any component of the project management plan may be updated as a result of this process.

5.1.4 PROJECT DOCUMENTS UPDATES

Project documents that may be updated as a result of this process include but are not limited to:

- ◆ Cost forecasts,
- ◆ Issue log,
- ◆ Lessons learned register,
- ◆ Risk register, and
- ◆ Schedule forecasts.

5.2 PERFORM INTEGRATED CHANGE CONTROL

Perform Integrated Change Control is the process of reviewing all change requests; approving changes and managing changes to deliverables, organizational process assets, project documents, and the project management plan; and communicating the decisions. This process reviews all requests for changes to project documents, deliverables, or the project management plan, and determines the resolution of the change requests. The key benefit of this process is that it allows for documented changes within the project to be considered in an integrated manner while addressing overall project risk, which often arises from changes made without consideration of the overall project objectives or plans. This process is performed throughout the project. The inputs and outputs of this process are depicted in Figure 5-3.

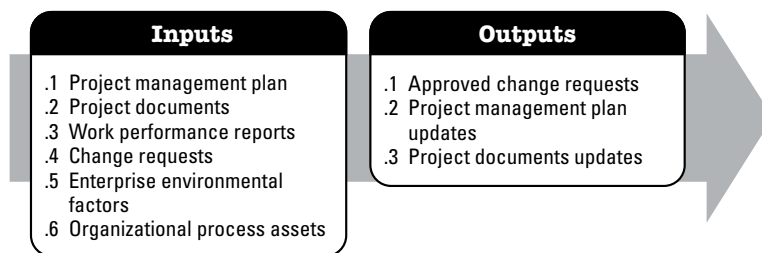

Figure 5-3. Perform Integrated Change Control: Inputs and Outputs

The needs of the project determine which components of the project management plan and which project documents are necessary.

5.2.1 PROJECT MANAGEMENT PLAN COMPONENTS

Examples of project management plan components that may be inputs for this process include but are not limited to:

- ◆ Change management plan,
- ◆ Configuration management plan,
- ◆ Scope baseline,
- ◆ Schedule baseline, and
- ◆ Cost baseline.

5.2.2 PROJECT DOCUMENTS EXAMPLES

Examples of project documents that may be inputs for this process include but are not limited to:

- ◆ Basis of estimates,
- ◆ Requirements traceability matrix, and
- ◆ Risk report.

5.2.3 PROJECT MANAGEMENT PLAN UPDATES

Any component of the project management plan may be updated as a result of this process.

5.2.4 PROJECT DOCUMENTS UPDATES

Any formally controlled project document may be changed as a result of this process. A project document that is normally updated as a result of this process is the change log. The change log is used to document changes that occur during a project.



5.3 VALIDATE SCOPE

Validate Scope is the process of formalizing acceptance of the completed project deliverables. The key benefit of this process is that it brings objectivity to the acceptance process and increases the probability of final product, service, or result acceptance by validating each deliverable. This process is performed periodically throughout the project as needed. The inputs and outputs of this process are depicted in Figure 5-4.

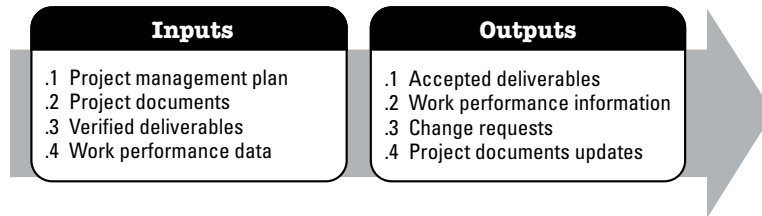

Figure 5-4. Validate Scope: Inputs and Outputs

The needs of the project determine which components of the project management plan and which project documents are necessary.

5.3.1 PROJECT MANAGEMENT PLAN COMPONENTS

Examples of project management plan components that may be inputs for this process include but are not limited to:

- ◆ Scope management plan,
- ◆ Requirements management plan, and
- ◆ Scope baseline.

5.3.2 PROJECT DOCUMENTS EXAMPLES

Examples of project documents that may be inputs for this process include but are not limited to:

- ◆ Lessons learned register,
- ◆ Quality reports,
- ◆ Requirements documentation, and
- ◆ Requirements traceability matrix.

5.3.3 PROJECT DOCUMENTS UPDATES

Examples of project documents that may be updated as a result of this process include but are not limited to:

- ◆ Lessons learned register,
- ◆ Requirements documentation, and
- ◆ Requirements traceability matrix.

5.4 CONTROL SCOPE

Control Scope is the process of monitoring the status of the project and product scope and managing changes to the scope baseline. The key benefit of this process is that the scope baseline is maintained throughout the project. This process is performed throughout the project. The inputs and outputs of this process are depicted in Figure 5-5.

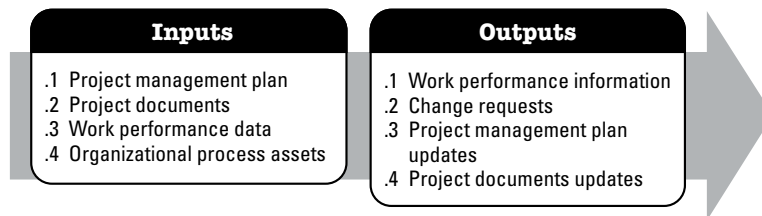

Figure 5-5. Control Scope: Inputs and Outputs

The needs of the project determine which components of the project management plan and which project documents are necessary.

5.4.1 PROJECT MANAGEMENT PLAN COMPONENTS

Examples of project management plan components that may be inputs for this process include but are not limited to:

- ◆ Scope management plan,
- ◆ Requirements management plan,
- ◆ Change management plan,
- ◆ Configuration management plan,
- ◆ Scope baseline, and
- ◆ Performance measurement baseline.

5.4.2 PROJECT DOCUMENTS EXAMPLES

Examples of project documents that may be inputs for this process include but are not limited to:

- ◆ Lessons learned register,
- ◆ Requirements documentation, and
- ◆ Requirements traceability matrix.

5.4.3 PROJECT MANAGEMENT PLAN UPDATES

Components of the project management plan that may be updated as a result of this process include but are not limited to:

- ◆ Scope management plan,
- ◆ Scope baseline,
- ◆ Schedule baseline,
- ◆ Cost baseline and
- ◆ Performance measurement baseline.

5.4.4 PROJECT DOCUMENTS UPDATES

Project documents that may be updated as a result of this process include but are not limited to:

- ◆ Lessons learned register,
- ◆ Requirements documentation, and
- ◆ Requirements traceability matrix.

5.5 CONTROL SCHEDULE

Control Schedule is the process of monitoring the status of the project to update the project schedule and manage changes to the schedule baseline. The key benefit of this process is that the schedule baseline is maintained throughout the project. This process is performed throughout the project. The inputs and outputs of this process are depicted in Figure 5-6.

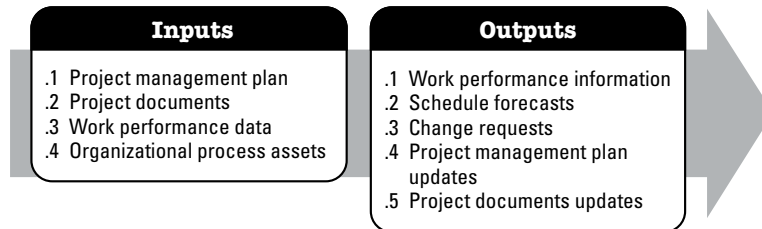

Figure 5-6. Control Schedule: Inputs and Outputs

The needs of the project determine which components of the project management plan and which project documents are necessary.

5.5.1 PROJECT MANAGEMENT PLAN COMPONENTS

Examples of project management plan components that may be inputs for this process include but are not limited to:

- ◆ Schedule management plan,
- ◆ Schedule baseline,
- ◆ Scope baseline, and
- ◆ Performance measurement baseline.

5.5.2 PROJECT DOCUMENTS EXAMPLES

Examples of project documents that may be inputs for this process include but are not limited to:

- ◆ Lessons learned register,
- ◆ Project calendars,
- ◆ Project schedule,
- ◆ Resource calendars, and
- ◆ Schedule data.

5.5.3 PROJECT MANAGEMENT PLAN UPDATES

Components of the project management plan that may be updated as a result of this process include but are not limited to:

- ◆ Schedule management plan,
- ◆ Schedule baseline, and
- ◆ Cost baseline and
- ◆ Performance measurement baseline.

5.5.4 PROJECT DOCUMENTS UPDATES

Project documents that may be updated as a result of this process include but are not limited to:

- ◆ Assumption log,
- ◆ Basis of estimates,
- ◆ Lessons learned register,
- ◆ Project schedule,
- ◆ Resource calendars,
- ◆ Risk register, and
- ◆ Schedule data.

5.6 CONTROL COSTS

Control Costs is the process of monitoring the status of the project to update the project costs and managing changes to the cost baseline. The key benefit of this process is that the cost baseline is maintained throughout the project. This process is performed throughout the project. The inputs and outputs of this process are depicted in Figure 5-7.

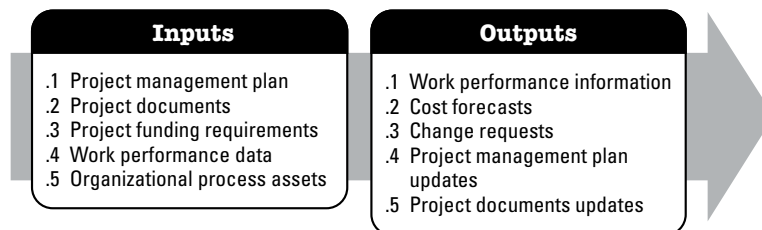

Figure 5-7. Control Costs: Inputs and Outputs

The needs of the project determine which components of the project management plan are necessary.

5.6.1 PROJECT MANAGEMENT PLAN COMPONENTS

Examples of project management plan components that may be inputs for this process include but are not limited to:

- ◆ Cost management plan,
- ◆ Cost baseline, and
- ◆ Performance measurement baseline.

5.6.2 PROJECT DOCUMENTS EXAMPLES

An example of a project document that may be an input for this process includes but is not limited to the lessons learned register.

5.6.3 PROJECT MANAGEMENT PLAN UPDATES

Components of the project management plan that may be updated as a result of this process include but are not limited to:

- ◆ Cost management plan,
- ◆ Cost baseline, and
- ◆ Performance measurement baseline.

5.6.4 PROJECT DOCUMENTS UPDATES

Project documents that may be updated as a result of this process include but are not limited to:

- ◆ Assumption log,
- ◆ Basis of estimates,
- ◆ Cost estimates,
- ◆ Lessons learned register, and
- ◆ Risk register.

5.7 CONTROL QUALITY

Control Quality is the process of monitoring and recording results of executing the quality management activities to assess performance and ensure the project outputs are complete, correct, and meet customer expectations. The key benefit of this process is verifying that project deliverables and work meet the requirements specified by key stakeholders for final acceptance. This process is performed throughout the project. The inputs and outputs of this process are shown in Figure 5-8.

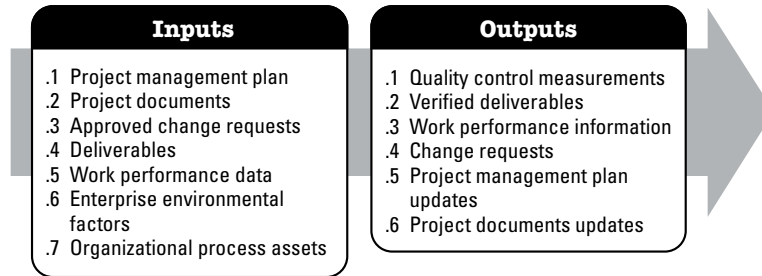

Figure 5-8. Control Quality: Inputs and Outputs

The needs of the project determine which components of the project management plan and which project documents are necessary.

5.7.1 PROJECT MANAGEMENT PLAN COMPONENTS

An example of a project management plan component that may be an input for this process includes but is not limited to the quality management plan.

5.7.2 PROJECT DOCUMENTS EXAMPLES

Examples of project documents that may be inputs for this process include but are not limited to:

- ◆ Lessons learned register,
- ◆ Quality metrics, and
- ◆ Test and evaluation documents.

5.7.3 PROJECT MANAGEMENT PLAN UPDATES

A component of the project management plan that may be updated as a result of this process includes but is not limited to the quality management plan.

5.7.4 PROJECT DOCUMENTS UPDATES

Project documents that may be updated as a result of this process include but are not limited to:

- ◆ Issue log,
- ◆ Lessons learned register,
- ◆ Risk register, and
- ◆ Test and evaluation documents.

5.8 CONTROL RESOURCES

Control Resources is the process of ensuring that the physical resources assigned and allocated to the project are available as planned, as well as monitoring the planned versus actual utilization of resources and taking corrective action as necessary. The key benefit of this process is ensuring that the assigned resources are available to the project at the right time and in the right place and are released when no longer needed. This process is performed throughout the project. The inputs and outputs of this process are shown in Figure 5-9.

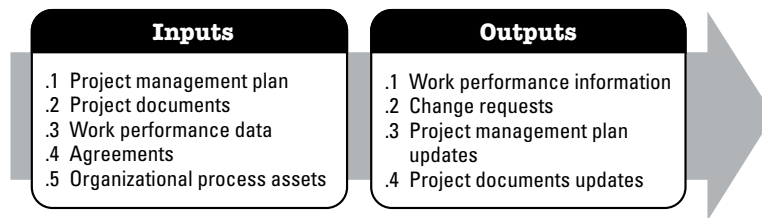

Figure 5-9. Control Resources: Inputs and Outputs

The needs of the project determine which components of the project management plan and which project documents are necessary.

5.8.1 PROJECT MANAGEMENT PLAN COMPONENTS

An example of a project management plan component that may be an input for this process includes but is not limited to the resource management plan.

5.8.2 PROJECT DOCUMENTS EXAMPLES

Examples of project documents that may be inputs for this process include but are not limited to:

- ◆ Issue log,
- ◆ Lessons learned register,
- ◆ Physical resource assignments,
- ◆ Project schedule
- ◆ Resource breakdown structure,
- ◆ Resource requirements, and
- ◆ Risk register.

5.8.3 PROJECT MANAGEMENT PLAN UPDATES

A component of the project management plan that may be updated as a result of this process includes but is not limited to:

- ◆ Resource management plan,
- ◆ Schedule baseline, and
- ◆ Cost baseline.

5.8.4 PROJECT DOCUMENTS UPDATES

Project documents that may be updated as a result of this process include but are not limited to:

- ◆ Assumption log,
- ◆ Issue log,
- ◆ Lessons learned register,
- ◆ Physical resource assignments,
- ◆ Resource breakdown structure, and
- ◆ Risk register.

5.9 MONITOR COMMUNICATIONS

Monitor Communications is the process of ensuring the information needs of the project and its stakeholders are met. The key benefit of this process is the optimal information flow as defined in the communications management plan and stakeholder engagement plan. This process is performed throughout the project. The inputs and outputs of this process are depicted in Figure 5-10.

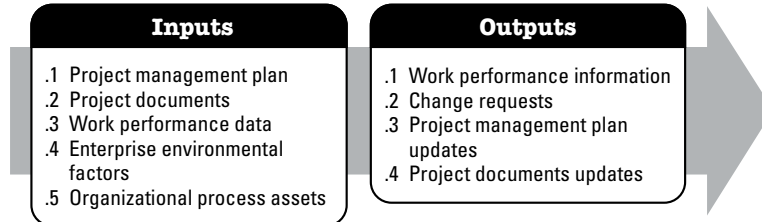

Figure 5-10. Monitor Communications: Inputs and Outputs

The needs of the project determine which components of the project management plan and which project documents are necessary.

5.9.1 PROJECT MANAGEMENT PLAN COMPONENTS

Examples of project management plan components that may be inputs for this process include but are not limited to:

- ◆ Resource management plan,
- ◆ Communications management plan, and
- ◆ Stakeholder engagement plan.

5.9.2 PROJECT DOCUMENTS EXAMPLES

Examples of project documents that may be inputs for this process include but are not limited to:

- ◆ Issue log,
- ◆ Lessons learned register, and
- ◆ Project communications.

5.9.3 PROJECT MANAGEMENT PLAN UPDATES

Components of the project management plan that may be updated as a result of this process include but are not limited to:

- ◆ Communications management plan, and
- ◆ Stakeholder engagement plan.

5.9.4 PROJECT DOCUMENTS UPDATES

Project documents that may be updated as a result of this process include but are not limited to:

- ◆ Issue log,
- ◆ Lessons learned register, and
- ◆ Stakeholder register.

5.10 MONITOR RISKS

Monitor Risks is the process of monitoring the implementation of agreed-upon risk response plans, tracking identified risks, identifying and analyzing new risks, and evaluating risk process effectiveness throughout the project. The key benefit of this process is that it enables project decisions to be based on current information about overall project risk exposure and individual project risks. This process is performed throughout the project. The inputs and outputs of this process are depicted in Figure 5-11.

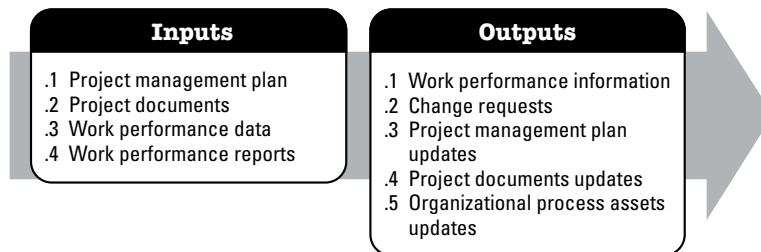

Figure 5-11. Monitor Risks: Inputs and Outputs

The needs of the project determine which components of the project management plan and which project documents are necessary.

5.10.1 PROJECT MANAGEMENT PLAN COMPONENTS

An example of a project management plan component that may be an input for this process includes but is not limited to the risk management plan.

5.10.2 PROJECT DOCUMENTS EXAMPLES

Examples of project documents that may be inputs for this process include but are not limited to:

- ◆ Issue log,
- ◆ Lessons learned register,
- ◆ Risk register, and
- ◆ Risk report.

5.10.3 PROJECT MANAGEMENT PLAN UPDATES

Any component of the project management plan may be updated as a result of this process.

5.10.4 PROJECT DOCUMENTS UPDATES

Project documents that may be updated as a result of this process include but are not limited to:

- ◆ Assumption log,
- ◆ Issue log,
- ◆ Lessons learned register,
- ◆ Risk register, and
- ◆ Risk report.



5.11 CONTROL PROCUREMENTS

Control Procurements is the process of managing procurement relationships, monitoring contract performance and making changes and corrections as appropriate, and closing out contracts. The key benefit of this process is that it ensures that both the seller's and buyer's performance meets the project's requirements according to the terms of the legal agreements. This process is performed throughout the project, when procurements are active. The inputs and outputs of this process are depicted in Figure 5-12.

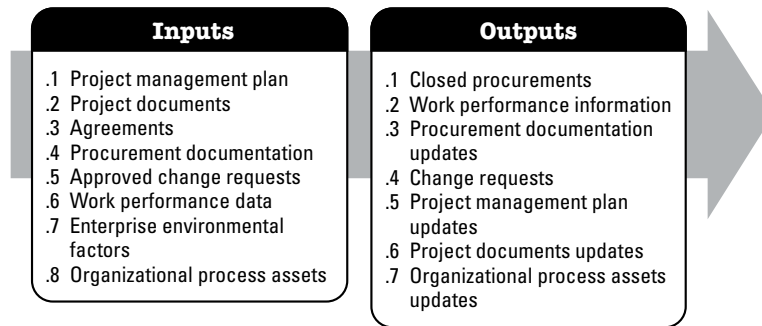

Figure 5-12. Control Procurements: Inputs and Outputs

The needs of the project determine which components of the project management plan and which project documents are necessary.

5.11.1 PROJECT MANAGEMENT PLAN COMPONENTS

Examples of project management plan components that may be inputs for this process include but are not limited to:

- ◆ Requirements management plan,
- ◆ Risk management plan,
- ◆ Procurement management plan,
- ◆ Change management plan, and
- ◆ Schedule baseline.

5.11.2 PROJECT DOCUMENTS EXAMPLES

Examples of project documents that may be inputs for this process include but are not limited to:

- ◆ Assumption log,
- ◆ Lessons learned register,
- ◆ Milestone list,
- ◆ Quality reports,
- ◆ Requirements documentation,
- ◆ Requirements traceability matrix,
- ◆ Risk register, and
- ◆ Stakeholder register.

5.11.3 PROJECT MANAGEMENT PLAN UPDATES

Components of the project management plan that may be updated as a result of this process include but are not limited to:

- ◆ Risk management plan,
- ◆ Procurement management plan,
- ◆ Schedule baseline, and
- ◆ Cost baseline.

5.11.4 PROJECT DOCUMENTS UPDATES

Project documents that may be updated as a result of this process include but are not limited to:

- ◆ Lessons learned register,
- ◆ Resource requirements,
- ◆ Requirements traceability matrix,
- ◆ Risk register, and
- ◆ Stakeholder register.

5.12 MONITOR STAKEHOLDER ENGAGEMENT

Monitor Stakeholder Engagement is the process of monitoring project stakeholder relationships, and tailoring strategies for engaging stakeholders through modification of engagement strategies and plans. The key benefit of this process is that it maintains or increases the efficiency and effectiveness of stakeholder engagement activities as the project evolves and its environment changes. This process is performed throughout the project. The inputs and outputs of this process are depicted in Figure 5-13.

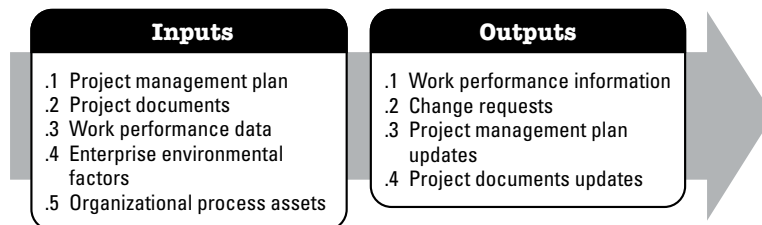

Figure 5-13. Monitor Stakeholder Engagement: Inputs and Outputs

The needs of the project determine which components of the project management plan and which project documents are necessary.

5.12.1 PROJECT MANAGEMENT PLAN COMPONENTS

Examples of project management plan components that may be inputs for this process include but are not limited to:

- ◆ Resource management plan,
- ◆ Communications management plan, and
- ◆ Stakeholder engagement plan.

5.12.2 PROJECT DOCUMENTS EXAMPLES

Examples of project documents that may be inputs for this process include but are not limited to:

- ◆ Issue log,
- ◆ Lessons learned register,
- ◆ Project communications,
- ◆ Risk register, and
- ◆ Stakeholder register.

5.12.3 PROJECT MANAGEMENT PLAN UPDATES

Components of the project management plan that may be updated as a result of this process include but are not limited to:

- ◆ Resource management plan,
- ◆ Communications management plan, and
- ◆ Stakeholder engagement plan.

5.12.4 PROJECT DOCUMENTS UPDATES

Project documents that may be updated as a result of this process include but are not limited to:

- ◆ Issue log,
- ◆ Lessons learned register,
- ◆ Risk register, and
- ◆ Stakeholder register.

6

CLOSING PROCESS GROUP

The Closing Process Group consists of the process(es) performed to formally complete or close a project, phase, or contract. This Process Group verifies that the defined processes are completed within all of the Process Groups to close the project or phase, as appropriate, and formally establishes that the project or project phase is complete. The key benefit of this Process Group is that phases, projects, and contracts are closed out appropriately. While there is only one process in this Process Group, organizations may have their own processes associated with project, phase, or contract closure. Therefore, the term Process Group is maintained.

This Process Group may also address the early closure of the project, for example, aborted projects or cancelled projects.

The Closing Process Group (Figure 6-1) includes the project management process identified in Section 6.1.

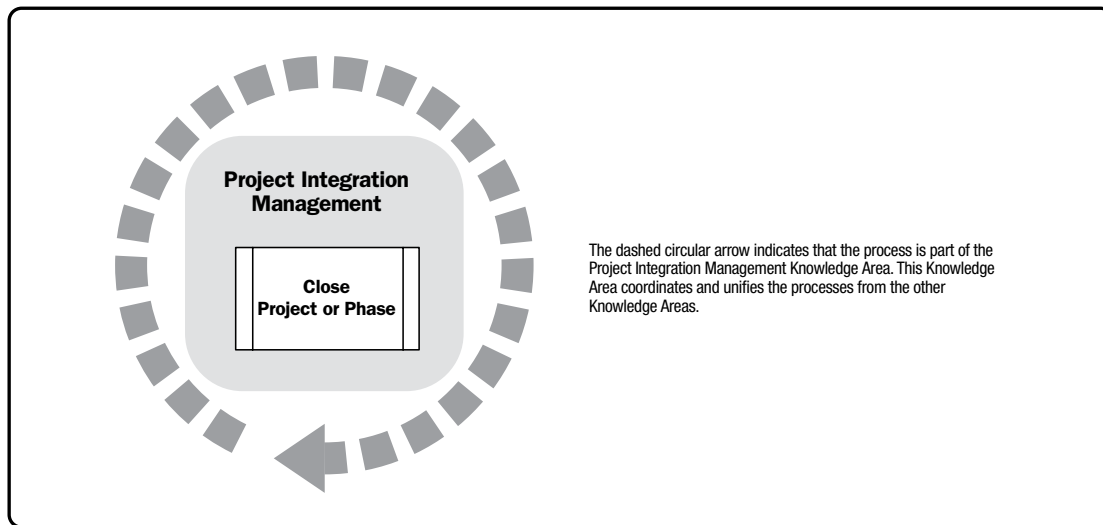

Figure 6-1. Closing Process Group

6.1 CLOSE PROJECT OR PHASE

Close Project or Phase is the process of finalizing all activities for the project, phase, or contract. The key benefits of this process are the project or phase information is archived, the planned work is completed, and organizational resources are released to pursue new endeavors. This process is performed once or at predefined points in the project. The inputs and outputs of this process are depicted in Figure 6-2.

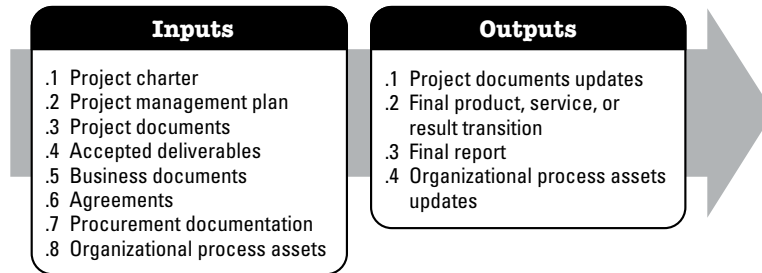

Figure 6-2. Close Project or Phase: Inputs and Outputs

The needs of the project determine which components of the project management plan and which project documents are necessary.

6.1.1 PROJECT MANAGEMENT PLAN COMPONENTS

All components of the project management plan may be inputs to this process.

6.1.2 PROJECT DOCUMENTS EXAMPLES

Examples of project documents that may be inputs for this process include but are not limited to:

- ◆ Assumption log,
- ◆ Basis of estimates,
- ◆ Change log,
- ◆ Issue log,
- ◆ Lessons learned register,
- ◆ Milestone list,
- ◆ Project communications,
- ◆ Quality control measurements,
- ◆ Quality reports,
- ◆ Requirements documentation,
- ◆ Risk register, and
- ◆ Risk report.

6.1.3 PROJECT DOCUMENTS UPDATES

Any project documents that may be updated as a result of this process include but are not limited to the lessons learned register.



Part 3

Appendices, Glossary, and Index

The information contained in this part is not an American National Standard (ANS) and has not been processed in accordance with ANSI's requirements for an ANS. As such, the information in this part may contain material that has not been subjected to public review or a consensus process. In addition, it does not contain requirements necessary for conformance to an ANS standard.

APPENDIX X1

SIXTH EDITION CHANGES

The purpose of this appendix is to provide an overview of the changes made to *A Guide to the Project Management Body of Knowledge (PMBOK® Guide)*—Fifth Edition to create the *PMBOK® Guide*—Sixth Edition.

X1.1 SCOPE OF UPDATE

The approved scope for the *PMBOK® Guide*—Sixth Edition includes:

- ◆ Review the following and determine whether the material will be included or excluded in the new editions, and track the disposition:
 - All material relevant to Sections 1 through 13, Annex A1, and the Glossary that was deferred during the development of *A Guide to the Project Management Body of Knowledge (PMBOK® Guide)*—Fifth Edition
 - All comments and feedback relevant to Sections 1 through 13, Annex A1, and the Glossary of *A Guide to the Project Management Body of Knowledge (PMBOK® Guide)*—Fifth Edition that have been received by PMI since the initial development and publication.
- ◆ Review, interpret, and ensure appropriate alignment with ISO 21500 in the development of the standard.
- ◆ Ensure harmonization with any other relevant PMI foundational standards.
- ◆ Consider the project manager role delineation study results and other PMI research studies for incorporation as appropriate.
- ◆ Review, conduct, and analyze research for significant additions, deletions, and changes to the Sixth Edition and possibly for strategic input to future editions.

With that directive in mind, the update team focused on bringing greater consistency and clarity by refining and standardizing the processes, inputs, tools and techniques, and outputs.

X1.2 RULES FOR HARMONIZATION BETWEEN GLOSSARY TERMS AND THE *PMI LEXICON OF PROJECT MANAGEMENT TERMS*

To ensure that terms used in the *PMBOK® Guide* align with the *PMI Lexicon of Project Management Terms*¹ and harmonize with other relevant PMI standards, the Sixth Edition followed these business rules:

- ◆ For terms found in both the *PMBOK® Guide* and the *PMI Lexicon*, the definition from the *PMI Lexicon* is used.
- ◆ Where terms used in the *PMBOK® Guide* are not found in the *PMI Lexicon* but are found in other relevant PMI standards, the definitions of the terms should be identical. If the definitions do not align with the respective standards, the term is elevated to the PMI Lexicon team for assistance in creating an acceptable common definition.

X1.3 RULES FOR HANDLING INPUTS AND OUTPUTS

The following business rules were used to provide consistency in the order and information within the inputs and outputs for each project management process:

- ◆ *Fundamental Rules:*
 - Inputs are any documents that are key to the process.
 - Outputs should become an input to another project management process unless the output is a terminal output or embedded within another input such as project documents.
 - Inputs should come from an output from another project management process unless the input comes from outside the project.
- ◆ *Project Documents Rules:*
 - When specific project documents are identified the first time, they are listed as a specific output. Subsequently, they are listed as “project documents updates” in the output list, and described in the section narrative.
 - When any project document is an input, the term “project documents” is listed and the specific project documents are described in the section narrative.
- ◆ *Project Management Plan Rules:*
 - For those planning processes that create a subsidiary plan, the project charter is the first input and the project management plan is the second input.
 - The process that creates a component of the project management plan lists the component specifically. Subsequently, components are listed as “project management plan updates” in the output list, and described in the section narrative.
 - When the project management plan serves as a process input, specific components of the project management plan that may be considered are described in the section narrative.

¹ Project Management Institute. 2016. *The PMI Lexicon of Project Management Terms*. Available from <http://www.pmi.org/Lexiconterms>

◆ *Sequencing Rules:*

- If the project charter is an input, it is the first input.
- When the project management plan is an input or output, the subsidiary management plans are listed in the order of the sections in the *PMBOK® Guide* where they are produced as an output, followed by baselines and then any other plans.
- Project documents are listed in alphabetical order.
- Enterprise environmental factors and organizational process assets are listed last in that order.
- When updates are an output they are listed in the following sequence:
 - Project management plan updates,
 - Project documents updates, and
 - Organizational process assets updates.

X1.4 RULES FOR HANDLING TOOLS AND TECHNIQUES

The Sixth Edition endeavored to reduce the number of tools and techniques by focusing on those that are currently used on most projects most of the time. Based on academic and market research a number of tools and techniques were eliminated. In order to reduce repetition a tool or technique is described the first time it is listed and subsequent processes using that tool or technique refer back to the earlier description.

The Sixth Edition grouped some of the commonly used tools and techniques by their intent. Not all tools and techniques fall within a group, but for those tools or techniques that are part of a group, the group is listed and then examples of tools and techniques in that group are described in the narrative. The tools and techniques groups are:

- ◆ Data gathering,
- ◆ Data analysis,
- ◆ Data representation,
- ◆ Decision-making,
- ◆ Communication skills, and
- ◆ Interpersonal and team skills.

Appendix X6 identifies all the tools and techniques in the *PMBOK® Guide* by group, where appropriate, and lists the processes where they are used.

X1.5 PROJECT MANAGEMENT PLAN

Not every component of the project management plan is created in a separate process. Such components are considered to be created in the Develop Project Management Plan process. They include the change management plan, configuration management plan, performance measurement baseline, project life cycle, development approach, and management reviews.

X1.6 SECTION 1—INTRODUCTION

The Introduction section was significantly rewritten. Introductory information about projects, programs, and portfolios that aligns with other PMI foundational standards remains. However, there is new information on project and development life cycles, project phases, and phase gates. This information provides a high-level overview on selecting development approaches from predictive, iterative, incremental and adaptive, based on the nature of the project. New information on business documents includes the business case and the benefits management plan.

X1.7 SECTION 2—THE ENVIRONMENT IN WHICH PROJECTS OPERATE

The content of Section 2 was significantly rewritten. Information on organizational process assets and enterprise environmental factors remains. However, there is new content on governance, management elements, and organizational structure types.

X1.8 SECTION 3—THE ROLE OF THE PROJECT MANAGER

This is a new section that outlines the project manager's role on the team. It includes information on the project manager's sphere of influence and competencies. PMI's Talent Triangle® is discussed with its emphasis on strategic and business management skills, technical project management skills, and leadership skills. Leadership styles and personality are also discussed as part of this section. The final part of this section focuses on the project manager as an integrator.

X1.9 AGILE

Since the Fifth Edition of the *PMBOK® Guide* there has been more adoption of agile and adaptive methodologies in the management of projects. The Sixth Edition has included a subsection called Considerations for Adaptive Environments at the beginning of Sections 4 through 13. Some agile-specific tools and techniques have been introduced into the *PMBOK® Guide*, such as sprint and iteration planning. Appendix X3 describes the use of agile, adaptive, iterative, and hybrid approaches from the perspective of the Project Management Process Groups.

X1.10 KNOWLEDGE AREA FRONT MATERIAL

Each of the Knowledge Area sections includes standardized material prior to introducing the first process. The material is presented in the following subsections:

- ◆ **Key Concepts.** Collects key concepts associated with the specific knowledge area. This information was presented in earlier editions; in this edition it is consolidated and presented for consistency between knowledge areas. These key concepts are compiled in Appendix X4.
- ◆ **Trends and Emerging Practices.** The profession of project management continues to evolve. However, the purpose of the *PMBOK® Guide* is not to lead the industry; it is to describe what is considered good practice on most projects most of the time. This subsection identifies some of the trends or emerging practices that are occurring, but that may not be practiced on most projects.
- ◆ **Tailoring Considerations.** The Sixth Edition emphasizes the importance of tailoring all aspects of the project to meet the needs of the organization, environment, stakeholders and other variables. This subsection identifies areas the project manager can consider when tailoring their project. These tailoring considerations are compiled in Appendix X5.
- ◆ **Considerations for Agile/Adaptive Environments.** This subsection identifies some of the areas where adaptive approaches may differ from predictive approaches in the particular Knowledge Area.

X1.11 KNOWLEDGE AREA AND PROCESS CHANGES

Two Knowledge Areas names were changed to more closely reflect the work that is done.

- ◆ Project Time Management was changed to Project Schedule Management to reflect that the project schedule is defined and managed during the project, whereas time is not managed.
- ◆ Both team resources and physical resources are addressed in the Sixth Edition. Thus, the Knowledge Area Project Human Resource Management was changed to Project Resource Management.

One process was removed and three new processes were added, to reflect changes in the way projects are managed in practice. One process was moved between Knowledge Areas. These changes are summarized below, and discussed in the relevant Knowledge Area section:

- ◆ Manage Project Knowledge (Section 4.4)—Added.
- ◆ Estimate Activity Resources (Section 6.4)—Moved to Project Resource Management.
- ◆ Control Resources (Section 9.6)—Added.
- ◆ Implement Risk Responses (Section 11.6)—Added.
- ◆ Close Procurements (Section 12.4)—Eliminated.

Several process names were changed to improve consistency across the processes and to improve clarity. Research indicates that project managers tend to monitor, facilitate, and manage rather than control, particularly in processes that involve interactions with people. Therefore, process names for Control Communications, Control Risks, and Control Stakeholder Engagement were changed to Monitor Communications, Monitor Risks, and Monitor Stakeholder Engagement. The list below summarizes all the process name changes:

- ◆ Perform Quality Assurance (Section 8.2)—Changed to Manage Quality.
- ◆ Plan Human Resource Management (Section 9.1)—Changed to Plan Resource Management.
- ◆ Acquire Project Team (Section 9.2)—Changed to Acquire Resources.
- ◆ Develop Project Team (Section 9.3)—Changed to Develop Team.
- ◆ Manage Project Team (Section 9.4)—Changed to Manage Team.
- ◆ Control Communications (Section 10.3)—Changed to Monitor Communications
- ◆ Control Risks (Section 11.6)—Changed to Monitor Risks.
- ◆ Plan Stakeholder Management (Section 13.2)—Changed to Plan Stakeholder Engagement.
- ◆ Control Stakeholder Engagement (Section 13.4)—Changed to Monitor Stakeholder Engagement.

X1.12 SECTION 4—PROJECT INTEGRATION MANAGEMENT CHANGES

A new process, Manage Project Knowledge, was added. This is a result of many deferred comments from the Fifth Edition indicating the need to address knowledge management in projects. A key output of this process is the lessons learned register. This register is used throughout many of the processes in the Sixth Edition. This emphasizes the need to learn continually throughout the project rather than waiting until the end to reflect.

Business documents are inputs to the Develop Project Charter and Close Project or Phase processes. The introduction of business documents underscores the importance of staying attuned to the business case and benefits management throughout the project. Administrative closure activities for procurements have been absorbed into the Close Project or Phase process.

Changes consistent with information described in Sections X1.1 through X1.11 were implemented. Table X1-1 summarizes the Section 4 processes:

Table X1-1. Section 4 Changes

Fifth Edition Processes	Sixth Edition Processes
4.1 Develop Project Charter	4.1 Develop Project Charter
4.2 Develop Project Management Plan	4.2 Develop Project Management Plan
4.3 Direct and Manage Project Work	4.3 Direct and Manage Project Work
4.4 Monitor and Control Project Work	4.4 Manage Project Knowledge
4.5 Perform Integrated Change Control	4.5 Monitor and Control Project Work
4.6 Close Project or Phase	4.6 Perform Integrated Change Control
	4.7 Close Project or Phase

X1.13 SECTION 5—PROJECT SCOPE MANAGEMENT CHANGES

The Sixth Edition team collaborated with The Standard for Business Analysis to ensure that both foundational standards were aligned, though not duplicative. No changes to process names were necessary.

Changes consistent with information described in Sections X1.1 through X1.11 were implemented.

X1.14 SECTION 6—PROJECT SCHEDULE MANAGEMENT CHANGES

Section 6 was renamed from Project Time Management to Project Schedule Management. Research indicated support for the name change as project managers do not manage time, they define and manage the project schedule. Due to the shift in focus and renaming of Project Human Resource Management to Project Resource Management, the process Estimate Activity Resources was moved from this Knowledge Area to Project Resource Management. Some agile concepts were incorporated into the Develop Schedule process. Figures and associated text were updated to clarify scheduling concepts addressed in the section.

Changes consistent with information described in Sections X1.1 through X1.11 were implemented. Table X1-2 summarizes the Section 6 processes:

Table X1-2. Section 6 Changes

Fifth Edition Processes	Sixth Edition Processes
6.1 Plan Schedule Management	6.1 Plan Schedule Management
6.2 Define Activities	6.2 Define Activities
6.3 Sequence Activities	6.3 Sequence Activities
6.4 Estimate Activity Resources	6.4 Estimate Activity Durations
6.5 Estimate Activity Durations	6.5 Develop Schedule
6.6 Develop Schedule	6.6 Control Schedule
6.7 Control Schedule	

X1.15 SECTION 7—PROJECT COST MANAGEMENT CHANGES

Changes consistent with information described in Sections X1.1 through X1.11 were implemented.

X1.16 SECTION 8—PROJECT QUALITY MANAGEMENT CHANGES

Academic and market research was conducted regarding the Perform Quality Assurance process. Research indicated that many of the quality tools and techniques that were identified previously are not widely used in today's projects. The profession focuses more on managing quality through the quality management plan. Thus, the Perform Quality Assurance process shifted focus and the name was changed to Manage Quality.

Changes consistent with information described in Sections X1.1 through X1.11 were implemented. Table X1-3 summarizes the Section 8 processes:

Table X1-3. Section 8 Changes

Fifth Edition Processes	Sixth Edition Processes
8.1 Plan Quality Management	8.1 Plan Quality Management
8.2 Perform Quality Assurance	8.2 Manage Quality
8.3 Control Quality	8.3 Control Quality

X1.17 SECTION 9—PROJECT RESOURCE MANAGEMENT CHANGES

The Sixth Edition expanded the scope of this section from its previous focus on human resources to include all resources. To distinguish between human resources and other resources, the term team resources is used to refer to human resources and the term physical resources is used to refer to other resources. The Estimate Activity Resources process was transferred into this Knowledge Area from Project Schedule Management, and a new process Control Resources was added. The word “project” was eliminated from Develop Team and Manage Team as it is inferred that the only team the project manager is concerned about developing and managing is the project team.

Changes consistent with information described in Sections X1.1 through X1.11 were implemented. Table X1-4 summarizes the Section 9 processes:

Table X1-4. Section 9 Changes

Fifth Edition Processes	Sixth Edition Processes
9.1 Plan Human Resource Management	9.1 Plan Resource Management
9.2 Acquire Project Team	9.2 Estimate Activity Resources
9.3 Develop Project Team	9.3 Acquire Resources
9.4 Manage Project Team	9.4 Develop Team
	9.5 Manage Team
	9.6 Control Resources

X1.18 SECTION 10—PROJECT COMMUNICATIONS MANAGEMENT CHANGES

A subtle but important distinction was made in this section about project communication. The term “communication” indicates the act of communicating, such as facilitating a meeting, giving information and active listening. The term “communications” indicates the artifacts of communication, such as memos, presentations, and emails. Because it is not possible to control how and when people communicate, the name of the Control Communications process has been changed to Monitor Communications.

Changes consistent with information described in Sections X1.1 through X1.11 were implemented. Table X1-5 summarizes the Section 10 processes:

Table X1-5. Section 10 Changes

Fifth Edition Processes	Sixth Edition Processes
10.1 Plan Communications Management	10.1 Plan Communications Management
10.2 Manage Communications	10.2 Manage Communications
10.3 Control Communications	10.3 Monitor Communications

X1.19 SECTION 11—PROJECT RISK MANAGEMENT CHANGES

An increased emphasis on overall project risk was integrated throughout the risk management processes. A new process, Implement Risk Responses, was added. This process is part of the Executing Process Group. The new process emphasizes the importance of not just planning risk responses, but implementing them as well. A new risk response “escalate” was introduced to indicate that if risks are identified that are outside the scope of the project objectives, they should be passed to the relevant person or part of the organization. Because risks are uncertain future events or conditions, they cannot be controlled; however, they can be monitored. Thus, the process Control Risks was renamed to Monitor Risks.

Changes consistent with information described in Sections X1.1 through X1.11 were implemented. Table X1-6 summarizes the Section 11 processes:

Table X1-6. Section 11 Changes

Fifth Edition Processes	Sixth Edition Processes
11.1 Plan Risk Management	11.1 Plan Risk Management
11.2 Identify Risks	11.2 Identify Risks
11.3 Perform Qualitative Risk Analysis	11.3 Perform Qualitative Risk Analysis
11.4 Perform Quantitative Risk Analysis	11.4 Perform Quantitative Risk Analysis
11.5 Plan Risk Responses	11.5 Plan Risk Responses
11.6 Control Risks	11.6 Implement Risk Responses
	11.7 Monitor Risks

X1.20 SECTION 12—PROJECT PROCUREMENT MANAGEMENT CHANGES

Much of the information in this Knowledge Area was updated to reflect a more global perspective. Many projects are conducted with stakeholders in various countries, or by organizations with offices in multiple countries.

Market research shows that very few project managers actually close out procurements. Someone in contracts, procurement or legal departments usually has that authority. Therefore, information from Close Procurements about evaluating all completed deliverables and comparing them to the contract was absorbed into Control Procurements. Information about administrative, communications, and records was moved to Close Project or Phase.

Changes consistent with information described in Sections X1.1 through X1.11 were implemented. Table X1-7 summarizes the Section 12 processes:

Table X1-7. Section 12 Changes

Fifth Edition Processes	Sixth Edition Processes
12.1 Plan Procurement Management	12.1 Plan Procurement Management
12.2 Conduct Procurements	12.2 Conduct Procurements
12.3 Administer Procurements	12.3 Control Procurements
12.4 Close Procurements	



X1.21 SECTION 13—PROJECT STAKEHOLDER MANAGEMENT CHANGES

In keeping with current research and practice, a shift was made to focus on stakeholder engagement rather than stakeholder management. Because project managers rarely, if ever, have the ability to control stakeholders, Control Stakeholder Engagement was renamed to Monitor Stakeholder Engagement.

Changes consistent with information described in Sections X1.1 through X1.11 were implemented. Table X1-8 summarizes the Section 13 processes:

Table X1-8. Section 13 Changes

Fifth Edition Processes	Sixth Edition Processes
13.1 Identify Stakeholders	13.1 Identify Stakeholders
13.2 Plan Stakeholder Management	13.2 Plan Stakeholder Engagement
13.3 Manage Stakeholder Engagement	13.3 Manage Stakeholder Engagement
13.4 Control Stakeholder Engagement	13.4 Monitor Stakeholder Engagement

X1.22 GLOSSARY

The glossary of the *PMBOK® Guide—Sixth Edition* was updated to clarify meaning and improve the quality and accuracy of any translations. Terms that are not used in the Sixth Edition, or are not used differently from everyday usage, were eliminated.

APPENDIX X2

CONTRIBUTORS AND REVIEWERS OF THE *PMBOK® GUIDE*—SIXTH EDITION

PMI volunteers first attempted to codify the Project Management Body of Knowledge in the *Special Report on Ethics, Standards, and Accreditation*, published in 1983. Since that time, other volunteers have come forward to update and improve that original document and contribute to this globally recognized standard for project management, PMI's *A Guide to the Project Management Body of Knowledge (PMBOK® Guide)*. This appendix lists those individuals who have contributed to the development and production of the *PMBOK® Guide* – Sixth Edition. No list can adequately portray all the contributions of those who have volunteered to develop the *PMBOK® Guide* – Sixth Edition.

The Project Management Institute is grateful to all of these individuals for their support and acknowledges their contributions to the project management profession.

X2.1 *PMBOK® GUIDE*—SIXTH EDITION CORE COMMITTEE

The following individuals served as members, were contributors of text or concepts, and served as leaders within the Project Core Committee:

Cyndi Snyder Dionisio, MBA, PMP, Chair
David A. Hillson, PhD, PMI Fellow, HonFAPM, Vice Chair (Volunteer Engagement Lead & Section 11 Lead)
Lynda Bourne, DPM, FACS (Sections 10 & 13 Lead)
Larkland A. Brown, PMP, PMI-ACP (Section 6 Lead)
Pan C.P. Kao, PhD, PMP, (Sections 7 & 12 Lead)
Mercedes Martinez Sanz, PMP (Section 4 Lead)
Alejandro Romero-Torres, PhD, PMP, (Document Quality & Management Lead & Section 5 Lead)
Guy Schleffer, PfMP, PMP, (Sections 8 & 9 Lead)
Michael J. Stratton, PhD, PMP (Section 1, 2, & 3 Lead)†
Kristin L. Vitello, Standards Project Specialist
Gwen Whitman, EMBA, PfMP (Project Communications Lead)

†Deceased. The core committee and PMI acknowledge Michael J. Stratton for his work on the *PMBOK Guide* - Sixth Edition. Mike was dedicated to the profession and this work is a testament of his contributions to the field of project management.

X2.2 SIGNIFICANT CONTRIBUTORS

In addition to the members of the Project Core Committee, the following individuals provided significant input or concepts:

Ernest Baker, PMP, PRINCE2® Practitioner
Cheryl Burcham, PMP
Guido Caciagli, B., PMP
Jimmy I. Char, PMP, SDI
Cătălin-Teodor Dogaru, PhD, MBA
Andrés Falcón, PMP
Anna Maria Felici, PMP
Eren Gokce, MBA, PMP
Pamela S. Goodhue, MBA, PMP
Franco R. Graziano, MPA, PMP
Joy Gumz, CPA, PMP
Salah M. Haswah, PMP, PgMP
Puja Kasariya, PMP
Srikanth Krishnamoorthy, PMP, PGDSA
Tom Magee, MBA, PMP
David A. Maynard, MBA, PMP
Bob Mahler, PMP, PMI-RMP
Frank R. Parth, MBA, PMP
Dattatraya Y. Pathak, PMP, PfMP
Judy Payne, PhD, MBA
Nagy Attalla Saad, PMP, ITIL
Davidov Shai
Kavita Sharma, PMP, RMP
Jurgen T. Sturany, PMP
Dirk Withake, PgMP, PMP

X2.3 PMBOK® GUIDE—SIXTH EDITION CONTENT COMMITTEE

The following individuals were contributors of text or concepts and provided recommendations on drafts of the *PMBOK® Guide—Sixth Edition*:

Vahid Azadmanesh, MBA, PMP
Brad Bigelow, PMP, MSP
Wayne R. Brantley, MEd, PMP
Marcelo A. Briola PhD, PMP
Michael C. Broadway, PMP
Mariana Nella Caffarena Bolivar
Steven Flannes
Sandra Fonseca, PhD, CISA, CRISC
Theofanis C. Giotis, PMP, PMI-ACP
Piyush Govil, BE, PMP
Rex M. Holmlin, PE, PMP
Éamonn V. Kelly, DBA, PMP
Srikanth Krishnamoorthy
Fabiano de Alcântara de Lima, PhD, PMP
Shashank Neppalli
Andrea Pantano
Kristine Persun, PMP
Piyush Prakash PMP, Prince 2
Raju N. Rao, PMP, SCPM
Krupakar Reddy, PMP, PRINCE2 Practitioner
Emadeldin Seddik, PhD, PMP
Tejas V. Sura, PMP, PfMP
Nicholas Tovar
Fede Varchavsky, MBA, PMP
Angelo Valle, PhD, CRK
Ronald H. Verheijden, PMP



X2.4 REVIEWERS

X2.4.1 SME REVIEW

In addition to the members of the Committee, the following individuals provided their review and recommendations on drafts of the standard:

David P. Bieg, PMI-PBA
James F. Carilli, PMP, PgMP
Shika Carter, PMP, PgMP
Dan Deakin, PMP, CISSP
Theofanis C. Giotis, PMP, PMI-ACP
Dave Gunner, MSc, PMP
George Jucan, PMP
Ginger Levin, PhD, PMP, PgMP
Vanina Mangano, PMP, PMI-RMP
Juan Carlos Moreno, MBA, PMP
Marvin R. Nelson, MBA, SCPM
Klaus Nielsen, MBA, PMP
Chris Richards, PMP
Ivan Rincon, MBA, PMP
Shaligram Pokharel, REng (Nepal), PhD
Paul E. Shaltry, MA, PMP
Carolina Gabriela Spindola, PMP, SSBB
Langeswaran Supramaniam, C Build E FCABE, PMP
Michael A Yinger

X2.4.2 FINAL EXPOSURE DRAFT REVIEW (STANDARD PORTION)

In addition to the members of the Committee, the following individuals provided recommendations for improving the Exposure Draft of the *PMBOK® Guide—Sixth Edition* (standard portion):

Ahmed A. Raouf Hamdy, PhD, PMP	Charalampos Apostolopoulos, PhD, PMP	Nigel Blampied, PE, PMP
Farhad Abdollahyan, PMP, OPM3 CP	Rodolfo Arguello	Wolfgang Blickle, PMP, PMI-ACP
Adil Abdulghani	Abd Razak B Ariffin, PMP	Jaqueline Boeck
Tetsuhide Abe, PMP	Deepak Arora, MBA, PMP	Dennis L. Bolles, PMP
Klaus Abert	C. H. ArunPrabu, PMP	Kiron D. Bondale, PMP, PMI-RMP
Ayodeji R. Abitogun, MBA, PMP	Zaher Asfari, MBA, PMI-ACP	Raúl Borges, PMP
Taiwo Abraham	Ayman Atallah, BE, PMP	Farid F. Bouges, PhD, PMP, PfMP
Mohammad I. Abu Irshaid, PMP, PfMP	Reza Atashfaraz, MSc, PMP	Joao Boyadjian
Manuel Acosta A.	Sharaf A. Attas, PMP, PMI-RMP	Damiano Bragantini, PMP
Phill C. Akinwale, MSc, PMP	Abdurazaq Attuwaijri	Ralf Braune
Mazen Al Bazreh	Ashraf M Awwad, MSc, PMP	Kevin Brennan
Jose Rafael Alcala Gomez, PMP	Vikram Kumar B. T.	Naga Pradeep Buddhavarapu, PMP
Ameer Ali	Nabeel Eltyeb Babiker, PMP, P30	David E. Buehler, PMP
Hammam Zayed Alkouz, PMP, PMI-RMP	Mohamed A Badie, PMP, Prince2 Practitioner	Susan M. Burk
Bill Allbee, PMP	Smitha Balakrishnan	Andrea Caccamese, PMP, Prince2 Practitioner
Charmaine Y. Allen, PMP, PBA	Saket Bansal, PMP, PMI-ACP	Roberto A. Cadena Legaspi, PMP, MCI
Kristin L. Allen, PE, PMP	Manuel F. Baquero V., MSc, PMP	Shawna D. Camp, MBA, PMP
Abdulaziz Almalki	Haytham Baraka, PMP, CCP	Iker Castillo, PMP
Ayman Alminawi, MBA, PMP	Robert Barclay	Igor Castro
Ahmad Moh. Al-Musallami, MSc, PMP	Karuna Basu	Helena Cedersjö, MSc, PMP
Imad Alsadeq, P3M3, MB	Joy Beatty, PMI-PBA, CBAP	Balasubramanian Chandrasekaran, BE, PMP
Mohammed Ahmad S. Al-Shamsi, PhD, PEng	Frances Bellows, PMP, ACP	Joo-Kwan Chang
Essam Alsultan, MBA, PMP	Peter G. Bembir, MPhil, PMP	Panos Chatzipanos, PhD, Dr Eur Ing
Haluk Altunel, PhD, PMP	Anis Ben Hassen, Msc Project/Programme/Portfolio Management, PMP	Pengzhi Chen, PMP, MSC
Priscilla S. R. Alves, PMP	Racquel Benedict	Wilson Lee Chung, PMP
Angelo Amaral	German Bernate, MPM	Xavier Clerfeuille, MSc, SSL Black Belt
Barnabas Seth Amarteifio, PMP, ITIL (Expert)	Bryan D. Berthot, MBA, PMP	Martin A. Collado, PMP, ITIL
Wilson Anandaraj, MBA, PMP	Karl F. Best, PMP, CStd	Sergio Luis Conte, PhD, PMP
Guillermo Anton	Shantanu Bhamare, PMP, LIMC	Lawrence (Larry) Cooper, PMP, PMI-ACP
John Aogon, PMP	Jasbir Singh Bhogal, PMP, ITIL-V3	Hélio R. Costa, DSc
Hamid Aougab, PMP, PMI-ACP	Michael M. Bissonette, MBA, PfMP	Scott Cunningham
	Molly Blake-Michaels, MS, PMP	

Adriano Jose da Silva Neves
Hernán D'Adamo, MPM, PMP
Michelle Daigle, PMP
Larry C Dalton, PfMP, PgMP
Farshid Damirchilo, MSc
Tran Dang
Teodor Darabaneanu, PMP, MEng
Russell W. Darnall, DM, PMP
Edson G. Freitas, PMP
Jean-Michel de Jaeger, EMBA, PMP
Maria Angela de Souza Fernandes
Allan E. Dean PMP, PgMP
G. Murat Dengiz, PMP
Valerie P. Denney, DBA, PMP
Jacqueline E. Dennis, PMP, PgMP
Konika Dey, MCA, PMP
Cyndi Snyder Dionisio, MBA, PMP
Ajay Kumar Dixit, MBA, B Tech
Roland Doerr, MSc, PMP
Rex Wotan Dominguez Chang
Jorge Duenas-Lozano
Stephen M. Duffield, MPM, CPPD
Josée Dufour, PMP
Darya Duma, PEng, PMP
Keiran J. Dunne, PhD
Awab Elameer, PMP, PMI-SP
Khaled EL-Nakib, MSc, PMP
Yasir Elsadig, PMP, PfMP
Majdi N. Elyyan, PMP, PMI-RMP
Pedro Engrácia
Mark W. Erwin, PMP, PMI-ACP
Behnam Faizabadi, PhD, PMP
Marco Falcao, PMP, PMI-RMP
Puian Masudi Far, PhD, PMP
Jamil Faraj
Saurater Faraday, PMI-RMP
Fereydoun Fardad, PMP, PRINCE2
Sergio Ferreto Gutiérrez,
MPM, MBA
David Foley, MBA

Les Foley, MPM, PMP
Gloria Folle Estrada, PMP
Frank P. Forte, PMP
Laura Franch, PMP
Nestor C. Gabarda Jr., ECE, PMP
Jaime Garcia Castro, PMP
Sam Ghavanloo, PMP
Ing Gustavo Giannattasio
MBA, PMP
Sheila Gibbs
Carl M. Gilbert, PMP PfMP
Theofanis Giotis, PhD, PMP
José Abranches Gonçalves,
MSc, PMP
Juan Carlos González,
PMP, PMI-ACP
Jean Gouix, PMP, PgMP
Therese Graff
Scott M. Graffius, PMP, CSM
Brian Grafsgaard, PMP, PgMP
Sara Grilli Colombo
Anita Griner
Maxim Grishin, PhD, PMP
Robert C Grove, MBA, PMP
David Guan, PMP
Juan E. Guarache, V, BEng, PMP
Pier Luigi Guida
Vijay Guliani, PMP, PMI-PBA
Tomasz Gutmanski
Omar Haddad, CAPM, PMP
Mustafa Hafizoglu, PMP
Yoshifumi Hamamichi
Simon Harris, PMP, CGEIT
Patti M. Harter, PMP
Sean Shraden Hasley, MSIT-PM
Ahmed Hassan
Akram Hassan, PhD, PMP
Susumu Hayakawa, PMP
Bruce A. Hayes, PMP
Guangcheng He, PMP

David G. Hendrickson, PMP
Barbara Henrich
Baruch Herrera
Sergio Herrera-Apestigue,
PMP, P30
Robert Hierholtz, PhD, MBA, PMP
Robert N. Higgins V,
PMP, ITIL Expert
David A. Hillson, PhD, PMI Fellow,
HonFAPM
Shirley Hinton, PMP
Kenji Hiraishi, MsE, PMP
Lenora Holmsten, PMP, MPM
Jenny Anne Horst-Martiz, JD, PMP
Alfred J. Howard, PMP, ITIL Expert
Cynthia L. Hoxey, PMP
Gheorghe Hriscu, PMP, CGEIT
Ananth HV PMP, CSM
Guillermo A. Ibañez, PMP, ITIL
Victor Manuel Ibanez Salazar,
PMP, MA
Waleed Idris
Shuichi Ikeda, PMP
Andrea Innocenti PMP, CGEIT
Can Izgi, PMP
Pablo Jaramillo
Tariq Javed, MS, PMP
Cari Jewell, PMP, MISST
Gabriela Jimenez P.
Icwillajoe Joe
Tony Johnson, PMP, PfMP
Michele J. Jones, PMP
Yves Jordan, PMP
Alisher Kabildjanov, PMP
SS Kanagaraj, PMP, ITIL
Naoki Kasahara, PMP
Arcady Katnikov
Suhail Khaled
Basher Khalil
Aaron Ho Khong, PMP, ITIL Expert

M. Raashid Kiani, PMP, CSM
Taeyoung Kim, PMP
Ariel S. Kirshbom, PMP, ACP
Konstantinos Kirytopoulos,
PhD, PMP
Ian Koenig PMP
Athens Koliass, MPM, PMP
Henry Kondo, PMP, PfMP
Maciej Koszykowski,
PMP, PMI-RMP
Rouzbeh Kotobzadeh,
PMP, PMI-ACP
Srikanth Krishnamoorthy,
PMP, PGDSA
Amit Kumar
Devesh Kumar
Pramit Kumar, PMP
Rakesh Kumar, MBA, PMP
Santosh Kumar
S. Y. Satish Kumar
Abhilash Kuzhikat, PMP, CISA
Thierry Labriet
G.Lakshmi Sekhar, PMP, PMI-SP
Boon Soon Lam
Vincent Hiu Sing Lam, PMP
Ruchie Lamba
Deborah Langlois MBA, PMP
Alvaro Latorre, MSc, PMP
Olivier Lazar
Chang-Hee Lee, PMP, CISA
Cheryl G. Lee, PMP, PMI-PBA
Oliver F. Lehmann, MSc, PMP
Michael J Leisegang, PMP
Craig Letavec, PgMP, PfMP
Jean-Pierre Lhomme, PMP
Junquan Liu
Shihan Liu
Tong Liu (James Liu), PhD, PMP
Anand Loganathan, MS
Anand Lokhande, PMP

Nancy Lopez
Samuel López González de Murillo,
MPM, PMP
Carlos López Javier, MBA, PMP
Zheng Lou, MBA, PMP
Sérgio Lourenço, PMP, PMI-RMP
Catia Lourenço
Hugo Kleber Magalhães Lourenço,
PMP, ACP
Amy S. Lugibihl, PMP
Sergio O. Lugo, MBA, PMP
Vijaya Prasanth M. L., PMP, MCTS
José Carlos Machicao, MSc, PMP
Frederick G. Mackaden,
CRISC, PMP
Jas Madhur
Krishan Gopal Maheshwari,
PMP, ITILv3 Expert
Konstantinos Maliakas,
MSc (PM), PMP
Rich Maltzman, PMP
Vaios Maniotis
Antonio Marino, PMP, PMI-ACP
Gaitan Marius Titi, Eng, PMP
Photoula Markou-Voskou
Lou Marks, PMP
Cristian Martín Corrales, MPM, PMP
Mike McElroy, MHA, PMP
Jon McGlothian, MBA, PMP
William T. McNamara, PMP
Rob D. Meadows, MBA, PMP
Alain Patrick Medenou,
PMP, PRINCE2 Practitioner
Lourdes Medina, PMP, PfMP
Peter Berndt de Souza Mello,
PMI-SP, PMP
Yan Bello Mendez
Ernst Menet, PMP
Sunil Meshram, PMP
Mohammed M'Hamdi, PMP

Lubomira Mihailova, MBA, PMP
Gloria J. Miller, PMP
Romeo Mitchell, MSc, BSc
Mannan Mohammed, Peng, PMP
Venkatram Vasi Mohanvasi
Ricardo Monteiro
Paula Morais
Maciej Mordaka, PMP
Rachel A. Morris, PMP
Doris Moss
Henrique Moura, PMP, PMI-RMP
Timur Mukharyamov, PhD, PMP
Antonio Muntaner, PMP
Muktesh Murthy, MBA (IS), PMP
Lemya Musa M. Idris,
PMP, PMI-PBA
Khalid M. Musleh, PMP, PMI-RMP
Syed Ahsan Mustaqeem, PE, PMP
Todd Nielsen Myers, MBA, PMP
Narayanaswamy Nagarajan, PMP
Kiran Nalam
Faig Nasibov, PMP
Asad Naveed, PMP, RMP
Serge Patrick N'Guessan,
MSIS, PMP
Praveen K. Nidumolu,
PMP, PMI-ACP
Eric Nielsen, PMP
Jeffrey S. Nielsen, PMP, PgMP
Victor Nieva Martín-Portugués, PMP
Michael C. Nollet, PMP, PMI-ACP
Takamasa Nomura
Ernesto Antonio Noya Carbajal
Mufaro M. Nyachoto,
PMI-PBA, CAPM
Conor O'Brien,
MBA (Tech Open), PMP
Peter O'Driscoll
Michael O. Ogberuhor, PMP, EVP
Bayonle Oladoja, PMP, PRINCE2

Antonio Oliva González, PMP, EMPM
Habeb Omar, PgMP, PfMP
Stefan Ondek, PMP
Marian Oprea, PMP, ITIL
Henrique Ortega-Tenorio, PMP
Venkateswar Oruganti, FIETE, PMP
Musab Abdalimageed Osman
Abubakar
Jaime Andres Alvarez Ospina,
PMP, PMI-RMP
Tabitha A. Palmer, PMP
Neeraj Pandit, PMP
Luke Panezich, PMP, PMI-ACP
Hariyo Pangarso
Laura Paton, PMP, PMI-PBA
Seenivasan Pavanagam,
PMP, PgMP
Anil Peer, PEng, PMP
Mauricio Perez Calvo,
PMP, PMI-RMP
Dana Persada Mulyoto, MBA, PMP
LEE Nan Phin, PMP, CSM
Luca Pietrandrea
Crispin (“Kik”) Piney, BSc, PgMP
Jose Angelo Pinto, PMP, OPM3 CP
Narendra Pondugula, PMP, PMI-ACP
Hin-Fei Poon
Svetlana Prahova, PMP
B. K. Subramanya Prasad, PMP, CSM
T.V. Prasanna Raaj, PMP
Suhail Qadir, PMP, BTech
Collin Quiring, PMP, OPM3
Nader K. Rad, PMP
Noalur Rahim, PMP
Prashanth Bagepalli Rajarao,
BE, PMP
S. Ramani, PgMP, PfMP
Gurdev S. Randhawa, PMP
Alakananda Rao
Vicky Restrepo, PMP

Raman Rezaei
Tashfeen Riaz, PMP, MPM
Juan Carlos Rincón Acuña,
PhD, PMP
Juan Sebastian Rivera Ortiz
Dan Roman, PMP, PMI-ACP
Rafael Fernando Ronces Rosas,
PMP, ITIL
David W. Ross, PMP, PgMP
Kaydashov Ruslan, PMP
Philip Leslie Russell, PMP
Mohamed Salah Eldien Saad, PMP
Eyad Saadeh, PfMP, PgMP
Imad Sabonji, PMP
Kumar Sadasivan, PMP
Mihail Sadeanu, PhD, PMP
Gopal Sahai, PMP, PMI-PBA
Joudi Ahmad Said, PMP, MSc
Ibrahim Saig, PhD, PMP, MRCPI
Brian Salk, PhD, PMP
Omar A. Samaniego, PMP, PMI-RMP
Abubaker Sami, PfMP, PgMP
Carlos Sánchez Golding, PMP
Yiannis Sandis, MSc, PMP
Iván S. Tejera Santana,
PMP, PMI-ACP
Murali Santhanam, PMP, BCom
Subhendu Sarangi
Saikat Sarker, PMP
Shreesh Sarvagya
Supriya Saxena
Nicole Schelter, PMP
Kathy Schwalbe, PhD, PMP
Dion Serben
Marcus Gregorio Serrano,
MBA, PMP
Isaac Sethian, MBA, PMP
Bruce G. Shapiro, PMP
Ian Sharpe, 4-DM CPPD
Cindy C Shelton, PMP, PMI-ACP

Nitin Shende, PMP, PRINCE2
Gregory P. Shetler, PhD, PgMP
Patricia C. C. Sibinelli, MEng, PMP
Alexsandro Silva
Christopher M. Simonek, PMP
Rohit Singh
Sathya Sivagurunathan
Venkatramanan S., PMP
Michelle A. Sobers, MS
Pamela L. Soderholm, PMP
Khaled Soliman
Mauro Sotille, PMP, PMI-RMP
Sriram Srinivasan, PMP, CGEIT
Pranay Srivastava, PMP, CSM
Alexander Stamenov
Jamie Stasch
John Stenbeck, PMP, PMI-ACP
Michael J. Stratton, PhD, PMP
S. Sudha, PMP
John L. Sullivan, MEd, PMP
Karen Z. Sullivan, PMP, PSM
Surichaqui Yasuji Suzuki, PMP
Mark A. Swiderski, PMP, MBA
Titus K. Syengo, PMP
Paul S. Szwed, DSc, PMP
Hadi Tahmasbi Ashtiani
Shoji Tajima, PMP, ITC
Peter Tashkoff, PMP
Ahmet Taspinar
Gokrem Tekir
Sunil Telkar PMP, PGDBL
Sal J. Thompson, MBA, PMP
Mark S. Tolbert, PMP, PMI-ACP
Mukund Toro, PMP
Stephen Tower, PMP, MBCI
John Tracy, PMP, MBA
Biagio Tramontana, Eng, PMP
Micol Trezza, MBA, PMP
Konstantin Trunin, PMP
Ahmet Tümay, PhD, PMP

M. Jeffery Tyler, PMP
Hafiz Umar, MBA, PMP
Krishnakant T. Upadhyaya, PMP
Atta Ur Rahman, MBA, PMP
Ebenezer Uy
Madhavan V.
Ali Vahedi Diz, PgMP, PfMP
Tom Van Medegael, PMP
Stephen VanArsdale
Enid T. Vargas Maldonado,
PMP, PMI-PBA
Paola D. Vargas
Allam V. V. S. Venu, PMP, PgMP
Roberto Villa, PMP
Tiziano Villa, PMP, PMI-ACP
Benjamin Villar Lurquin, Bs
Dave Violette, MPM, PMP
Vijay Srinivas Vittalam PMP, RMP
Julian Vivas
Sameh Wahba, PMP, CPMC
Prakash Waknis, PMP
Xiaojin Wang, PhD, PMP
Tsunefumi Watanabe, PMP
Barbara A. Waters, MBA, PMP
Shayla P. Watson, MA
Patrick Weaver, PMP, PMI-SP
Kevin R. Wegryn, PMP, Security+
Lars Wendestam, MSc, PMP
Jan Werewka, PMP
Carol E. P. Whitaker, MBA, PMP
Sean Whitaker, MBA, PMP
Angela Wick, PMP, PBA
Michal P. Wieteska
J. Craig Williams
Malgorzata Wolny
Sek-Kay Steve Wong, MBA, PMP
Louise M. Worsley
Yan Wu, APME, PMP
Clement C. L. Yeung, PMP

Cynthia J. Young,
PhD, PMP, LSSMBB
Gordon Young
Alan E. Yue, PMP, PMI-ACP
Hany I. Zahran
Saeed Zamani
Alessandri Zapata Rosas, PMP
Azam M. Zaqzouq, MCT, PMP
Salim Zid, MSc, PMP
Eire Emilio Zimmermann
Marcin Zmigrodzki, PhD, PgMP

X2.4.3 FINAL EXPOSURE DRAFT REVIEW (GUIDE PORTION)

In addition to the members of the Committee, the following individuals provided recommendations for improving the Exposure Draft of the *PMBOK® Guide—Sixth Edition* (guide portion):

Farhad Abdollahyan, PMP, OPM3CP	Harwinder Singh Bhatia, PMP, PMI-ACP	Ron Cwik MBA, PMP
Tetsuhide Abe, PMP	Jasbir Singh Bhogal, PMP, ITIL-V3	Yudha P. Damiat, PMP, PMI-SP
Ali Abedi, PhD, PMP	Jayaram Bhogi PMP, CSM	Farshid Damirchilo, MSc
Amir Mansour Abdollahi, MSc, PE	Michael M. Bissonette, MBA, MS	William H. Dannenmaier, PMP, MBA
Eric Aboagye	Greta Blash, PMP, PMI-ACP	Sankalpa Dash
Umesh AC	Steve Blash, PMP, PMI-ACP	Gina Davidovic PMP, PgMP
Jer Adamsson	Dennis L. Bolles, PMP	Beatriz Benezra Dehtear, MBA
Carles Adell, MPM, PMP	Rodolphe Boudet, PMP	G. Murat Dengiz, PMP
Mounir A. Ajam, RMP, GPM-bTM	Farid F. Bouges, PhD, PfMP, PMP	Stephen A. Devaux, PMP, MSPM
Uğur Aksoylu, PMP	Damiano Bragantini, PMP	Shanmugasundaram Dhandapani
Tarik Al Hraki, PMP, PMI-RMP	Ralf Braune, PhD, PMP	Sachin S. Dhaygude, PMP, PMI-ACP
Melad Al Aqra, PMP, MIET	Maria del Carmen Brown, PMP	Ivana Dilparic
Amer Albuttma, BSc, PMP	James N. Bullock, PMP, ASQ CMQ/OE	Marcelo Sans Dodson, DBA, PMP
Jose Rafael Alcalá Gomez, PMP	Andy Burns PMP, PMI-ACP	Nedal A. Dudin, PMP, PBA
Filippo Alessandro, PMP	Nicola Bussoni, PMP	Jorge A. Dueñas, PMP, AVS
Hammam Zayed Alkouz, PMP, PMI-RMP	Roberto A. Cadena Legaspi, PMP, MCI	Eunice Duran Tapia, PMP, PfMP
Eric Allen	Carla M. Champion, BEng (Hons), PMP	Wael K. Elmetwaly, PMP, PMI-ACP
Wasel A. Al-Muhammad, MBA, PMP	Shika Carter, PMP, PgMP	Talha M. El-Gazzar, PMP
Turki Mohammed Alqawsi, MITM	Luis Casacó, MA, PMP	Carol Elliott, MBA, PMP
Imad Alsadeq, MB, P3M3	Guillermo A. Cepeda L., PMP, PMI-RMP	Larry Elwood, PMP, CISSP
Haluk Altunel, PhD, PMP	Kristine Chapman	Angela England
Barnabas Seth Amarteifio, PMP, ITIL (Expert)	Panos Chatzipanos, PhD, Dr Eur Eng.	Marco Falcao, PMP, PMI-RMP
Serge Amon, MBA, PMP	Satish Chhiba	Puian Masudi Far, PhDc, PMP
Abd Razak B Ariffin, PMP	Aditya Chinni	Jared Farnum
Sridhar Arjula	Virgiliu Cimpoeru, PhDc, PMP	Jose L. Fernandez-Sanchez, PhD
Kalpesh Ashar, PMP, PMI-ACP	Jorge Omar Clemente, PMP, CPA	Eduardo S. Fiol, PMP
Vijaya C. Avula, PMP, ACP	Martin A. Collado, PMP, ITIL	Regis Fitzgibbon
Andy Bacon, PMP, CSP	Sergio Luis Conte, PhD, PMP	Garry Flemings
Andrey Badin	Franco Cosenza, PGDipBA, PMP	Carlos Augusto Freitas, CAPM, PMP
Sherif I. Bakr, PMP, MBA	Veronica Cruz	Scott J. Friedman, PMP, ACG
Karuna Basu		MAG Sanaa Fuchs
Chandra Beaveridge, BEng, PMP		Nestor C. Gabarda Jr., ECE, PMP
Jane Alam Belgaum, PMP		Robert M. Galbraith, PMP
Stefan Bertschi, PhD		Carl M. Gilbert, PMP, PfMP
		Theofanis Giotis, PhDc, PMP
		Dhananjay Gokhale

José Abranches Gonçalves,
MSc, PMP
Herbert G. Gonder, PMP
Edward Gorni, PMP, MSc
Julie Grabb PMP, B Math
Stuart Gray
Christiane Gresse von
Wangenheim, Dr. rer. nat., PMP
Grzegorz Grzesiak
Ahmed Guessous, PMP
Neeraj Gupta, PMP, CSM
Sunita Gupta
Raj Guttha PhD, PMP
Mustafa Hafizoglu, PMP
Kazuro Haga, PMP, PMI-RMP
Yoshifumi Hamamichi
Simon Harris, PMP, CGEIT
Gabrielle B. Haskins, PMP
Hossam Hassan
Madhavi Hawa, MBA
Randell R. Hayes II, PMP, MBA
Guangcheng He, PMP
Kym Henderson, RFD, MSc (Comp)
Sergio Herrera-Apestigue,
PMP, P30
Robert Hierholtz, PhD, MBA, PMP
Bob Hillier, PMP
Aaron Ho Khong, PMP, ITIL Expert
Scott C. Holbrook, PMP, CISSP
Regina Holzinger, PhD, PMP
Christina M. House, MBA, PMP
Gheorghe Hriscu, PMP, CGEIT
Terri Anne Iacobucci, SPHR, PMP
Guillermo A. Ibañez, PMP, ITIL
Can Izgi, PMP
Anand Jayaraman PMP, MCA
Anil K. Jayavarapu, PMP
Cari Jewell, PMP, MISST
Martina Jirickova
Alan John

Tony Johnson, PMP, PfMP
Michele J. Jones, PMP
Rajesh G. Kadwe, PMP
Orhan Kalayci, PMP, CBAP
Samer Faker Kamal,
PMP, LEED AP BD+C
Surendran Kamalanathan
Vaijayantee Kamat, PMP
Nils Kandelin
Carl Karshagen, PMP
Anton Kartamyshev
Scott Kashkin, MS, PMP
Katsuichi Kawamitsu, PMP, ITC
Rachel V. Keen, PMP
Suhail Khaled
Jamal Khalid
Eng. Ahmed Samir Khalil,
PMP, OPM3-CP
Basher Khalil
Ranga Raju Kidambi
Mostafa K. Kilani, BEng, PMP
Diwakar Killamsetty
Taeyoung Kim, PMP
Konstantinos Kirytopoulos,
PhD, PMP
Kashinath Kodliwadmanth
Maarten Koens, PMP
Dwaraka Ramana Kompally,
MBA, PMP
Henry Kondo, PMP, PfMP
Maciej Koszykowski,
PMP, PMI-RMP
Ahmed A F Krimly
Srikanth Krishnamoorthy,
PMP, PGDSA
Bret Kuhne
Avinash Kumar, PMP
Pramit Kumar, PMP
Thomas M. Kurihara
Andrew Lakritz

Boon Soon Lam
Luc R. Lang PMP
Jon Lazarus
Chang-Hee Lee PMP, CISA
Ivan Lee PMP, PMI-ACP
Oliver F. Lehmann, MSc, PMP
Katherine A. Leigh
Donald LePage
Peter Liakos, PMP, Cert APM
Tong Liu, PhD, PMP
Chandra Sekhar Lolla
Venkata Satya
Stefania Lombardi, PhD, PMP
Daniel D. Lopez, CSP, PMP
Zheng Lou, MBA, PMP
Sérgio Lourenço, PMP, PMI-RMP
Hugo Kleber Magalhães Lourenço,
PMP, ACP
Xiang Luo, PMP, PMI-PBA
José Carlos Machicao, PMP, MSc
Sowjanya Machiraju, MS, PMP
Robert Mahler
Mostafa M. Abbas, PMP, OCE
Konstantinos Maliakas,
MSc (PM), PMP
Rich Maltzman, PMP
Ammar Mango
Antonio Marino, PMP, PMI-ACP
Gaitan Marius Titi, Eng, PMP
Lou Marks, PMP
Rodrigo Marques da Rocha
Ronnie Maschk, PMP
Maria T Mata-Sivera, PMP
Kurisinkal Mathew
Stephen J. Matney, CEM, PMP
David A. Maynard, MBA, PMP
Pierre Mbeniyaba Mboundou
Thomas McCabe
Jon McGlothian, MBA, PMP
Alan McLoughlin, PMP, PMI-ACP

Ernst Menet, PMP
Mohammed M'Hamdi, PMP
Roberta Miglioranza, PMP, Prince2
Gloria J. Miller, PMP
Daniel Minahan, MSPM, PMP
Javier A Miranda, PMP, PMI-ACP
Saddam Mohammed Babikr
Mohammed
Venkatramvasi Mohanvasi, PMP
Maciej Mordaka, PMP
Paola Morgese, PMP
Moises Moshinsky, MSc, PMP
Henrique Moura, PMP, PMI-RMP
Nathan Mourfield
Alison K. Munro, MSc, PMP
Khalid M. Musleh, PMP, PMI-RMP
Vasudev Narayanan
Faig Nasibov, PMP
Daud Nasir, PMP, LSSBB
Nasrullah
Nghi M. Nguyen, PhD, PMP
Eric Nielsen, PMP
Yamanta Raj Niroula, PMP
Emily Nyindodo
Peter O'Driscoll
Kiyohisa Okada
Bayonle Oladoja, PMP, PRINCE2
Sofia Olguin
Edward C. Olszanowski III,
PMP, EMBA
Austen B. Omony, PhD, PMP
Stefan Ondek, PMP
Tom Oommen
H. Metin Ornek, PMP, MBA
Juan Carlos Pacheco
Durgadevi S. Padmanaban,
MBA, PMP
Ravindranath Palahalli
Boopathy Pallavapuram, PMP
Rajeev R. Pandey

Luke Panezich, PMP, PMI-ACP
Sungjoon Park, PMP
Gino Parravidino Jacobo, PMP, ITIL
Richard L. Pascoe, PMP
George Pasieka, PMP
Sneha Patel, PMP
Satyabrata Pati, PMP
Seenivasan Pavanasam PMP, PgMP
R. Anthoney Pavelich, PMP
P. B. Ramesh, PMP, ACP
Brent C. Peters, BA
Yvan Petit, PhD, PMP
Crispin ("Kik") Piney, BSc, PgMP
Jose Angelo Pinto, PMP, OPM3 CP
Napoleón Posada, MBA, PMP
B K Subramanya Prasad, PMP, CSM
Carl W. Pro, PMP, PMI-RMP
Srikanth PV
Nader K. Rad, PMP
Karen Rainford, EdD, PMP
S. Ramani, PfMP, PgMP
Niranjana Koodavalli Ramaswamy,
BE Mech, PGDM
Jesus Esteban Ramirez, BEng, eCS
Michele Ranaldo, PMP
Gurdev S. Randhawa, PMP
Sreekiran K. Ranganna, PMP, MBA
Alakananda Rao
Muhammad Sauood ur Rauf, PMP
P. Ravikumar, PMP, PMI-ACP
Michael Reed, PMP, PfMP
Messias Reis, PMP
Alexander V. Revin, PMP
Mohammadreza Rezaei
Gustavo Ribas
David B. Rich, PMP
Gregg D. Richie, PMP, MCTS
Edgar Robleto Cuadra
Bernard Roduit
David Roe, PMP

Rafael Fernando Ronces Rosas,
PMP, ITIL
Prakash Roshan
William S. Ruggles, PMP, CSSMBB
Nagy Attalla Saad, PMP, ITIL
Natesa Sabapathy, PhD, PMP
Kumar Sadasivan, PMP
Dzhamshid Safin, PhD, PMP
Edgardo S. Safranchik, PMP
Ibrahim Mohammed Ali Saig
Naoto Sakaue
Xavier Salas Ceciliano, MSc, PMP
Anderson Sales
Floriano Salvaterra, PMP, IPMA-C
Omar A. Samaniego, PMP, PMI-RMP
Abubaker Sami, PfMP, PgMP
Angela Sammon
P. Sampathkumar, MBA, PMP
Iván S. Tejera Santana,
PMP, PMI-ACP
Luciana de Jesus Santos, PMP
Aminu Sarafa, PMP, CCP
Darpan Saravia, PMP, CSM
Tamara Scatcherd
Stephen M. Schneider, PhD, PMP
Ludwig Schreier, Eur Ing, PMP
Birgitte Sharif, PMP
Sanjeev Sharma
Alexander Shavrin, PhD, PMP
Nitin Shende, PMP, PRINCE2
Luqman Shantal, PMP, TOGAF
N. K. Shrivastava, PMP, SPC4
Mohamad Sibai
Gustavo Silva
Sumit Kumar Sinha, PMP
Ronald Zack Sionakides, MBA, PMP
Klas Skogmar, EMBA, PMP
J. Greg Smith, EVP
Kenneth F. Smith, PhD, PMP
Pamela L. Soderholm, PMP

John Paul Soltesz
Sheilina Somani, RPP, PMP
Mauro Sotille, PMP, PMI-RMP
Setty Sreelatha, PMP, PMI-ACP
Shishir Srivastav, PMP, CSM
Pranay Srivastava, PMP, CSM
John Stenbeck, PMP, PMI-ACP
Jim Stewart
Yasuji Suzuki, PMP
Mark A. Swiderski, PMP, MBA
Ahmed Taha, PMP, PMI-RMP
Francis Taiwo, PMP, PMI-ACP
Yahya Tatar, PMP, MBA
Gerhard J. Tekes, PMP, PMI-RMP
Gokrem Tekir
João Paulo Tinoco
Claudia A. Tocantins, MSc, PMP
Mukund Toro, PMP
Juan Torres Vela
Stephen Tower, PMP, MBCI
Brenda Tracy
John Tracy, MBA, PMP

Konstantin Trunin, PMP
Tassos Tsochataridis, MSc, PMP
Krishnakant T. Upadhyaya, PMP
Ali Vahedi Diz, PgMP, PfMP
Jorge Valdés Garcíatorres,
PMP, SMC
Jose Felix Valdez-Torero, PMP
Tom Van Medegael, PMP
Raymond Z van Tonder,
PMP, ND Elec Eng
Ravi Vanukuru, BE, PMP
Ricardo Viana Vargas, MSc, PMP
Neelanshu Varma, PMP
Debbie Varn, PMP, SHRM-SCP
Vijay Vemana, PgMP, PMP
Nagesh V., PMP
Aloysio Vianna Jr., DEng, PMP
Roberto Villa, PMP
Jorge Villanueva, MSc (PM), PMP
Dave Violette, MPM, PMP
Yiannis Vithynos PMP, PMI-ACP
Steve Waddell, MBA, PMP

Xiaojin Wang, PhD, PMP
J. LeRoy Ward, PMP, PgMP
Toshiyuki Henry Watanabe, PE, PMP
Ashleigh Waters, PMP
Ganesh Watve, MBA, PMP
Patrick Weaver, PMP, PMI-SP
Michal P. Wieteska
Roger Wild, PMP
Rebecca A. Winston, JD
Lisa Wolf
Carlos Magno Xavier, PhD, PMP
Wenyi Xiao, PMP
Haotian Xu, CAPM
Clement C. L. Yeung, PMP
Saeed Zamani
Azam M. Zaqzouq, MCT, PMP
Omran M. Zbeida, PMP, BSP
Marcin Zmigrodzki, PMP, PgMP
Rolf Dieter Zschau, PMP
Alan Zucker, PMP, CSM

X2.5 PMI STANDARDS PROGRAM MEMBER ADVISORY GROUP (MAG)

The following individuals served as members of the PMI Standards Program Member Advisory Group during development of the *PMBOK® Guide*—Sixth Edition:



Maria Cristina Barbero, PMP, PMI-ACP
Brian Grafsgaard, PMP, PgMP
Hagit Landman, PMP, PMI-SP
Yvan Petit, PhD, PMP
Chris Stevens, PhD
Dave Violette, MPM, PMP
John Zlockie, MBA, PMP, PMI Standards Manager

X2.6 CONSENSUS BODY REVIEW

The following individuals served as members of the PMI Standards Program Consensus Body:

Nigel Blampied, PE, PMP
Dennis L. Bolles, PMP
Chris Cartwright, MPM, PMP
Sergio Coronado, PhD
Andrea Demaria, PMP
John L. Dettbarn, Jr., DSc, PE
Charles T. Follin, PMP
Laurence Goldsmith, MBA, PMP
Dana J Goulston, PMP
Brian Grafsgaard, PMP, PgMP
David Gunner, PMP
Dorothy L. Kangas, PMP
Thomas Kurihara
Hagit Landman, PMP, PMI-SP
Timothy MacFadyen
Harold “Mike” Mosley, Jr., PE, PMP
Eric S Norman, PMP, PgMP
Nanette Patton, MSBA, PMP
Yvan Petit, PhD, PMP
Crispin (“Kik”) Piney, BSc, PgMP
Michael Reed, PMP, PfMP
David W. Ross, PMP, PgMP
Paul E. Shaltry, PMP
Chris Stevens, PhD
Adam D. Sykes, MS, PMP
Matthew D. Tomlinson, PMP, PgMP
Dave Violette, MPM, PMP

X2.7 PRODUCTION STAFF

Special mention is due to the following employees of PMI:

Donn Greenberg, Manager, Publications
Roberta Storer, Product Editor
Barbara Walsh, Publications Production Supervisor

APPENDIX X3

AGILE, ITERATIVE, ADAPTIVE, AND HYBRID PROJECT ENVIRONMENTS

This appendix explores the nuances of how the Project Management Process Groups described in *The Standard for Project Management* are performed with respect to the project environment and life cycle.

Section 1.4.2.1 of the *PMBOK® Guide* states that the “project life cycle needs to be flexible enough to deal with the variety of factors included in the project.” It is the nature of projects to evolve as more detailed and specific information becomes available. This ability to evolve and adapt is more relevant in environments with a high degree of change and uncertainty or with a wide variation of stakeholder interpretation and expectations.

X3.1 THE CONTINUUM OF PROJECT LIFE CYCLES

To understand the application of the process in adaptive projects, the continuum of project life cycles should be defined. The *PMBOK® Guide* Glossary describes the project life cycle as “the series of phases that a project passes through from its start to its completion.” Within a project life cycle, there are generally one or more phases that are associated with the development of the product, service, or result. These are called a development life cycle. Development life cycles can be predictive (plan-driven), adaptive (agile), iterative, incremental, or a hybrid.

Figure X3-1 shows the various ways in which requirements and plans are handled, how risk and cost are managed, schedule considerations, and how the involvement of key stakeholders is handled depending on the type of life cycle being employed.

Predictive	Iterative	Agile
Requirements are defined up-front before development begins	Requirements can be elaborated at periodic intervals during delivery	Requirements are elaborated frequently during delivery
Deliver plans for the eventual deliverable. Then deliver only a single final product at end of project timeline	Delivery can be divided into subsets of the overall product	Delivery occurs frequently with customer-valued subsets of the overall product
Change is constrained as much as possible	Change is incorporated at periodic intervals	Change is incorporated in real-time during delivery
Key stakeholders are involved at specific milestones	Key stakeholders are regularly involved	Key stakeholders are continuously involved
Risk and cost are controlled by detailed planning of mostly knowable considerations	Risk and cost are controlled by progressively elaborating the plans with new information	Risk and cost are controlled as requirements and constraints emerge

Figure X3-1. The Continuum of Project Life Cycles

Predictive project life cycles are characterized by an emphasis on specification of requirements and detailed planning during the beginning phases of a project. Detailed plans based on known requirements and constraints may reduce risk and cost. Milestones for key stakeholder involvement are also planned. As execution of the detailed plan progresses, the monitoring and controlling processes focus on constraining changes that might impact the scope, schedule, or budget.

Highly adaptive or agile life cycles for projects are characterized by progressive elaboration of requirements based on short iterative planning and executing cycles. Risk and cost are reduced by progressive evolution of initial plans. Key stakeholders are continuously involved and provide frequent feedback which enables responding to changes more quickly and also leads to better quality.

The following considerations apply to the center of the life cycle continuum: (a) risk and cost are reduced by iterative evolution of initial plans; and (b) key stakeholders have more opportunities to be involved in incremental, iterative, and agile cycles than stakeholders at the project milestones of highly predictive life cycles.

Project life cycles in the center of the life cycle continuum tend to align more closely with the predictive side or the agile side of the continuum depending on the way requirements are specified, how risk and cost are handled, and the nature of key stakeholder involvement. Projects in this part of the continuum may utilize hybrid project methods.

It should be emphasized that development life cycles are complex and multidimensional. Often, the different phases in a given project employ different life cycles, just as distinct projects within a given program may each be executed differently.

X3.2 PROJECT PHASES

Section 1.2.4.2 of the *PMBOK® Guide* defines phases as “a collection of logically related project activities that culminates in the completion of one or more deliverables.” Processes in each of the Process Groups are repeated as necessary in each phase until the completion criteria for that phase have been satisfied.

Projects on the more adaptive side of the continuum make use of two recurring patterns of project phase relationships as described in Sections X3.2.1 and X3.2.2.

X3.2.1 SEQUENTIAL ITERATION-BASED PHASES

Adaptive projects are often decomposed into a sequence of phases called iterations. Each iteration utilizes the relevant project management processes. These iterations create a cadence of predictable, timeboxed pre-agreed, consistent duration that aids with scheduling.

Performing the process groups repeatedly incurs overhead. The overhead is considered necessary to effectively manage projects with high degrees of complexity, uncertainty, and change. The effort level for iteration-based phases is illustrated in Figure X3-2.

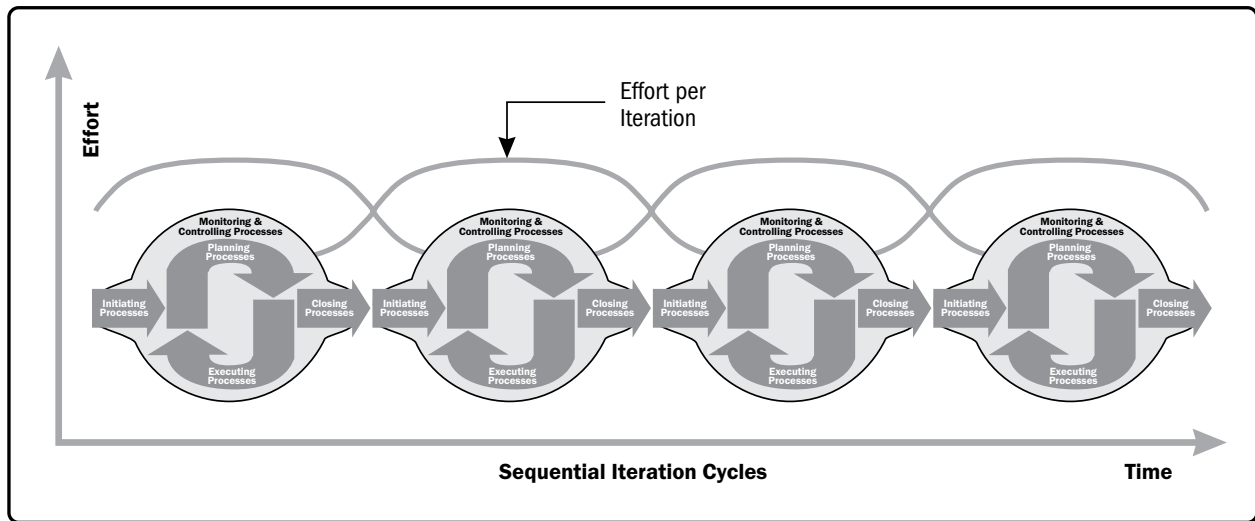

Figure X3-2. Level of Effort for Process Groups across Iteration Cycles

X3.2.2 CONTINUOUS OVERLAPPING PHASES

Projects that are highly adaptive will often perform all of the project management process groups continuously throughout the project life cycle. Inspired by techniques from lean thinking, the approach is often referred to as “continuous and adaptive planning,” which acknowledges that once work starts, the plan will change, and the plan needs to reflect this new knowledge. The intent is to aggressively refine and improve all elements of the project management plan, beyond the prescheduled checkpoints associated with iterations. The interaction of the Process Groups in this approach is illustrated in Figure X3-3.

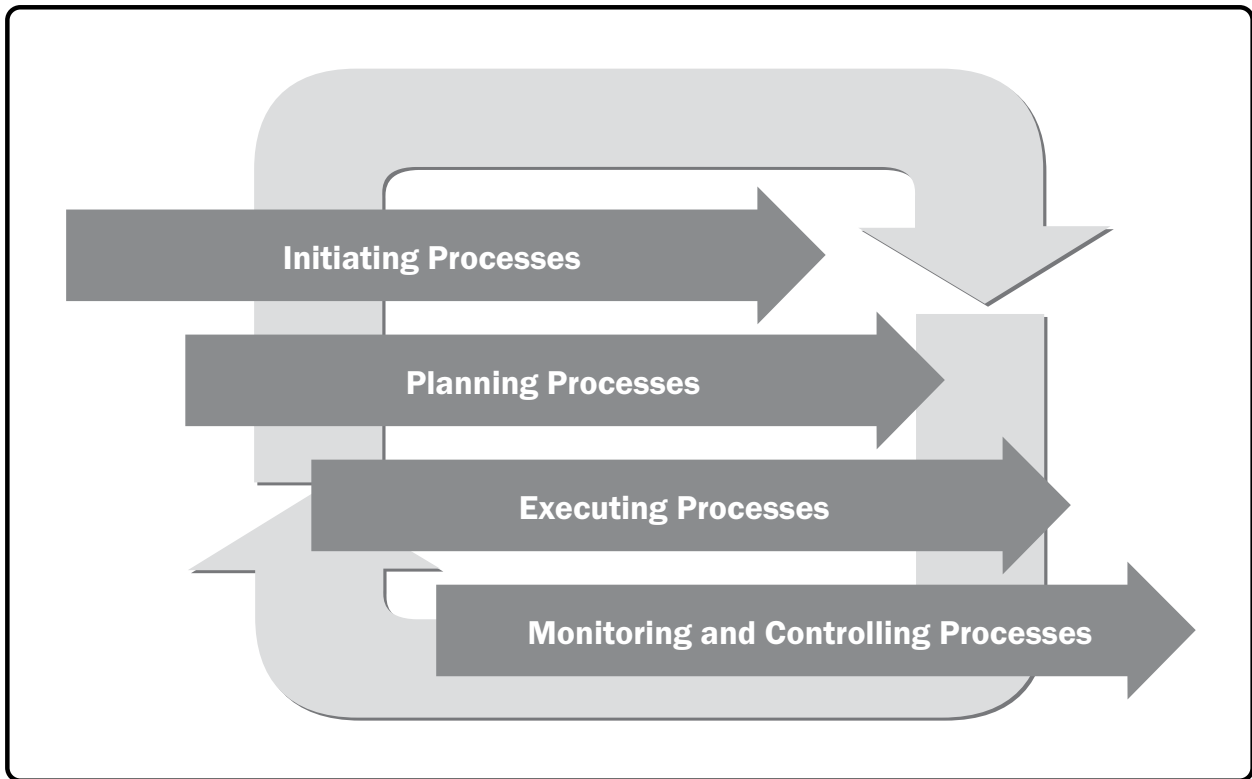

Figure X3-3. Relationship of Process Groups in Continuous Phases

These highly adaptive approaches continuously pull tasks from a prioritized list of work. This aims to minimize the overhead of managing Process Groups repeatedly, by removing the start and end of iteration activities. Continuous pull systems can be viewed as microiterations with an emphasis on maximizing the time available on execution rather than management. They do however need their own planning, tracking, and adjustment mechanisms to keep them on track and adapt to changes.

X3.3 PROCESS GROUPS IN ADAPTIVE ENVIRONMENTS

As shown in the previous section, each of the Project Management Process Groups occurs in projects across the project life cycle continuum. There are some variations in how the Process Groups interact within adaptive and highly adaptive life cycles.

X3.3.1 INITIATING PROCESS GROUP

Initiating processes are those processes performed to define a new project or a new phase of an existing project by obtaining authorization to start the project or phase. Adaptive projects revisit and revalidate the project charter on a frequent basis. As the project progresses, competing priorities and changing dynamics may cause the project constraints and success criteria to become obsolete. For this reason, the Initiating processes are performed regularly on adaptive projects in order to ensure the project is moving within constraints and toward goals that reflect the latest information.

Adaptive projects rely heavily on a knowledgeable customer or designated customer representative who can state needs and desires, and provide feedback on the emerging deliverable on a continuous, ongoing basis. Identifying this stakeholder or other stakeholders at the start of the project permits frequent interactions when performing Execution and Monitoring and Controlling processes. The associated feedback ensures that the correct project outputs are delivered. As indicated previously, an Initiating process is typically conducted on each iterative cycle of an adaptive life cycle project.

X3.3.2 PLANNING PROCESS GROUP

Planning processes are those processes required to establish the scope of the project, refine the objectives, and define the course of action required to attain the objectives that the project was undertaken to achieve.

Highly predictive project life cycles are generally characterized by few changes to project scope and high stakeholder alignment. These projects benefit from detailed up-front planning. Adaptive life cycles, on the other hand, develop a set of high-level plans for the initial requirements and progressively elaborate requirements to an appropriate level of detail for the planning cycle. Therefore, predictive and adaptive life cycles differ as to how much planning is done and when it is done.

Additionally, projects navigating high degrees of complexity and uncertainty should involve as many team members and stakeholders as possible in the planning processes. The intent is to overcome uncertainty by incorporating a wide band of input into planning.

X3.3.3 EXECUTING PROCESS GROUP

Executing processes are those processes performed to complete the work defined in the project management plan to satisfy the project requirements.

Work in agile, iterative, and adaptive project life cycles is directed and managed through iterations. Each iteration is a short, fixed time period to undertake work followed by a demonstration of functionality or design. Based on the demonstration, relevant stakeholders and the team conduct a retrospective review. The demonstration and review helps check progress against the plan and determines if any changes to the project scope, schedule, or execution processes are necessary. These sessions also help manage stakeholder engagement by showing increments of work done and discussing future work. The retrospective allows issues with the execution approach to be identified and discussed in a timely fashion along with ideas for improvements. Retrospectives are a primary tool to manage project knowledge and develop the team through discussions of what is working well and team-based problem solving.

While work is undertaken via short iterations, it is also tracked and managed against longer-term project delivery timeframes. Trends of development speed, spend, defect rates, and team capacity that are tracked at an iteration level are summed and extrapolated at a project level to track completion performance. Highly adaptive approaches aim to utilize specialized team knowledge for task completion. Rather than a project manager selecting and sequencing work, higher-level objectives are explained and the team members are empowered to self-organize specific tasks as a group to best meet those objectives. This leads to the creation of practical plans with high levels of buy-in from the team members.

Junior teams working on highly adaptive projects typically need coaching and work assignments before reaching this empowered team state. However, with progressive trials within the confines of a short iteration, teams are reviewed as part of the retrospective to determine if they acquired the required skills to perform without coaching.



X3.3.4 MONITORING AND CONTROLLING PROCESS GROUP

Monitoring and Controlling processes are those processes required to track, review, and regulate the progress and performance of the project; identify any areas in which changes to the plan are required; and initiate the corresponding changes.

Iterative, agile, and adaptive approaches track, review, and regulate progress and performance by maintaining a backlog. The backlog is prioritized by a business representative with help from the project team who estimates and provides information about technical dependencies. Work is pulled from the top of the backlog for the next iteration based on business priority and team capacity. Requests for change and defect reports are evaluated by the business representative in consultation with the team for technical input and are prioritized accordingly in the backlog of work.

This single-list-of-work-and-changes approach originated in project environments with very high rates of change that tended to overwhelm any attempts to separate change requests from originally planned work. Combining these work streams into a single backlog that can be easily resequenced provides a single place for stakeholders to manage and control project work, perform change control, and validate scope.

As prioritized tasks and changes are pulled from the backlog and completed via iterations, trends, and metrics on work performed, change effort and defect rates are calculated. By sampling progress frequently via short iterations, measures of team capacity and progress against the original scope are made by measuring the number of change impacts and defect remediation efforts. This allows estimates of cost, schedule, and scope to be made based on real progress rates and change impacts.

These metrics and projections are shared with project stakeholders via trend graphs (information radiators) to communicate progress, share issues, drive continuous improvement activities, and manage stakeholder expectations.

X3.3.5 CLOSING PROCESS GROUP

The Closing processes are the processes performed to formally complete or close a project, phase, or contract. Work on iterative, adaptive, and agile projects is prioritized to undertake the highest business value items first. So, if the Closing Process Group prematurely closes a project or phase, there is a high chance that some useful business value will already have been generated. This allows premature closure to be less of a failure due to sunk costs and more of an early benefits realization, quick win, or proof of concept for the business.



APPENDIX X4

SUMMARY OF KEY CONCEPTS FOR KNOWLEDGE AREAS

The purpose of this appendix is to provide a summary of the sections on Key Concepts for each of the Knowledge Areas in Sections 4-13. It can be used as an aid for project practitioners, a checklist of learning objectives for providers of project management training, or as a study aid by those preparing for certification.

X4.1 KEY CONCEPTS FOR PROJECT INTEGRATION MANAGEMENT

Key concepts for Project Integration Management include:

- ◆ Project Integration Management is the specific responsibility of the project manager and it cannot be delegated or transferred. The project manager is the one that combines the results from all the other Knowledge Areas to provide an overall view of the project. The project manager is ultimately responsible for the project as a whole.
- ◆ Projects and project management are integrative by nature, with most tasks involving more than one Knowledge Area.
- ◆ The relationships of processes within the Project Management Process Groups and between the Project Management Process
- ◆ Project Integration Management is about:
 - Ensuring that the due dates of project deliverables, the project life cycle, and the benefits realization plan are aligned;
 - Providing a project management plan to achieve the project objectives;
 - Ensuring the creation and the use of appropriate knowledge to and from the project;
 - Managing project performance and changes to the project activities;
 - Making integrated decisions regarding key changes impacting the project;
 - Measuring and monitoring progress and taking appropriate action;
 - Collecting, analyzing and communicating project information to relevant stakeholders;
 - Completing all the work of the project and formally closing each phase, contract, and the project as a whole; and
 - Managing phase transitions when necessary.

X4.2 KEY CONCEPTS FOR PROJECT SCOPE MANAGEMENT

Key concepts for Project Scope Management include:

- ◆ Scope can refer to product scope (the features and functions that characterize a product, service, or result), or to project scope (the work performed to deliver a product, service, or result with the specified features and functions).
- ◆ Project life cycles range along a continuum from predictive to adaptive or agile. In a life cycle that uses a predictive approach, the project deliverables are defined at the beginning of the project and any changes to the scope are progressively managed. In an adaptive or agile approach, the deliverables are developed over multiple iterations where a detailed scope is defined and approved for each iteration when it begins.
- ◆ Completion of the project scope is measured against the project management plan. Completion of the product scope is measured against the product requirements.

X4.3 KEY CONCEPTS FOR PROJECT SCHEDULE MANAGEMENT

Key concepts for Project Schedule Management include:

- ◆ Project scheduling provides a detailed plan that represents how and when the project will deliver the products, services, and results defined in the project scope.
- ◆ The project schedule is used as a tool for communication, managing stakeholder expectations, and a basis for performance reporting.
- ◆ When possible, the detailed project schedule should remain flexible throughout the project to adjust for knowledge gained, increased understanding of the risk, and value-added activities.

X4.4 KEY CONCEPTS FOR PROJECT COST MANAGEMENT

Key concepts for Project Cost Management include:

- ◆ Project Cost Management is primarily concerned with the cost of the resources needed to complete project activities, but it should also consider the effect of project decisions on the subsequent recurring cost of using, maintaining, and supporting project deliverables.
- ◆ Different stakeholders will measure project costs in different ways and at different times. Stakeholder requirements for managing costs should be considered explicitly.
- ◆ Predicting and analyzing the prospective financial performance of the project's product may be performed outside the project, or it may be part of Project Cost Management.

X4.5 KEY CONCEPTS FOR PROJECT QUALITY MANAGEMENT

Key concepts for Project Quality Management include:

- ◆ Project Quality Management addresses the management of the project and the deliverables of the project. It applies to all projects, regardless of the nature of their deliverables. Quality measures and techniques are specific to the type of deliverables being produced by the project.
- ◆ Quality and grade are different concepts. Quality is “the degree to which a set of inherent characteristics fulfills requirements” (ISO 9000).¹ Grade is a category assigned to deliverables having the same functional use but different technical characteristics. The project manager and team are responsible for managing trade-offs associated with delivering the required levels of both quality and grade.
- ◆ Prevention is preferred over inspection. It is better to design quality into deliverables, rather than to find quality issues during inspection. The cost of preventing mistakes is generally much less than the cost of correcting mistakes when they are found by inspection or during usage.
- ◆ Project managers may need to be familiar with sampling. Attribute sampling (the result either conforms or does not conform) and variable sampling (the result is rated on a continuous scale that measures the degree of conformity).
- ◆ Many projects establish tolerances and control limits for project and product measurements. Tolerances (the specified range of acceptable results) and control limits (the boundaries of common variation in a statistically stable process or process performance).
- ◆ The cost of quality (COQ) includes all costs incurred over the life of the product by investment in preventing nonconformance to requirements, appraising the product or service for conformance to requirements, and failing to meet requirements (rework). Cost of quality is often the concern of program management, portfolio management, the PMO, or operations.
- ◆ The most effective quality management is achieved when quality is incorporated into the planning and designing of the project and product, and when organizational culture is aware and committed to quality.

¹ International Standards Organization. 2015. Quality Management Systems—Fundamentals and Vocabulary. Geneva: Author.

X4.6 KEY CONCEPTS FOR PROJECT RESOURCE MANAGEMENT

Key concepts for Project Resource Management include:

- ◆ Project resources include both physical resources (equipment, materials, facilities, and infrastructure) and team resources (individuals with assigned project roles and responsibilities).
- ◆ Different skills and competences are needed to manage team resources versus physical resources.
- ◆ The project manager should be both the leader and the manager of the project team, and should invest suitable effort in acquiring, managing, motivating, and empowering team members.
- ◆ The project manager should be aware of team influences such as the team environment, geographical location of team members, communication among stakeholders, organizational change management, internal and external politics, cultural issues, and organizational uniqueness.
- ◆ The project manager is responsible for proactively developing team skills and competences while retaining and improving team satisfaction and motivation.
- ◆ Physical resource management is concentrated on allocating and utilizing the physical resources needed for successful completion of the project in an efficient and effective way. Failure to manage and control resources efficiently may reduce the chance of completing the project successfully.

X4.7 KEY CONCEPTS FOR PROJECT COMMUNICATIONS MANAGEMENT

Key concepts for Project Communications Management include:

- ◆ *Communication* is the process of exchanging information, intended or involuntary, between individuals and/or groups. *Communications* describes the means by which information can be sent or received, either through activities, such as meetings and presentations, or artifacts, such as emails, social media, project reports, or project documentation. Project Communications Management addresses both the process of communication, as well as management of communications activities and artifacts.
- ◆ Effective communication creates a bridge between diverse stakeholders whose differences will generally have an impact or influence upon the project execution or outcome, so it is vital that all communication is clear and concise.
- ◆ Communication activities include internal and external, formal and informal, written and oral.
- ◆ Communication can be directed upwards to senior management stakeholders, downwards to team members, or horizontally to peers. This will affect the format and content of the message.

- ◆ Communication takes place consciously or unconsciously through words, facial expressions, gestures and other actions. It includes developing strategies and plans for suitable communications artifacts, and the application of skills to enhance effectiveness.
- ◆ Effort is required to prevent misunderstandings and miscommunication, and the methods, messengers, and messages should be carefully selected.
- ◆ Effective communication depends on defining the purpose of communication, understanding the receiver of the communications, and monitoring effectiveness.

X4.8 KEY CONCEPTS FOR PROJECT RISK MANAGEMENT

Key concepts for Project Risk Management include:

- ◆ All projects are risky. Organizations choose to take project risk in order to create value, while balancing risk and reward.
- ◆ Project Risk Management aims to identify and manage risks that are not covered by other project management processes.
- ◆ Risk exists at two levels within every project: *Individual project risk* is an uncertain event or condition that, if it occurs, has a positive or negative effect on one or more project objectives. *Overall project risk* is the effect of uncertainty on the project as a whole, arising from all sources of uncertainty including individual risks, representing the exposure of stakeholders to the implications of variations in project outcome, both positive and negative. Project Risk Management processes address both levels of risk in projects.
- ◆ Individual project risks can have a positive or negative effect on project objectives if they occur. Overall project risk can also be positive or negative.
- ◆ Risks will continue to emerge during the lifetime of the project, so Project Risk Management processes should be conducted iteratively.
- ◆ In order to manage risk effectively on a particular project, the project team needs to know what level of risk exposure is acceptable in pursuit of project objectives. This is defined by measurable risk thresholds that reflect the risk appetite of the organization and project stakeholders.

X4.9 KEY CONCEPTS FOR PROJECT PROCUREMENT MANAGEMENT

Key concepts for project procurement management include:

- ◆ The project manager should be familiar enough with the procurement process to make intelligent decisions regarding contracts and contractual relationships.
- ◆ Procurement involves agreements that describe the relationship between a buyer and a seller. Agreements can be simple or complex, and the procurement approach should reflect the degree of complexity. An agreement can be a contract, a service-level agreement, an understanding, a memorandum of agreement, or a purchase order.
- ◆ Agreements must comply with local, national, and international laws regarding contracts.
- ◆ The project manager should ensure that all procurements meet the specific needs of the project, while working with procurement specialists to ensure organizational policies are followed.
- ◆ The legally binding nature of an agreement means it will be subjected to a more extensive approval process, often involving the legal department, to ensure that it adequately describes the products, services, or results that the seller is agreeing to provide, while being in compliance with the laws and regulations regarding procurements.
- ◆ A complex project may involve multiple contracts simultaneously or in sequence. The buyer-seller relationship may exist at many levels on any one project, and between organizations internal to and external to the acquiring organization.

X4.10 KEY CONCEPTS FOR PROJECT STAKEHOLDER MANAGEMENT

Key concepts for project stakeholder management include:

- ◆ Every project has stakeholders who are impacted by or can impact the project in a positive or negative way. Some stakeholders will have a limited ability to influence the project's work or outcomes; others will have significant influence on the project and its expected outcomes.
- ◆ The ability of the project manager and team to correctly identify and engage all of the stakeholders in an appropriate way can mean the difference between project success and failure.
- ◆ To increase the chances of success, the process of stakeholder identification and engagement should commence as soon as possible after the project charter has been approved, the project manager has been assigned, and the team begins to form.
- ◆ The key to effective stakeholder engagement is a focus on continuous communication with all stakeholders. Stakeholder satisfaction should be identified and managed as a key project objective.
- ◆ The process of identifying and engaging stakeholders for the benefit of the project is iterative, and should be reviewed and updated routinely, particularly when the project moves into a new phase, or if there are significant changes in the organization or the wider stakeholder community.

APPENDIX X5

SUMMARY OF TAILORING CONSIDERATIONS FOR KNOWLEDGE AREAS

The purpose of this appendix is to provide a summary of the Tailoring Concepts sections for each of the Knowledge Areas in Sections 4 through 13. Because each project is unique, this information can be used to aid practitioners in determining how to tailor processes, inputs, tools and techniques, and outputs for a project. This information can also help determine the degree of rigor that should be applied to the various processes in a Knowledge Area.

X5.1 PROJECT INTEGRATION MANAGEMENT

Considerations for tailoring project integration management include but are not limited to:

- ◆ **Project life cycle.** What is an appropriate project life cycle? What phases should comprise the project life cycle?
- ◆ **Development life cycle.** What development life cycle and approach is appropriate for the product, service or result? Is a predictive or adaptive approach appropriate? If adaptive, should the product be developed incrementally or iteratively? Is a hybrid approach best?
- ◆ **Management approaches.** What management processes are most effective based on the organizational culture and the complexity of the project?
- ◆ **Knowledge management.** How will knowledge be managed in the project to foster a collaborative working environment?
- ◆ **Change.** How will change be managed in the project?
- ◆ **Governance.** What control boards, committees, and other stakeholders are part of the project? What are the project status reporting requirements?
- ◆ **Lessons learned.** What information should be collected throughout and at the end of the project? How will historical information and lessons learned be made available to future projects?
- ◆ **Benefits.** When and how should benefits be reported: at the end of the project or at the end of each iteration or phase?

X5.2 PROJECT SCOPE MANAGEMENT

Considerations for tailoring project scope management include but are not limited to:

- ◆ **Knowledge and requirements management.** Does the organization have formal or informal knowledge and requirements management systems? What guidelines should the project manager establish for requirements to be reused in the future?
- ◆ **Validation and control.** Does the organization have existing formal or informal validation and control-related policies, procedures, and guidelines?
- ◆ **Use of agile approach.** Does the organization use agile approaches in managing projects? Is the development approach iterative or incremental? Is a predictive approach used? Will a hybrid approach be productive?
- ◆ **Governance.** Does the organization have formal or informal audit and governance policies, procedures, and guidelines?

X5.3 PROJECT SCHEDULE MANAGEMENT

Considerations for tailoring project schedule management include but are not limited to:

- ◆ **Life cycle approach.** What is the most appropriate life cycle approach that allows for a detailed schedule?
- ◆ **Duration and resource.** What are the factors influencing durations, such as the correlation between resource availability and productivity?
- ◆ **Project dimensions.** How will the presence of project complexity, technological uncertainty, product novelty, pace or progress tracking, (such as earned value management, percentage complete, red-yellow-green (stop light) indicators) impact the desired level of control?
- ◆ **Technology support.** Is technology used to develop, record, transmit, receive, and store project schedule model information and is it readily accessible?

X5.4 PROJECT COST MANAGEMENT

Considerations for tailoring project cost management include but are not limited to:

- ◆ **Knowledge management.** Does the organization have a formal knowledge management and financial databases repository that a project manager is required to use and is readily accessible?
- ◆ **Estimating and budgeting.** Does the organization have existing formal or informal cost estimating and budgeting-related policies, procedures, and guidelines?
- ◆ **Earned value management.** Does the organization use earned value management in managing projects?
- ◆ **Use of agile approach.** Does the organization use agile methodologies in managing projects? How does this impact cost estimating?
- ◆ **Governance.** Does the organization have formal or informal audit and governance policies, procedures, and guidelines?

X5.5 PROJECT QUALITY MANAGEMENT

Considerations for tailoring project quality management include but are not limited to:

- ◆ **Policy compliance and auditing.** What quality policies and procedures exist in the organization? What quality tools, techniques, and templates are used in the organization?
- ◆ **Standards and regulatory compliance.** Are there any specific quality standards in the industry that need to be applied? Are there any specific governmental, legal, or regulatory constraints that need to be taken into consideration?
- ◆ **Continuous improvement.** How will quality improvement be managed in the project? Is it managed at the organizational level or at the level of each project?
- ◆ **Stakeholder engagement.** Is there a collaborative environment with stakeholders and suppliers?



X5.6 PROJECT RESOURCE MANAGEMENT

Considerations for tailoring project resource management include but are not limited to:

- ◆ **Diversity.** What is the diversity background of the team?
- ◆ **Physical location.** What is the physical location of team members and physical resources?
- ◆ **Industry-specific resources.** What special resources are needed in the industry?
- ◆ **Acquisition of team members.** How will team members be acquired for the project? Are team resources full-time or part-time on the project?
- ◆ **Development and management of team.** How is team development managed for the project? Are there organizational tools to manage team development or will new ones need to be established? Will the team need special training to manage diversity?
- ◆ **Life cycle approaches.** What life cycle approach will be used on the project?

X5.7 PROJECT COMMUNICATIONS MANAGEMENT

Considerations for tailoring project communications management include but are not limited to:

- ◆ **Stakeholders.** Are the stakeholders internal or external to the organization, or both?
- ◆ **Physical location.** What is the physical location of team members? Is the team colocated? Is the team in the same geographical area? Is the team distributed across multiple time zones?
- ◆ **Communications technology.** What technology is available to develop, record, transmit, retrieve, track, and store communication artifacts? What technologies are most appropriate and cost effective for communicating to stakeholders?
- ◆ **Language.** Language is a main factor to consider in communication activities. Is one language used? Or are many languages used? Have allowances been made to adjust to the complexity of team members from diverse language groups?
- ◆ **Knowledge management.** Does the organization have a formal knowledge management repository? Is the repository used?

X5.8 PROJECT RISK MANAGEMENT

Considerations for tailoring project risk management include but are not limited to:

- ◆ **Project size.** Does the project's size in terms of budget, duration, scope, or team size require a more detailed approach to risk management? Or is it small enough to justify a simplified risk process?
- ◆ **Project complexity.** Is a robust risk approach demanded by high levels of innovation, new technology, commercial arrangements, interfaces, or external dependencies that increase project complexity? Or is the project simple enough that a reduced risk process will suffice?
- ◆ **Project importance.** How strategically important is the project? Is the level of risk increased for this project because it aims to produce breakthrough opportunities, addresses significant blocks to organizational performance, or involves major product innovation?
- ◆ **Development approach.** Is this a waterfall project where risk processes can be followed sequentially and iteratively, or does the project follow an agile approach where risk is addressed at the start of each iteration as well as during execution?

X5.9 PROJECT PROCUREMENT MANAGEMENT

Considerations for tailoring project procurement management include but are not limited to:

- ◆ **Complexity of procurement.** Is there one main procurement or are there multiple procurements at different times with different sellers that add to the complexity of the procurements?
- ◆ **Physical location.** Are the buyers and sellers in the same location or reasonably close or in different time zones, countries, or continents?
- ◆ **Governance and regulatory environment.** Are local laws and regulations regarding procurement activities integrated with the organization's procurement policies? How does this affect contract auditing requirements?
- ◆ **Availability of contractors.** Are there available contractors who are capable of performing the work?



X5.10 PROJECT STAKEHOLDER MANAGEMENT

Considerations for tailoring project stakeholder management include but are not limited to:

- ◆ **Stakeholder diversity.** How many stakeholders are there? How diverse is the culture within the stakeholder community?
- ◆ **Complexity of stakeholder relationships.** How complex are the relationships within the stakeholder community? The more networks a stakeholder or stakeholder group participates in, the more complex the networks of information and misinformation the stakeholder may receive.
- ◆ **Communication technology.** What communication technology is available? What support mechanisms are in place to ensure that best value is achieved from the technology?

APPENDIX X6

TOOLS AND TECHNIQUES

X6.1 INTRODUCTION

The *PMBOK® Guide* - Sixth Edition presents tools and techniques differently from previous editions. Where appropriate, this edition groups tools and techniques by their purpose. The group name describes the intent of what needs to be done and the tools and techniques in the group represent different methods to accomplish the intent. For example, data gathering is a group with the intent of gathering data and information. Brainstorming, interviews, and market research are among the techniques that can be used to gather data and information.

This approach reflects the emphasis in the Sixth Edition on the importance of tailoring the information presented in the *PMBOK® Guide* to the needs of the environment, situation, organization, or project.

There are 132 individual tools and techniques in the *PMBOK® Guide* – Sixth Edition. These are not the only tools and techniques that can be used to manage a project. They represent those tools and techniques that are considered to be good practice on most projects most of the time. Some are mentioned once and some appear many times in the *PMBOK® Guide*.

To assist practitioners in identifying where specific tools and techniques are used, this appendix identifies each tool and technique, the group to which it belongs (if appropriate), and the process(es) where it is listed in the *PMBOK® Guide*. The process in which a tool or technique is described in the guide is in boldface type. In other processes where the tool or technique is listed, it will reference the process in which it is described. Processes may provide additional verbiage on how a tool or technique is used in a particular process.

X6.2 TOOLS AND TECHNIQUES GROUPS

The following tools and techniques groups are used throughout the *PMBOK® Guide*:

- ◆ **Data gathering techniques.** Used to collect data and information from a variety of sources. There are nine data gathering tools and techniques.
- ◆ **Data analysis techniques.** Used to organize, assess, and evaluate data and information. There are 27 data analysis tools and techniques.
- ◆ **Data representation techniques.** Used to show graphic representations or other methods used to convey data and information. There are 15 data representation tools and techniques.
- ◆ **Decision-making techniques.** Used to select a course of action from different alternatives. There are two decision-making tools and techniques.
- ◆ **Communication skills.** Used to transfer information between stakeholders. There are two communication skills tools and techniques.
- ◆ **Interpersonal and team skills.** Used to effectively lead and interact with team members and other stakeholders. There are 17 interpersonal and team skills tools and techniques.

There are 60 ungrouped tools and techniques.

Table X6-1. Categorization and Index of Tools and Techniques

Tool and Technique	Knowledge Area ^A									
	Integration	Scope	Schedule	Cost	Quality	Resources	Communication	Risk	Procurement	Stakeholder
Data Gathering Tools and Techniques										
Benchmarking		5.2			8.1					13.2
Brainstorming	4.1 , 4.2	5.2			8.1			11.2		13.1
Check sheets					8.3					
Checklists	4.2				8.2, 8.3			11.2		
Focus groups	4.1, 4.2	5.2								
Interviews	4.1, 4.2	5.2			8.1			11.2, 11.3, 11.4, 11.5		
Market research									12.1	
Questionnaires and surveys		5.2								13.1
Statistical sampling					8.3					

Table X6-1. Categorization and Index of Tools and Techniques (cont.)

Tool and Technique	Knowledge Area ^A									
	Integration	Scope	Schedule	Cost	Quality	Resources	Communication	Risk	Procurement	Stakeholder
Data Analysis Tools and Techniques										
Alternatives analysis	4.5, 4.6	5.1, 5.4	6.1, 6.4	7.1, 7.2	8.2	9.2, 9.6		11.5		13.4
Assessment of other risk parameters								11.3		
Assumption and constraint analysis								11.2		
Cost of quality				7.2	8.1					
Cost-benefit analysis	4.5, 4.6				8.1	9.6		11.5		
Decision tree analysis								11.4		
Document analysis	4.7	5.2			8.2			11.2		13.1
Earned value analysis	4.5		6.6	7.4					12.3	
Influence diagrams								11.4		
Iteration burndown chart			6.6							
Make-or-buy analysis									12.1	
Performance reviews			6.6		8.3	9.6			12.3	
Process analysis					8.2					
Proposal evaluation									12.2	

Table X6-1. Categorization and Index of Tools and Techniques (cont.)

Tool and Technique	Knowledge Area ^A									
	Integration	Scope	Schedule	Cost	Quality	Resources	Communication	Risk	Procurement	Stakeholder
Data Analysis Tools and Techniques (cont.)										
Regression analysis		4.7								
Reserve analysis			6.4	7.2, 7.3, 7.4				11.6		
Risk data quality assessment								11.3		
Risk probability and impact assessment								11.3		
Root cause analysis	4.5				8.2, 8.3			11.2		13.2, 13.4
Sensitivity analysis								11.4		
Simulation			6.5					11.4		
Stakeholder analysis								11.1		13.1, 13.4
SWOT analysis								11.2		13.2
Technical performance analysis								11.7		
Trend analysis	4.5, 4.7	5.6	6.6	7.4		9.6			12.3	
Variance analysis	4.5, 4.7	5.6	6.6	7.4						
What-if scenario analysis			6.5, 6.6							

Table X6-1. Categorization and Index of Tools and Techniques (cont.)

Tool and Technique	Knowledge Area ^A									
	Integration	Scope	Schedule	Cost	Quality	Resources	Communication	Risk	Procurement	Stakeholder
Data Representation Tools and Techniques										
Affinity diagrams		5.2			8.2					
Cause-and-effect diagrams					8.2, 8.3					
Control charts					8.3					
Flowcharts					8.1, 8.2					
Hierarchical charts						9.1				
Histograms					8.2, 8.3					
Logical data model					8.1					
Matrix diagrams					8.1, 8.2					
Matrix-based charts						9.1				
Mind mapping		5.2			8.1					13.2
Probability and impact matrix								11.3		
Scatter diagrams					8.2, 8.3					
Stakeholder engagement assessment matrix							10.1, 10.3			13.2, 13.4
Stakeholder mapping/representation										13.1
Text-oriented formats						9.1				
Decision-Making Tools and Techniques										
Multicriteria decision analysis	4.6	5.2, 5.3			8.1, 8.2	9.3		11.5		13.4
Voting	4.5, 4.6	5.2, 5.5	6.4	7.2						13.4
Communication Skills Tools and Techniques										
Feedback							10.2			13.4
Presentations							10.2			13.4

Table X6-1. Categorization and Index of Tools and Techniques (cont.)

Tool and Technique	Knowledge Area ^A									
	Integration	Scope	Schedule	Cost	Quality	Resources	Communication	Risk	Procurement	Stakeholder
Interpersonal and Team Skills Tools and Techniques										
Active listening	4.4						10.2			13.4
Communication styles assessment							10.1			
Conflict management	4.1, 4.2					9.4, 9.5	10.2			13.3
Cultural awareness							10.1 , 10.2			13.3, 13.4
Decision making						9.5				
Emotional intelligence						9.5				
Facilitation	4.1 , 4.2, 4.4	5.2, 5.3						11.2, 11.3, 11.4, 11.5		
Influencing						9.4, 9.5 , 9.6		11.6		
Leadership	4.4					9.5				13.4
Meeting management	4.1, 4.2						10.2			
Motivation						9.4				
Negotiation						9.3, 9.4, 9.6			12.2	13.3
Networking	4.4						10.2			13.4
Nominal group technique		5.2								
Observation/ conversation		5.2					10.3			13.3
Political awareness	4.4						10.1 , 10.2			13.3, 13.4
Team building						9.4				

Table X6-1. Categorization and Index of Tools and Techniques (cont.)

Tool and Technique	Knowledge Area ^A									
	Integration	Scope	Schedule	Cost	Quality	Resources	Communication	Risk	Procurement	Stakeholder
Ungrouped Tools and Techniques										
Advertising									12.2	
Agile release planning			6.5							
Analogous estimating			6.4	7.2		9.2				
Audits					8.2			11.7	12.3	
Bidder conferences									12.2	
Bottom-up estimating			6.4	7.2		9.2				
Change control tools	4.6									
Claims administration									12.3	
Colocation						9.4				
Communication methods							10.1, 10.2			
Communication models							10.1			
Communication requirements analysis							10.1			
Communication technology						9.4	10.1, 10.2			
Context diagram		5.2								
Contingent response strategies								11.5		
Cost aggregation				7.3						
Critical path method			6.5, 6.6							

Table X6-1. Categorization and Index of Tools and Techniques (cont.)

Tool and Technique	Knowledge Area ^A									
	Integration	Scope	Schedule	Cost	Quality	Resources	Communication	Risk	Procurement	Stakeholder
Ungrouped Tools and Techniques (cont.)										
Decomposition		5.4	6.3							
Dependency determination and integration			6.3							
Design for X					8.2					
Expert judgment	4.1 , 4.2, 4.3, 4.4, 4.5, 4.6, 4.7	5.1, 5.2, 5.3, 5.4	6.1, 6.2, 6.4	7.1, 7.2, 7.3, 7.4	8.1	9.1, 9.2	10.1, 10.3	11.1, 11.2, 11.3, 11.4, 11.5, 11.6	12.1, 12.2, 12.3	13.1, 13.2, 13.3
Financing				7.3						
Funding limit reconciliation				7.3						
Ground rules										13.3
Historical information review				7.3						
Individual and team assessments						9.4				
Information management	4.4									
Inspections		5.5			8.3				12.3	13.3
Knowledge management	4.4									
Leads and lags			6.3 , 6.5, 6.6							
Meetings	4.1, 4.2, 4.3, 4.5, 4.6, 4.7	5.1	6.1, 6.2, 6.4	7.1	8.1, 8.3	9.1, 9.2, 9.4	10.1 , 10.2, 10.3	11.1, 11.2, 11.3, 11.6	12.1	13.1, 13.2, 13.3, 13.4

Table X6-1. Categorization and Index of Tools and Techniques (cont.)

Tool and Technique	Knowledge Area ^A									
	Integration	Scope	Schedule	Cost	Quality	Resources	Communication	Risk	Procurement	Stakeholder
Ungrouped Tools and Techniques (cont.)										
Organizational theory						9.1				
Parametric estimating			6.4	7.2		9.2				
Pre-assignment						9.3				
Precedence diagramming method			6.3							
Problem solving					8.2	9.6				
Product analysis		5.3								
Project management information system	4.3		6.3, 6.5, 6.6	7.2, 7.4		9.2, 9.5, 9.6	10.2, 10.3	11.6		
Project reporting					8.2					
Prompt lists								11.2		
Prototypes		5.2								
Quality improvement methods					8.2					
Recognition and rewards						9.4				
Representations of uncertainty								11.4		
Resource optimization			6.5, 6.6							
Risk categorization								11.3		
Rolling wave planning			6.2							

Table X6-1. Categorization and Index of Tools and Techniques (cont.)

Tool and Technique	Knowledge Area ^A									
	Integration	Scope	Schedule	Cost	Quality	Resources	Communication	Risk	Procurement	Stakeholder
Ungrouped Tools and Techniques (cont.)										
Schedule compression			6.5, 6.6							
Schedule network analysis			6.5							
Source selection analysis									12.1	
Strategies for opportunities								11.5		
Strategies for overall project risk								11.5		
Strategies for threats								11.5		
Test and inspection planning					8.1					
Testing/product evaluations					8.3					
Three-point estimating			6.4	7.2						
To-complete performance index				7.4						
Training							9.4			
Virtual teams							9.3, 9.4			

^A The boldface entries indicate the section numbers of the processes where a tool or technique is described.

GLOSSARY

1. INCLUSIONS AND EXCLUSIONS

This glossary includes terms that are:

- ◆ Unique or nearly unique to project management (e.g., project scope statement, work package, work breakdown structure, critical path method).
- ◆ Not unique to project management, but used differently or with a narrower meaning in project management than in general everyday usage (e.g., early start date).

This glossary generally does not include:

- ◆ Application area-specific terms.
- ◆ Terms used in project management that do not differ in any material way from everyday use (e.g., calendar day, delay).
- ◆ Compound terms whose meaning is clear from the meanings of the component parts.
- ◆ Variants when the meaning of the variant is clear from the base term.
- ◆ Terms that are used only once and are not critical to understanding the point of the sentence. This can include a list of examples that would not have each term defined in the Glossary.



2. COMMON ACRONYMS

AC	actual cost
BAC	budget at completion
CCB	change control board
COQ	cost of quality
CPAF	cost plus award fee
CPFF	cost plus fixed fee
CPI	cost performance index
CPIF	cost plus incentive fee
CPM	critical path method
CV	cost variance
EAC	estimate at completion
EF	early finish date
ES	early start date
ETC	estimate to complete
EV	earned value
EVM	earned value management
FF	finish-to-finish
FFP	firm fixed price
FPEPA	fixed price with economic price adjustment
FPIF	fixed price incentive fee
FS	finish to start
IFB	invitation for bid

LF	late finish date
LOE	level of effort
LS	late start date
OBS	organizational breakdown structure
PDM	precedence diagramming method
PMBOK	Project Management Body of Knowledge
PV	planned value
QFD	quality function deployment
RACI	responsible, accountable, consult, and inform
RAM	responsibility assignment matrix
RBS	risk breakdown structure
RFI	request for information
RFP	request for proposal
RFQ	request for quotation
SF	start-to-finish
SOW	statement of work
SPI	schedule performance index
SS	start-to-start
SV	schedule variance
SWOT	strengths, weaknesses, opportunities, and threats
T&M	time and material contract
WBS	work breakdown structure
VAC	variance at completion

3. DEFINITIONS

Many of the words defined here have broader, and in some cases different, dictionary definitions. In some cases, a single glossary term consists of multiple words (e.g., root cause analysis).

Acceptance Criteria. A set of conditions that is required to be met before deliverables are accepted.

Accepted Deliverables. Products, results, or capabilities produced by a project and validated by the project customer or sponsors as meeting their specified acceptance criteria.

Accuracy. Within the quality management system, accuracy is an assessment of correctness.

Acquire Resources. The process of obtaining team members, facilities, equipment, materials, supplies, and other resources necessary to complete project work.

Acquisition. Obtaining human and material resources necessary to perform project activities. Acquisition implies a cost of resources, and is not necessarily financial.

Activity. A distinct, scheduled portion of work performed during the course of a project.

Activity Attributes. Multiple attributes associated with each schedule activity that can be included within the activity list. Activity attributes include activity codes, predecessor activities, successor activities, logical relationships, leads and lags, resource requirements, imposed dates, constraints, and assumptions.

Activity Duration. The time in calendar units between the start and finish of a schedule activity. See also duration.

Activity Duration Estimates. The quantitative assessments of the likely number of time periods that are required to complete an activity.

Activity List. A documented tabulation of schedule activities that shows the activity description, activity identifier, and a sufficiently detailed scope of work description so project team members understand what work is to be performed.

Activity-on-Node (AON). See precedence diagramming method (PDM).

Actual Cost (AC). The realized cost incurred for the work performed on an activity during a specific time period.

Actual Duration. The time in calendar units between the actual start date of the schedule activity and either the data date of the project schedule if the schedule activity is in progress or the actual finish date if the schedule activity is complete.

Adaptive Life Cycle. A project life cycle that is iterative or incremental.

Affinity Diagrams. A technique that allows large numbers of ideas to be classified into groups for review and analysis.

Agreements. Any document or communication that defines the initial intentions of a project. This can take the form of a contract, memorandum of understanding (MOU), letters of agreement, verbal agreements, email, etc.

Alternative Analysis. A technique used to evaluate identified options in order to select the options or approaches to use to execute and perform the work of the project.

Analogous Estimating. A technique for estimating the duration or cost of an activity or a project using historical data from a similar activity or project.

Analytical Techniques. Various techniques used to evaluate, analyze, or forecast potential outcomes based on possible variations of project or environmental variables and their relationships with other variables.

Assumption. A factor in the planning process that is considered to be true, real, or certain, without proof or demonstration.

Assumption Log. A project document used to record all assumptions and constraints throughout the project life cycle.

Attribute Sampling. Method of measuring quality that consists of noting the presence (or absence) of some characteristic (attribute) in each of the units under consideration.

Authority. The right to apply project resources, expend funds, make decisions, or give approvals.

Backward Pass. A critical path method technique for calculating the late start and late finish dates by working backward through the schedule model from the project end date.

Bar Chart. A graphic display of schedule-related information. In the typical bar chart, schedule activities or work breakdown structure components are listed down the left side of the chart, dates are shown across the top, and activity durations are shown as date-placed horizontal bars. See also Gantt chart.

Baseline. The approved version of a work product that can be changed only through formal change control procedures and is used as a basis for comparison to actual results.

Basis of Estimates. Supporting documentation outlining the details used in establishing project estimates such as assumptions, constraints, level of detail, ranges, and confidence levels.

Benchmarking. Benchmarking is the comparison of actual or planned products, processes, and practices to those of comparable organizations to identify best practices, generate ideas for improvement, and provide a basis for measuring performance.

Benefits Management Plan. The documented explanation defining the processes for creating, maximizing, and sustaining the benefits provided by a project or program.

Bid Documents. All documents used to solicit information, quotations, or proposals from prospective sellers.

Bidder Conference. The meetings with prospective sellers prior to the preparation of a bid or proposal to ensure all prospective vendors have a clear and common understanding of the procurement. Also known as contractor conferences, vendor conferences, or pre-bid conferences.

Bottom-Up Estimating. A method of estimating project duration or cost by aggregating the estimates of the lower-level components of the work breakdown structure (WBS).

Budget. The approved estimate for the project or any work breakdown structure component or any schedule activity.

Budget at Completion (BAC). The sum of all budgets established for the work to be performed.

Buffer. *See reserve.*

Business Case. A documented economic feasibility study used to establish validity of the benefits of a selected component lacking sufficient definition and that is used as a basis for the authorization of further project management activities.

Business Value. The net quantifiable benefit derived from a business endeavor. The benefit may be tangible, intangible, or both.

Cause and Effect Diagram. A decomposition technique that helps trace an undesirable effect back to its root cause.

Change. A modification to any formally controlled deliverable, project management plan component, or project document.

Change Control. A process whereby modifications to documents, deliverables, or baselines associated with the project are identified, documented, approved, or rejected.

Change Control Board (CCB). A formally chartered group responsible for reviewing, evaluating, approving, delaying, or rejecting changes to the project, and for recording and communicating such decisions.

Change Control System. A set of procedures that describes how modifications to the project deliverables and documentation are managed and controlled.

Change Control Tools. Manual or automated tools to assist with change and/or configuration management. At a minimum, the tools should support the activities of the CCB.

Change Log. A comprehensive list of changes submitted during the project and their current status.

Change Management Plan. A component of the project management plan that establishes the change control board, documents the extent of its authority, and describes how the change control system will be implemented.

Change Request. A formal proposal to modify a document, deliverable, or baseline.

Charter. *See project charter.*

Checklist Analysis. A technique for systematically reviewing materials using a list for accuracy and completeness.

Checksheets. A tally sheet that can be used as a checklist when gathering data.

Claim. A request, demand, or assertion of rights by a seller against a buyer, or vice versa, for consideration, compensation, or payment under the terms of a legally binding contract, such as for a disputed change.

Claims Administration. The process of processing, adjudicating, and communicating contract claims.

Close Project or Phase. The process of finalizing all activities for the project, phase, or contract.

Closing Process Group. The process(es) performed to formally complete or close a project, phase, or contract.

Code of Accounts. A numbering system used to uniquely identify each component of the work breakdown structure (WBS).

Collect Requirements. The process of determining, documenting, and managing stakeholder needs and requirements to meet project objectives.

Colocation. An organizational placement strategy where the project team members are physically located close to one another in order to improve communication, working relationships, and productivity.

Communication Methods. A systematic procedure, technique, or process used to transfer information among project stakeholders.

Communication Models. A description, analogy, or schematic used to represent how the communication process will be performed for the project.

Communication Requirements Analysis. An analytical technique to determine the information needs of the project stakeholders through interviews, workshops, study of lessons learned from previous projects, etc.

Communications Management Plan. A component of the project, program, or portfolio management plan that describes how, when, and by whom information about the project will be administered and disseminated.

Communication Styles Assessment. A technique to identify the preferred communication method, format, and content for stakeholders for planned communication activities.

Communication Technology. Specific tools, systems, computer programs, etc., used to transfer information among project stakeholders.

Conduct Procurements. The process of obtaining seller responses, selecting a seller, and awarding a contract.

Configuration Management Plan. A component of the project management plan that describes how to identify and account for project artifacts under configuration control, and how to record and report changes to them.

Configuration Management System. A collection of procedures used to track project artifacts and monitor and control changes to these artifacts.

Conformance. Within the quality management system, conformance is a general concept of delivering results that fall within the limits that define acceptable variation for a quality requirement.

Constraint. A limiting factor that affects the execution of a project, program, portfolio, or process.

Context Diagrams. A visual depiction of the product scope showing a business system (process, equipment, computer system, etc.), and how people and other systems (actors) interact with it.

Contingency. An event or occurrence that could affect the execution of the project that may be accounted for with a reserve.

Contingency Reserve. Time or money allocated in the schedule or cost baseline for known risks with active response strategies.

Contingent Response Strategies. Responses provided which may be used in the event that a specific trigger occurs.

Contract. A contract is a mutually binding agreement that obligates the seller to provide the specified product or service or result and obligates the buyer to pay for it.

Contract Change Control System. The system used to collect, track, adjudicate, and communicate changes to a contract.

Control. Comparing actual performance with planned performance, analyzing variances, assessing trends to effect process improvements, evaluating possible alternatives, and recommending appropriate corrective action as needed.

Control Account. A management control point where scope, budget, actual cost, and schedule are integrated and compared to earned value for performance measurement.

Control Chart. A graphic display of process data over time and against established control limits, which has a centerline that assists in detecting a trend of plotted values toward either control limit.

Control Costs. The process of monitoring the status of the project to update the project costs and manage changes to the cost baseline.

Control Limits. The area composed of three standard deviations on either side of the centerline or mean of a normal distribution of data plotted on a control chart, which reflects the expected variation in the data. See also specification limits.

Control Procurements. The process of managing procurement relationships, monitoring contract performance, making changes and corrections as appropriate, and closing out contracts.

Control Quality. The process of monitoring and recording results of executing the quality management activities to assess performance and ensure the project outputs are complete, correct, and meet customer expectations.

Control Resources. The process of ensuring that the physical resources assigned and allocated to the project are available as planned, as well as monitoring the planned versus actual utilization of resources and performing corrective action as necessary.

Control Schedule. The process of monitoring the status of the project to update the project schedule and manage changes to the schedule baseline.

Control Scope. The process of monitoring the status of the project and product scope and managing changes to the scope baseline.

Corrective Action. An intentional activity that realigns the performance of the project work with the project management plan.

Cost Aggregation. Summing the lower-level cost estimates associated with the various work packages for a given level within the project's WBS or for a given cost control account.

Cost Baseline. The approved version of the time-phased project budget, excluding any management reserves, which can be changed only through formal change control procedures and is used as a basis for comparison to actual results.

Cost-Benefit Analysis. A financial analysis tool used to determine the benefits provided by a project against its costs.

Cost Management Plan. A component of a project or program management plan that describes how costs will be planned, structured, and controlled.

Cost of Quality (CoQ). All costs incurred over the life of the product by investment in preventing nonconformance to requirements, appraisal of the product or service for conformance to requirements, and failure to meet requirements.

Cost Performance Index (CPI). A measure of the cost efficiency of budgeted resources expressed as the ratio of earned value to actual cost.

Cost Plus Award Fee Contract (CPAF). A category of contract that involves payments to the seller for all legitimate actual costs incurred for completed work, plus an award fee representing seller profit.

Cost Plus Fixed Fee Contract (CPFF). A type of cost-reimbursable contract where the buyer reimburses the seller for the seller's allowable costs (allowable costs are defined by the contract) plus a fixed amount of profit (fee).

Cost Plus Incentive Fee Contract (CPIF). A type of cost-reimbursable contract where the buyer reimburses the seller for the seller's allowable costs (allowable costs are defined by the contract), and the seller earns its profit if it meets defined performance criteria.

Cost-Reimbursable Contract. A type of contract involving payment to the seller for the seller's actual costs, plus a fee typically representing the seller's profit.

Cost Variance (CV). The amount of budget deficit or surplus at a given point in time, expressed as the difference between the earned value and the actual cost.

Crashing. A technique used to shorten the schedule duration for the least incremental cost by adding resources.

Create WBS. The process of subdividing project deliverables and project work into smaller, more manageable components.

Criteria. Standards, rules, or tests on which a judgment or decision can be based or by which a product, service, result, or process can be evaluated.

Critical Path. The sequence of activities that represents the longest path through a project, which determines the shortest possible duration.

Critical Path Activity. Any activity on the critical path in a project schedule.

Critical Path Method (CPM). A method used to estimate the minimum project duration and determine the amount of schedule flexibility on the logical network paths within the schedule model.

Data. Discrete, unorganized, unprocessed measurements or raw observations.

Data Analysis Techniques. Techniques used to organize, assess, and evaluate data and information.

Data Date. A point in time when the status of the project is recorded.

Data Gathering Techniques. Techniques used to collect data and information from a variety of sources.

Data Representation Techniques. Graphic representations or other methods used to convey data and information.

Decision-Making Techniques. Techniques used to select a course of action from different alternatives.

Decision Tree Analysis. A diagramming and calculation technique for evaluating the implications of a chain of multiple options in the presence of uncertainty.

Decomposition. A technique used for dividing and subdividing the project scope and project deliverables into smaller, more manageable parts.

Defect. An imperfection or deficiency in a project component where that component does not meet its requirements or specifications and needs to be either repaired or replaced.

Defect Repair. An intentional activity to modify a nonconforming product or product component.

Define Activities. The process of identifying and documenting the specific actions to be performed to produce the project deliverables.

Define Scope. The process of developing a detailed description of the project and product.

Deliverable. Any unique and verifiable product, result, or capability to perform a service that is required to be produced to complete a process, phase, or project.

Dependency. *See logical relationship.*

Determine Budget. The process of aggregating the estimated costs of individual activities or work packages to establish an authorized cost baseline.

Development Approach. The method used to create and evolve the product, service, or result during the project life cycle, such as predictive, iterative, incremental, agile, or a hybrid method.

Develop Project Charter. The process of developing a document that formally authorizes the existence of a project and provides the project manager with the authority to apply organizational resources to project activities.

Develop Project Management Plan. The process of defining, preparing, and coordinating all plan components and consolidating them into an integrated project management plan.

Develop Schedule. The process of analyzing activity sequences, durations, resource requirements, and schedule constraints to create the project schedule model for project execution and monitoring and controlling.

Develop Team. The process of improving competences, team member interaction, and overall team environment to enhance project performance.

Diagramming Techniques. Approaches to presenting information with logical linkages that aid in understanding.

Direct and Manage Project Work. The process of leading and performing the work defined in the project management plan and implementing approved changes to achieve the project's objectives.

Discrete Effort. An activity that can be planned and measured and that yields a specific output. [Note: Discrete effort is one of three earned value management (EVM) types of activities used to measure work performance.]

Discretionary Dependency. A relationship that is established based on knowledge of best practices within a particular application area or an aspect of the project where a specific sequence is desired.

Documentation Reviews. The process of gathering a corpus of information and reviewing it to determine accuracy and completeness.

Duration. The total number of work periods required to complete an activity or work breakdown structure component, expressed in hours, days, or weeks. Contrast with effort.

Early Finish Date (EF). In the critical path method, the earliest possible point in time when the uncompleted portions of a schedule activity can finish based on the schedule network logic, the data date, and any schedule constraints.

Early Start Date (ES). In the critical path method, the earliest possible point in time when the uncompleted portions of a schedule activity can start based on the schedule network logic, the data date, and any schedule constraints.

Earned Value (EV). The measure of work performed expressed in terms of the budget authorized for that work.

Earned Value Management. A methodology that combines scope, schedule, and resource measurements to assess project performance and progress.

Effort. The number of labor units required to complete a schedule activity or work breakdown structure component, often expressed in hours, days, or weeks. *Contrast with duration.*

Emotional Intelligence. The ability to identify, assess, and manage the personal emotions of oneself and other people, as well as the collective emotions of groups of people.

Enterprise Environmental Factors. Conditions, not under the immediate control of the team, that influence, constrain, or direct the project, program, or portfolio.

Estimate. A quantitative assessment of the likely amount or outcome of a variable, such as project costs, resources, effort, or durations.

Estimate Activity Durations. The process of estimating the number of work periods needed to complete individual activities with the estimated resources.

Estimate Activity Resources. The process of estimating team resources and the type and quantities of material, equipment, and supplies necessary to perform project work.

Estimate at Completion (EAC). The expected total cost of completing all work expressed as the sum of the actual cost to date and the estimate to complete.

Estimate Costs. The process of developing an approximation of the monetary resources needed to complete project work.

Estimate to Complete (ETC). The expected cost to finish all the remaining project work.

Execute. Directing, managing, performing, and accomplishing the project work; providing the deliverables; and providing work performance information.

Executing Process Group. Those processes performed to complete the work defined in the project management plan to satisfy the project requirements.

Expert Judgment. Judgment provided based upon expertise in an application area, knowledge area, discipline, industry, etc., as appropriate for the activity being performed. Such expertise may be provided by any group or person with specialized education, knowledge, skill, experience, or training.

Explicit Knowledge. Knowledge that can be codified using symbols such as words, numbers, and pictures.

External Dependency. A relationship between project activities and non-project activities.

Fallback Plan. Fallback plans include an alternative set of actions and tasks available in the event that the primary plan needs to be abandoned because of issues, risks, or other causes.

Fast Tracking. A schedule compression technique in which activities or phases normally done in sequence are performed in parallel for at least a portion of their duration.

Fee. Represents profit as a component of compensation to a seller.

Finish Date. A point in time associated with a schedule activity's completion. Usually qualified by one of the following: actual, planned, estimated, scheduled, early, late, baseline, target, or current.

Finish-to-Finish (FF). A logical relationship in which a successor activity cannot finish until a predecessor activity has finished.

Finish-to-Start (FS). A logical relationship in which a successor activity cannot start until a predecessor activity has finished.

Firm Fixed Price Contract (FFP). A type of fixed price contract where the buyer pays the seller a set amount (as defined by the contract), regardless of the seller's costs.

Fishbone diagram. *See Cause and Effect Diagram.*

Fixed-Price Contract. An agreement that sets the fee that will be paid for a defined scope of work regardless of the cost or effort to deliver it.

Fixed Price Incentive Fee Contract (FPIF). A type of contract where the buyer pays the seller a set amount (as defined by the contract), and the seller can earn an additional amount if the seller meets defined performance criteria.

Fixed Price with Economic Price Adjustment Contract (FPEPA). A fixed-price contract, but with a special provision allowing for predefined final adjustments to the contract price due to changed conditions, such as inflation changes, or cost increases (or decreases) for specific commodities.

Float. Also called slack. *See total float and free float.*

Flowchart. The depiction in a diagram format of the inputs, process actions, and outputs of one or more processes within a system.

Focus Groups. An elicitation technique that brings together prequalified stakeholders and subject matter experts to learn about their expectations and attitudes about a proposed product, service, or result.

Forecast. An estimate or prediction of conditions and events in the project's future based on information and knowledge available at the time of the forecast.

Forward Pass. A critical path method technique for calculating the early start and early finish dates by working forward through the schedule model from the project start date or a given point in time.

Free Float. The amount of time that a schedule activity can be delayed without delaying the early start date of any successor or violating a schedule constraint.

Functional Organization. An organizational structure in which staff is grouped by areas of specialization and the project manager has limited authority to assign work and apply resources.

Funding Limit Reconciliation. The process of comparing the planned expenditure of project funds against any limits on the commitment of funds for the project to identify any variances between the funding limits and the planned expenditures.

Gantt Chart. A bar chart of schedule information where activities are listed on the vertical axis, dates are shown on the horizontal axis, and activity durations are shown as horizontal bars placed according to start and finish dates.

Grade. A category or rank used to distinguish items that have the same functional use but do not share the same requirements for quality.

Ground Rules. Expectations regarding acceptable behavior by project team members.

Histogram. A bar chart that shows the graphical representation of numerical data.

Historical Information. Documents and data on prior projects including project files, records, correspondence, closed contracts, and closed projects.

Identify Risks. The process of identifying individual risks as well as sources of overall risk and documenting their characteristics.

Identify Stakeholders. The process of identifying project stakeholders regularly and analyzing and documenting relevant information regarding their interests, involvement, interdependencies, influence, and potential impact on project success.

Implement Risk Responses. The process of implementing agreed-upon risk response plans.

Imposed Date. A fixed date imposed on a schedule activity or schedule milestone, usually in the form of a “start no earlier than” and “finish no later than” date.

Incentive Fee. A set of financial incentives related to cost, schedule, or technical performance of the seller.

Incremental Life Cycle. An adaptive project life cycle in which the deliverable is produced through a series of iterations that successively add functionality within a predetermined time frame. The deliverable contains the necessary and sufficient capability to be considered complete only after the final iteration.

Independent Estimates. A process of using a third party to obtain and analyze information to support prediction of cost, schedule, or other items.

Influence Diagram. A graphical representation of situations showing causal influences, time ordering of events, and other relationships among variables and outcomes.

Information. Organized or structured data, processed for a specific purpose to make it meaningful, valuable, and useful in specific contexts.

Information Management Systems. Facilities, processes, and procedures used to collect, store, and distribute information between producers and consumers of information in physical or electronic format.

Initiating Process Group. Those processes performed to define a new project or a new phase of an existing project by obtaining authorization to start the project or phase.

Input. Any item, whether internal or external to the project, which is required by a process before that process proceeds. May be an output from a predecessor process.

Inspection. Examination of a work product to determine whether it conforms to documented standards.

Interpersonal and Team Skills. Skills used to effectively lead and interact with team members and other stakeholders.

Interpersonal Skills. Skills used to establish and maintain relationships with other people.

Interviews. A formal or informal approach to elicit information from stakeholders by talking to them directly.

Invitation for Bid (IFB). Generally, this term is equivalent to request for proposal. However, in some application areas, it may have a narrower or more specific meaning.

Issue. A current condition or situation that may have an impact on the project objectives.

Issue Log. A project document where information about issues is recorded and monitored.

Iterative Life Cycle. A project life cycle where the project scope is generally determined early in the project life cycle, but time and cost estimates are routinely modified as the project team's understanding of the product increases. Iterations develop the product through a series of repeated cycles, while increments successively add to the functionality of the product.

Knowledge. A mixture of experience, values and beliefs, contextual information, intuition, and insight that people use to make sense of new experiences and information.

Lag. The amount of time whereby a successor activity will be delayed with respect to a predecessor activity.

Late Finish Date (LF). In the critical path method, the latest possible point in time when the uncompleted portions of a schedule activity can finish based on the schedule network logic, the project completion date, and any schedule constraints.

Late Start Date (LS). In the critical path method, the latest possible point in time when the uncompleted portions of a schedule activity can start based on the schedule network logic, the project completion date, and any schedule constraints.

Lead. The amount of time whereby a successor activity can be advanced with respect to a predecessor activity.

Lessons Learned. The knowledge gained during a project which shows how project events were addressed or should be addressed in the future for the purpose of improving future performance.

Lessons Learned Register. A project document used to record knowledge gained during a project so that it can be used in the current project and entered into the lessons learned repository.

Lessons Learned Repository. A store of historical information about lessons learned in projects.

Level of Effort (LOE). An activity that does not produce definitive end products and is measured by the passage of time.

Life Cycle. *See project life cycle.*

Log. A document used to record and describe or denote selected items identified during execution of a process or activity. Usually used with a modifier, such as issue, change, issue, or assumption.

Logical Relationship. A dependency between two activities, or between an activity and a milestone.

Make-or-Buy Analysis. The process of gathering and organizing data about product requirements and analyzing them against available alternatives including the purchase or internal manufacture of the product.

Make-or-Buy Decisions. Decisions made regarding the external purchase or internal manufacture of a product.

Manage Communications. Manage Communications is the process of ensuring timely and appropriate collection, creation, distribution, storage, retrieval, management, monitoring, and the ultimate disposition of project information.

Management Reserve. An amount of the project budget or project schedule held outside of the performance measurement baseline (PMB) for management control purposes, that is reserved for unforeseen work that is within scope of the project.

Management Skills. The ability to plan, organize, direct, and control individuals or groups of people to achieve specific goals.

Manage Project Knowledge. The process of using existing knowledge and creating new knowledge to achieve the project's objectives and contribute to organizational learning.

Manage Quality. The process of translating the quality management plan into executable quality activities that incorporate the organization's quality policies into the project.

Manage Stakeholder Engagement. The process of communicating and working with stakeholders to meet their needs and expectations, address issues, and foster appropriate stakeholder involvement.

Manage Team. The process of tracking team member performance, providing feedback, resolving issues, and managing team changes to optimize project performance.

Mandatory Dependency. A relationship that is contractually required or inherent in the nature of the work.

Master Schedule. A summary-level project schedule that identifies the major deliverables and work breakdown structure components and key schedule milestones. *See also milestone schedule.*

Matrix Diagrams. A quality management and control tool used to perform data analysis within the organizational structure created in the matrix. The matrix diagram seeks to show the strength of relationships between factors, causes, and objectives that exist between the rows and columns that form the matrix.

Matrix Organization. Any organizational structure in which the project manager shares responsibility with the functional managers for assigning priorities and for directing the work of persons assigned to the project.

Methodology. A system of practices, techniques, procedures, and rules used by those who work in a discipline.

Milestone. A significant point or event in a project, program, or portfolio.

Milestone Schedule. A type of schedule that presents milestones with planned dates. See also master schedule.

Mind-Mapping. A technique used to consolidate ideas created through individual brainstorming sessions into a single map to reflect commonality and differences in understanding and to generate new ideas.

Monitor. Collect project performance data, produce performance measures, and report and disseminate performance information.

Monitor and Control Project Work. The process of tracking, reviewing, and reporting overall progress to meet the performance objectives defined in the project management plan.

Monitor Communications. The process of ensuring that the information needs of the project and its stakeholders are met.

Monitoring and Controlling Process Group. Those processes required to track, review, and regulate the progress and performance of the project; identify any areas in which changes to the plan are required; and initiate the corresponding changes.

Monitor Risks. The process of monitoring the implementation of agreed-upon risk response plans, tracking identified risks, identifying and analyzing new risks, and evaluating risk process effectiveness throughout the project.

Monitor Stakeholder Engagement. The process of monitoring project stakeholder relationships, and tailoring strategies for engaging stakeholders through the modification of engagement strategies and plans.

Monte Carlo Simulation. An analysis technique where a computer model is iterated many times, with the input values chosen at random for each iteration driven by the input data, including probability distributions and probabilistic branches. Outputs are generated to represent the range of possible outcomes for the project.

Multicriteria Decision Analysis. This technique utilizes a decision matrix to provide a systematic analytical approach for establishing criteria, such as risk levels, uncertainty, and valuation, to evaluate and rank many ideas.

Network. *See project schedule network diagram.*

Network Logic. All activity dependencies in a project schedule network diagram.

Network Path. A sequence of activities connected by logical relationships in a project schedule network diagram.

Networking. Establishing connections and relationships with other people from the same or other organizations.

Node. A point at which dependency lines connect on a schedule network diagram.

Nominal Group Technique. A technique that enhances brainstorming with a voting process used to rank the most useful ideas for further brainstorming or for prioritization.

Objective. Something toward which work is to be directed, a strategic position to be attained, a purpose to be achieved, a result to be obtained, a product to be produced, or a service to be performed.

Opportunity. A risk that would have a positive effect on one or more project objectives.

Organizational Breakdown Structure (OBS). A hierarchical representation of the project organization, which illustrates the relationship between project activities and the organizational units that will perform those activities.

Organizational Learning. A discipline concerned with the way individuals, groups, and organizations develop knowledge.

Organizational Process Assets. Plans, processes, policies, procedures, and knowledge bases that are specific to and used by the performing organization.

Output. A product, result, or service generated by a process. May be an input to a successor process.

Overall Project Risk. The effect of uncertainty on the project as a whole, arising from all sources of uncertainty including individual risks, representing the exposure of stakeholders to the implications of variations in project outcome, both positive and negative.

Parametric Estimating. An estimating technique in which an algorithm is used to calculate cost or duration based on historical data and project parameters.

Path Convergence. A relationship in which a schedule activity has more than one predecessor.

Path Divergence. A relationship in which a schedule activity has more than one successor.

Percent Complete. An estimate expressed as a percent of the amount of work that has been completed on an activity or a work breakdown structure component.

Performance Measurement Baseline (PMB). Integrated scope, schedule, and cost baselines used for comparison to manage, measure, and control project execution.

Performance Reviews. A technique that is used to measure, compare, and analyze actual performance of work in progress on the project against the baseline.

Perform Integrated Change Control. The process of reviewing all change requests; approving changes and managing changes to deliverables, organizational process assets, project documents, and the project management plan; and communicating the decisions.

Perform Qualitative Risk Analysis. The process of prioritizing individual project risks for further analysis or action by assessing their probability of occurrence and impact as well as other characteristics.

Perform Quantitative Risk Analysis. The process of numerically analyzing the combined effect of identified individual project risks and other sources of uncertainty on overall project objectives.

Phase. *See project phase.*

Phase Gate. A review at the end of a phase in which a decision is made to continue to the next phase, to continue with modification, or to end a project or program.

Plan Communications Management. The process of developing an appropriate approach and plan for project communication activities based on the information needs of each stakeholder or group, available organizational assets, and the needs of the project.

Plan Cost Management. The process of defining how the project costs will be estimated, budgeted, managed, monitored, and controlled.

Planned Value (PV). The authorized budget assigned to scheduled work.

Planning Package. A work breakdown structure component below the control account with known work content but without detailed schedule activities. *See also control account.*

Planning Process Group. Those processes required to establish the scope of the project, refine the objectives, and define the course of action required to attain the objectives that the project was undertaken to achieve.

Plan Procurement Management. The process of documenting project procurement decisions, specifying the approach, and identifying potential sellers.

Plan Quality Management. The process of identifying quality requirements and/or standards for the project and its deliverables, and documenting how the project will demonstrate compliance with quality requirements and/or standards.

Plan Resource Management. The process of defining how to estimate, acquire, manage, and utilize physical and team resources.

Plan Risk Management. The process of defining how to conduct risk management activities for a project.

Plan Risk Responses. The process of developing options, selecting strategies, and agreeing on actions to address overall project risk exposure, as well as to treat individual project risks.

Plan Schedule Management. The process of establishing the policies, procedures, and documentation for planning, developing, managing, executing, and controlling the project schedule.

Plan Scope Management. The process of creating a scope management plan that documents how the project and product scope will be defined, validated, and controlled.

Plan Stakeholder Engagement. The process of developing approaches to involve project stakeholders, based on their needs, expectations, interests, and potential impact on the project.

Plurality. Decisions made by the largest block in a group, even if a majority is not achieved.

Policy. A structured pattern of actions adopted by an organization such that the organization's policy can be explained as a set of basic principles that govern the organization's conduct.

Portfolio. Projects, programs, subsidiary portfolios, and operations managed as a group to achieve strategic objectives.

Portfolio Management. The centralized management of one or more portfolios to achieve strategic objectives.

Practice. A specific type of professional or management activity that contributes to the execution of a process and that may employ one or more techniques and tools.

Precedence Diagramming Method (PDM). A technique used for constructing a schedule model in which activities are represented by nodes and are graphically linked by one or more logical relationships to show the sequence in which the activities are to be performed.

Precedence Relationship. A logical dependency used in the precedence diagramming method.

Predecessor Activity. An activity that logically comes before a dependent activity in a schedule.

Predictive Life Cycle. A form of project life cycle in which the project scope, time, and cost are determined in the early phases of the life cycle.

Preventive Action. An intentional activity that ensures the future performance of the project work is aligned with the project management plan.

Probability and Impact Matrix. A grid for mapping the probability of occurrence of each risk and its impact on project objectives if that risk occurs.

Procedure. An established method of accomplishing a consistent performance or result, a procedure typically can be described as the sequence of steps that will be used to execute a process.

Process. A systematic series of activities directed towards causing an end result such that one or more inputs will be acted upon to create one or more outputs.

Procurement Audits. The review of contracts and contracting processes for completeness, accuracy, and effectiveness.

Procurement Documents. The documents utilized in bid and proposal activities, which include the buyer's Invitation for bid, invitation for negotiations, request for information, request for quotation, request for proposal, and seller's responses.

Procurement Documentation. All documents used in signing, executing, and closing an agreement. Procurement documentation may include documents predating the project.

Procurement Management Plan. A component of the project or program management plan that describes how a project team will acquire goods and services from outside of the performing organization.

Procurement Statement of Work. Describes the procurement item in sufficient detail to allow prospective sellers to determine if they are capable of providing the products, services, or results.

Procurement Strategy. The approach by the buyer to determine the project delivery method and the type of legally binding agreement(s) that should be used to deliver the desired results.

Product. An artifact that is produced, is quantifiable, and can be either an end item in itself or a component item. Additional words for products are material and goods. See also deliverable.

Product Analysis. For projects that have a product as a deliverable, it is a tool to define scope that generally means asking questions about a product and forming answers to describe the use, characteristics, and other relevant aspects of what is going to be manufactured.

Product Life Cycle. The series of phases that represent the evolution of a product, from concept through delivery, growth, maturity, and to retirement.

Product Scope. The features and functions that characterize a product, service, or result.

Product Scope Description. The documented narrative description of the product scope.

Program. Related projects, subsidiary programs, and program activities that are managed in a coordinated manner to obtain benefits not available from managing them individually.

Program Management. The application of knowledge, skills, and principles to a program to achieve the program objectives and obtain benefits and control not available by managing program components individually.

Progressive Elaboration. The iterative process of increasing the level of detail in a project management plan as greater amounts of information and more accurate estimates become available.

Project. A temporary endeavor undertaken to create a unique product, service, or result.

Project Calendar. A calendar that identifies working days and shifts that are available for scheduled activities.

Project Charter. A document issued by the project initiator or sponsor that formally authorizes the existence of a project and provides the project manager with the authority to apply organizational resources to project activities.

Project Communications Management. Project Communications Management includes the processes required to ensure timely and appropriate planning, collection, creation, distribution, storage, retrieval, management, control, monitoring, and ultimate disposition of project information.

Project Cost Management. Project Cost Management includes the processes involved in planning, estimating, budgeting, financing, funding, managing, and controlling costs so the project can be completed within the approved budget.

Project Funding Requirements. Forecast project costs to be paid that are derived from the cost baseline for total or periodic requirements, including projected expenditures plus anticipated liabilities.

Project Governance. The framework, functions, and processes that guide project management activities in order to create a unique product, service, or result to meet organizational, strategic, and operational goals.

Project Initiation. Launching a process that can result in the authorization of a new project.

Project Integration Management. Project Integration Management includes the processes and activities to identify, define, combine, unify, and coordinate the various processes and project management activities within the Project Management Process Groups.

Project Life Cycle. The series of phases that a project passes through from its start to its completion.

Project Management. The application of knowledge, skills, tools, and techniques to project activities to meet the project requirements.

Project Management Body of Knowledge. A term that describes the knowledge within the profession of project management. The project management body of knowledge includes proven traditional practices that are widely applied as well as innovative practices that are emerging in the profession.

Project Management Information System. An information system consisting of the tools and techniques used to gather, integrate, and disseminate the outputs of project management processes.

Project Management Knowledge Area. An identified area of project management defined by its knowledge requirements and described in terms of its component processes, practices, inputs, outputs, tools, and techniques.

Project Management Office (PMO). A management structure that standardizes the project-related governance processes and facilitates the sharing of resources, methodologies, tools, and techniques.

Project Management Plan. The document that describes how the project will be executed, monitored and controlled, and closed.

Project Management Process Group. A logical grouping of project management inputs, tools and techniques, and outputs. The Project Management Process Groups include initiating processes, planning processes, executing processes, monitoring and controlling processes, and closing processes. Project Management Process Groups are not project phases.

Project Management System. The aggregation of the processes, tools, techniques, methodologies, resources, and procedures to manage a project.

Project Management Team. The members of the project team who are directly involved in project management activities. *See also Project Team.*

Project Manager (PM). The person assigned by the performing organization to lead the team that is responsible for achieving the project objectives.

Project Organization Chart. A document that graphically depicts the project team members and their interrelationships for a specific project.

Project Phase. A collection of logically related project activities that culminates in the completion of one or more deliverables.

Project Procurement Management. Project Procurement Management includes the processes necessary to purchase or acquire products, services, or results needed from outside the project team.

Project Quality Management. Project Quality Management includes the processes for incorporating the organization's quality policy regarding planning, managing, and controlling project and product quality requirements, in order to meet stakeholders' expectations.

Project Resource Management. Project Resource Management includes the processes to identify, acquire, and manage the resources needed for the successful completion of the project.

Project Risk Management. Project Risk Management includes the processes of conducting risk management planning, identification, analysis, response planning, response implementation, and monitoring risk on a project.

Project Schedule. An output of a schedule model that presents linked activities with planned dates, durations, milestones, and resources.

Project Schedule Management. Project Schedule Management includes the processes required to manage the timely completion of the project.

Project Schedule Network Diagram. A graphical representation of the logical relationships among the project schedule activities.

Project Scope. The work performed to deliver a product, service, or result with the specified features and functions.

Project Scope Management. Project Scope Management includes the processes required to ensure that the project includes all the work required, and only the work required, to complete the project successfully.

Project Scope Statement. The description of the project scope, major deliverables, assumptions, and constraints.

Project Stakeholder Management. Project Stakeholder Management includes the processes required to identify the people, groups, or organizations that could impact or be impacted by the project, to analyze stakeholder expectations and their impact on the project, and to develop appropriate management strategies for effectively engaging stakeholders in project decisions and execution.

Project Team. A set of individuals who support the project manager in performing the work of the project to achieve its objectives. See also Project Management Team.

Project Team Directory. A documented list of project team members, their project roles, and communication information.

Proposal Evaluation Techniques. The process of reviewing proposals provided by suppliers to support contract award decisions.

Prototypes. A method of obtaining early feedback on requirements by providing a working model of the expected product before actually building it.

Quality. The degree to which a set of inherent characteristics fulfills requirements.

Quality Audits. A quality audit is a structured, independent process to determine if project activities comply with organizational and project policies, processes, and procedures.

Quality Checklists. A structured tool used to verify that a set of required steps has been performed.

Quality Control Measurements. The documented results of control quality activities.

Quality Management Plan. A component of the project or program management plan that describes how applicable policies, procedures, and guidelines will be implemented to achieve the quality objectives.

Quality Management System. The organizational framework whose structure provides the policies, processes, procedures, and resources required to implement the quality management plan. The typical project quality management plan should be compatible to the organization's quality management system.

Quality Metrics. A description of a project or product attribute and how to measure it.

Quality Policy. A policy specific to the Project Quality Management Knowledge Area, it establishes the basic principles that should govern the organization's actions as it implements its system for quality management.

Quality Report. A project document that includes quality management issues, recommendations for corrective actions, and a summary of findings from quality control activities and may include recommendations for process, project, and product improvements.

Quality Requirement. A condition or capability that will be used to assess conformance by validating the acceptability of an attribute for the quality of a result.

Questionnaires. Written sets of questions designed to quickly accumulate information from a large number of respondents.

RACI Chart. A common type of responsibility assignment matrix that uses responsible, accountable, consult, and inform statuses to define the involvement of stakeholders in project activities.

Regression Analysis. An analytical technique where a series of input variables are examined in relation to their corresponding output results in order to develop a mathematical or statistical relationship.

Regulations. Requirements imposed by a governmental body. These requirements can establish product, process, or service characteristics, including applicable administrative provisions that have government-mandated compliance.

Request for Information (RFI). A type of procurement document whereby the buyer requests a potential seller to provide various pieces of information related to a product or service or seller capability.

Request for Proposal (RFP). A type of procurement document used to request proposals from prospective sellers of products or services. In some application areas, it may have a narrower or more specific meaning.

Request for Quotation (RFQ). A type of procurement document used to request price quotations from prospective sellers of common or standard products or services. Sometimes used in place of request for proposal and, in some application areas, it may have a narrower or more specific meaning.

Requirement. A condition or capability that is necessary to be present in a product, service, or result to satisfy a business need.

Requirements Documentation. A description of how individual requirements meet the business need for the project.

Requirements Management Plan. A component of the project or program management plan that describes how requirements will be analyzed, documented, and managed.

Requirements Traceability Matrix. A grid that links product requirements from their origin to the deliverables that satisfy them.

Reserve. A provision in the project management plan to mitigate cost and/or schedule risk. Often used with a modifier (e.g., management reserve, contingency reserve) to provide further detail on what types of risk are meant to be mitigated.

Reserve Analysis. An analytical technique to determine the essential features and relationships of components in the project management plan to establish a reserve for the schedule duration, budget, estimated cost, or funds for a project.

Residual Risk. The risk that remains after risk responses have been implemented.

Resource. A team member or any physical item needed to complete the project.

Resource Breakdown Structure. A hierarchical representation of resources by category and type.

Resource Calendar. A calendar that identifies the working days and shifts upon which each specific resource is available.

Resource Histogram. A bar chart showing the amount of time that a resource is scheduled to work over a series of time periods.

Resource Leveling. A resource optimization technique in which adjustments are made to the project schedule to optimize the allocation of resources and which may affect critical path. *See also resource optimization technique and resource smoothing.*

Resource Management Plan. A component of the project management plan that describes how project resources are acquired, allocated, monitored, and controlled.

Resource Manager. An individual with management authority over one or more resources.

Resource Optimization Technique. A technique in which activity start and finish dates are adjusted to balance demand for resources with the available supply. *See also resource leveling and resource smoothing.*

Resource Requirements. The types and quantities of resources required for each activity in a work package.

Resource Smoothing. A resource optimization technique in which free and total float are used without affecting the critical path. See also resource leveling and resource optimization technique.

Responsibility. An assignment that can be delegated within a project management plan such that the assigned resource incurs a duty to perform the requirements of the assignment.

Responsibility Assignment Matrix (RAM). A grid that shows the project resources assigned to each work package.

Result. An output from performing project management processes and activities. Results include outcomes (e.g., integrated systems, revised process, restructured organization, tests, trained personnel, etc.) and documents (e.g., policies, plans, studies, procedures, specifications, reports, etc.). See also deliverable.

Rework. Action taken to bring a defective or nonconforming component into compliance with requirements or specifications.

Risk. An uncertain event or condition that, if it occurs, has a positive or negative effect on one or more project objectives.

Risk Acceptance. A risk response strategy whereby the project team decides to acknowledge the risk and not take any action unless the risk occurs.

Risk Appetite. The degree of uncertainty an organization or individual is willing to accept in anticipation of a reward.

Risk Audit. A type of audit used to consider the effectiveness of the risk management process.

Risk Avoidance. A risk response strategy whereby the project team acts to eliminate the threat or protect the project from its impact.

Risk Breakdown Structure (RBS). A hierarchical representation of potential sources of risks.

Risk Categorization. Organization by sources of risk (e.g., using the RBS), the area of the project affected (e.g., using the WBS), or other useful category (e.g., project phase) to determine the areas of the project most exposed to the effects of uncertainty.

Risk Category. A group of potential causes of risk.

Risk Data Quality Assessment. Technique to evaluate the degree to which the data about risks is useful for risk management.

Risk Enhancement. A risk response strategy whereby the project team acts to increase the probability of occurrence or impact of an opportunity.

Risk Escalation. A risk response strategy whereby the team acknowledges that a risk is outside of its sphere of influence and shifts the ownership of the risk to a higher level of the organization where it is more effectively managed.

Risk Exploiting. A risk response strategy whereby the project team acts to ensure that an opportunity occurs.

Risk Exposure. An aggregate measure of the potential impact of all risks at any given point in time in a project, program, or portfolio.

Risk Management Plan. A component of the project, program, or portfolio management plan that describes how risk management activities will be structured and performed.

Risk Mitigation. A risk response strategy whereby the project team acts to decrease the probability of occurrence or impact of a threat.

Risk Owner. The person responsible for monitoring the risks and for selecting and implementing an appropriate risk response strategy.

Risk Register. A repository in which outputs of risk management processes are recorded.

Risk Report. A project document developed progressively throughout the Project Risk Management processes, which summarizes information on individual project risks and the level of overall project risk.

Risk Review. A meeting to examine and document the effectiveness of risk responses in dealing with overall project risk and with identified individual project risks.

Risk Sharing. A risk response strategy whereby the project team allocates ownership of an opportunity to a third party who is best able to capture the benefit of that opportunity.

Risk Threshold. The level of risk exposure above which risks are addressed and below which risks may be accepted.

Risk Transference. A risk response strategy whereby the project team shifts the impact of a threat to a third party, together with ownership of the response.

Role. A defined function to be performed by a project team member, such as testing, filing, inspecting, or coding.

Rolling Wave Planning. An iterative planning technique in which the work to be accomplished in the near term is planned in detail, while the work in the future is planned at a higher level.

Root Cause Analysis. An analytical technique used to determine the basic underlying reason that causes a variance or a defect or a risk. A root cause may underlie more than one variance or defect or risk.

Schedule. *See project schedule and schedule model.*

Schedule Baseline. The approved version of a schedule model that can be changed using formal change control procedures and is used as the basis for comparison to actual results.

Schedule Compression. A technique used to shorten the schedule duration without reducing the project scope.

Schedule Data. The collection of information for describing and controlling the schedule.

Schedule Forecasts. Estimates or predictions of conditions and events in the project's future based on information and knowledge available at the time the schedule is calculated.

Schedule Management Plan. A component of the project or program management plan that establishes the criteria and the activities for developing, monitoring, and controlling the schedule.

Schedule Model. A representation of the plan for executing the project's activities including durations, dependencies, and other planning information, used to produce a project schedule along with other scheduling artifacts.

Schedule Network Analysis. A technique to identify early and late start dates, as well as early and late finish dates, for the uncompleted portions of project activities.

Schedule Performance Index (SPI). A measure of schedule efficiency expressed as the ratio of earned value to planned value.

Schedule Variance (SV). A measure of schedule performance expressed as the difference between the earned value and the planned value.

Scheduling Tool. A tool that provides schedule component names, definitions, structural relationships, and formats that support the application of a scheduling method.

Scope. The sum of the products, services, and results to be provided as a project. See also project scope and product scope.

Scope Baseline. The approved version of a scope statement, work breakdown structure (WBS), and its associated WBS dictionary, that can be changed using formal change control procedures and is used as a basis for comparison to actual results.

Scope Creep. The uncontrolled expansion to product or project scope without adjustments to time, cost, and resources.

Scope Management Plan. A component of the project or program management plan that describes how the scope will be defined, developed, monitored, controlled, and validated.

Secondary Risk. A risk that arises as a direct result of implementing a risk response.

Self-Organizing Teams. A team formation where the team functions with an absence of centralized control.

Seller. A provider or supplier of products, services, or results to an organization.

Seller Proposals. Formal responses from sellers to a request for proposal or other procurement document specifying the price, commercial terms of sale, and technical specifications or capabilities the seller will do for the requesting organization that, if accepted, would bind the seller to perform the resulting agreement.

Sensitivity Analysis. An analysis technique to determine which individual project risks or other sources of uncertainty have the most potential impact on project outcomes, by correlating variations in project outcomes with variations in elements of a quantitative risk analysis model.

Sequence Activities. The process of identifying and documenting relationships among the project activities.

Service Level Agreement (SLA). A contract between a service provider (either internal or external) and the end user that defines the level of service expected from the service provider.

Simulation. An analytical technique that models the combined effect of uncertainties to evaluate their potential impact on objectives.

Source Selection Criteria. A set of attributes desired by the buyer which a seller is required to meet or exceed to be selected for a contract.

Specification. A precise statement of the needs to be satisfied and the essential characteristics that are required.

Specification Limits. The area, on either side of the centerline, or mean, of data plotted on a control chart that meets the customer's requirements for a product or service. This area may be greater than or less than the area defined by the control limits. See also control limits.

Sponsor. A person or group who provides resources and support for the project, program, or portfolio and is accountable for enabling success.

Sponsoring Organization. The entity responsible for providing the project's sponsor and a conduit for project funding or other project resources.

Stakeholder. An individual, group, or organization that may affect, be affected by, or perceive itself to be affected by a decision, activity, or outcome of a project, program, or portfolio.

Stakeholder Analysis. A technique of systematically gathering and analyzing quantitative and qualitative information to determine whose interests should be taken into account throughout the project.

Stakeholder Engagement Assessment Matrix. A matrix that compares current and desired stakeholder engagement levels.

Stakeholder Engagement Plan. A component of the project management plan that identifies the strategies and actions required to promote productive involvement of stakeholders in project or program decision making and execution.

Stakeholder Register. A project document including the identification, assessment, and classification of project stakeholders.

Standard. A document established by an authority, custom, or general consent as a model or example.

Start Date. A point in time associated with a schedule activity's start, usually qualified by one of the following: actual, planned, estimated, scheduled, early, late, target, baseline, or current.

Start-to-Finish (SF). A logical relationship in which a successor activity cannot finish until a predecessor activity has started.

Start-to-Start (SS). A logical relationship in which a successor activity cannot start until a predecessor activity has started.

Statement of Work (SOW). A narrative description of products, services, or results to be delivered by the project.

Statistical Sampling. Choosing part of a population of interest for inspection.

Successor Activity. A dependent activity that logically comes after another activity in a schedule.

Summary Activity. A group of related schedule activities aggregated and displayed as a single activity.

SWOT Analysis. Analysis of strengths, weaknesses, opportunities, and threats of an organization, project, or option.

Tacit Knowledge. Personal knowledge that can be difficult to articulate and share such as beliefs, experience, and insights.

Tailoring. Determining the appropriate combination of processes, inputs, tools, techniques, outputs, and life cycle phases to manage a project.

Team Charter. A document that records the team values, agreements, and operating guidelines, as well as establishing clear expectations regarding acceptable behavior by project team members.

Team Management Plan. A component of the resource management plan that describes when and how team members will be acquired and how long they will be needed.

Technique. A defined systematic procedure employed by a human resource to perform an activity to produce a product or result or deliver a service, and that may employ one or more tools.

Templates. A partially complete document in a predefined format that provides a defined structure for collecting, organizing, and presenting information and data.

Test and Evaluation Documents. Project documents that describe the activities used to determine if the product meets the quality objectives stated in the quality management plan.

Threat. A risk that would have a negative effect on one or more project objectives.

Three-Point Estimating. A technique used to estimate cost or duration by applying an average or weighted average of optimistic, pessimistic, and most likely estimates when there is uncertainty with the individual activity estimates.

Threshold. A predetermined value of a measurable project variable that represents a limit that requires action to be taken if it is reached.

Time and Material Contract (T&M). A type of contract that is a hybrid contractual arrangement containing aspects of both cost-reimbursable and fixed-price contracts.

To-Complete Performance Index (TCPI). A measure of the cost performance that is required to be achieved with the remaining resources in order to meet a specified management goal, expressed as the ratio of the cost to finish the outstanding work to the remaining budget.

Tolerance. The quantified description of acceptable variation for a quality requirement.

Tool. Something tangible, such as a template or software program, used in performing an activity to produce a product or result.

Tornado Diagram. A special type of bar chart used in sensitivity analysis for comparing the relative importance of the variables.

Total Float. The amount of time that a schedule activity can be delayed or extended from its early start date without delaying the project finish date or violating a schedule constraint.

Trend Analysis. An analytical technique that uses mathematical models to forecast future outcomes based on historical results.

Trigger Condition. An event or situation that indicates that a risk is about to occur.

Unanimity. Agreement by everyone in the group on a single course of action.

Update. A modification to any deliverable, project management plan component, or project document that is not under formal change control.

Validate Scope. The process of formalizing acceptance of the completed project deliverables.

Validation. The assurance that a product, service, or result meets the needs of the customer and other identified stakeholders. Contrast with *verification*.

Variance. A quantifiable deviation, departure, or divergence away from a known baseline or expected value.

Variance Analysis. A technique for determining the cause and degree of difference between the baseline and actual performance.

Variance At Completion (VAC). A projection of the amount of budget deficit or surplus, expressed as the difference between the budget at completion and the estimate at completion.

Variation. An actual condition that is different from the expected condition that is contained in the baseline plan.

Verification. The evaluation of whether or not a product, service, or result complies with a regulation, requirement, specification, or imposed condition. Contrast with *validation*.

Verified Deliverables. Completed project deliverables that have been checked and confirmed for correctness through the Control Quality process.

Virtual Teams. Groups of people with a shared goal who fulfill their roles with little or no time spent meeting face to face.

Voice of the Customer. A planning technique used to provide products, services, and results that truly reflect customer requirements by translating those customer requirements into the appropriate technical requirements for each phase of project product development.

WBS Dictionary. A document that provides detailed deliverable, activity, and scheduling information about each component in the work breakdown structure.

What-If Scenario Analysis. The process of evaluating scenarios in order to predict their effect on project objectives.

Work Breakdown Structure (WBS). A hierarchical decomposition of the total scope of work to be carried out by the project team to accomplish the project objectives and create the required deliverables.

Work Breakdown Structure Component. An entry in the work breakdown structure that can be at any level.

Work Package. The work defined at the lowest level of the work breakdown structure for which cost and duration are estimated and managed.

Work Performance Data. The raw observations and measurements identified during activities being performed to carry out the project work.

Work Performance Information. The performance data collected from controlling processes, analyzed in comparison with project management plan components, project documents, and other work performance information.

Work Performance Reports. The physical or electronic representation of work performance information compiled in project documents, intended to generate decisions, actions, or awareness.



INDEX

A

AC. *See* Actual cost

Acceptance criteria, 154, 698

Accepted deliverables, 166, 698

Accuracy, 182, 238, 698

Acquire Resources process, 328–335, 601–602
definition, 698
inputs, 330–331
outputs, 333–335
overview, 328–330
tools and techniques, 332–333

Acquisition, 698

Acronyms, common, 696–697

Action item tracking, 94, 110

Active listening, 104, 363, 372, 381, 386, 534

Active/passive risk acceptance strategies, 443–446

Activity

definition, 698

iterative, 33

Activity attributes, 698

as input, 188, 198, 207, 322, 573, 576, 583

as output, 186, 194, 204, 221, 327, 573, 575, 576, 583

Activity duration, 698

Activity duration estimates, 698. *See also* Estimate Activity Durations process

Activity identifier (ID), 188

Activity list

definition, 698

as input, 188, 198, 207, 322

as output, 185, 194

Activity-on-node (AON), 218, 698. *See also* Precedence Diagramming Method

Activity resource requirements. *See* Estimate Activity Resources process; Resource requirements

Activity sequencing. *See* Sequence Activities process

Actual cost (AC), 261, 698

Actual duration, 698

Adaptive environments

Project Communications Management and, 365

Project Cost Management and, 234

Project Integration Management and, 74

Project Procurement Management and, 465

Project Resource Management and, 311

Project Risk Management and, 400

Project Schedule Management and, 178

Project Scope Management and, 133

Project Stakeholder Engagement and, 506

Project Quality Management and, 276

Adaptive life cycles, 19, 698

ADR. *See* Alternative dispute resolution

Affinity diagram, 144, 293, 698

Agile approach

Control Schedule process and, 224

tailoring considerations, cost estimating, 234

Agile environments

Project Communications Management and, 365

Project Cost Management and, 234

Project Integration Management and, 74

Project Procurement Management and, 465

Project Resource Management and, 311

Project Risk Management and, 400

Project Quality Management and, 276

Project Schedule Management and, 178

Project Scope Management and, 133

Project Stakeholder Engagement and, 506

Agile release planning, 215
Agreements, 460, 698. *See also* Contract(s); Service level agreements
 as input, 78, 109, 125, 141, 208, 251, 355, 413, 496, 510, 519
 master services, 465
 as output, 489
Alternative dispute resolution (ADR), 498
Alternatives analysis, 111, 119, 202, 245, 292, 325, 356, 446, 533
 definition, 699
Ambiguity risk, 398, 399
Analogous estimating, 200, 244, 324, 699
Analytical techniques, 699
AON. *See* Activity-on-node
Approved change request, 115
 as input, 93, 300, 301, 495, 496
 as output, 120
 quality audits and, 295
 schedule baseline and, 229
Artifacts
 communication, 375
 project, 558–559
Assessments, individual and team, 342
Assets. *See* Organizational process assets (OPAs)
Assignment matrix (RAM), 317
Assumption(s), 33, 699
Assumption and constraint analysis, 415, 521
Assumption log
 definition, 699
 as input, 108, 124, 141, 152, 188, 198, 207, 280, 323, 412, 421, 430, 495, 519
 as output, 81, 97, 155, 194, 204, 221, 230, 247, 270, 320, 327, 358, 418, 427, 448, 458, 515
Attribute(s), 149
Attribute sampling, 274, 699
Audio conferencing, 340
Audits, 118, 276, 498
 configuration item verification and, 118
 procurement, 494, 714
 quality, 290, 294–295, 296, 718
 risk, 456, 458, 720
Authority, 699. *See also* Governance frameworks

Autocratic decision making, 119, 144
Automated tools, 73, 118
Avoidance, overall project risk and, 445

B

BAC. *See* Budget at completion
Backward pass, 210, 699
Bar chart, 217, 699
Baseline(s), 87, 699. *See also* Cost baseline; Scope baseline
Baseline schedule. *See* Schedule baseline
Basis of estimates, 108, 204, 699
 as input, 116, 124, 208, 250, 430
 as output, 229, 230, 247, 270, 326
Benchmarking, 143, 281, 699
Benefits management, project success and, 546–547
Benefits management plan, 33, 251, 469, 509, 699
Best practices
 benchmarking and, 143, 281, 399
 discretionary dependencies and, 191
Beta distribution, 245
Bid(s), 477. *See also* Proposals
 winning bidder and, 462
Bidder. *See* Seller(s)
Bidder conferences, 487, 699
Bid documents, 477, 485, 699
BIM. *See* Building information model
Body of knowledge (BOK), 1, 2, 69
BOK. *See* Body of knowledge
Bottom-up estimating, 324
 definition, 700
 description of, 202, 244
Brainstorming, 78, 80, 85, 142, 144, 281, 414, 416, 511
Brain writing, 511
Bubble chart, 425–426
Budget(s)
 definition, 700
 time-phased project, 87, 248, 254
Budget at completion (BAC), 261, 262, 264, 430, 700
Buffer. *See* Reserve
Building information model (BIM), 463
Burndown chart, 226

Business Analysis for Practitioners: A Practice Guide, 7, 33, 140

Business case

business documents and, 77–78

definition, 700

as input, 125, 251, 469, 509

project, 30–32

Business documents, 29–30

business case and, 77–78

definition, 559

as input, 125, 141, 251, 469, 509

project life cycle and, 30

project management, 29–30

Business environment, 10

Business management plan, 125

Business management skills, 58–60

PMI Talent Triangle® and, 56, 57

Business requirements, 148

Business value, 8, 10, 148

definition, 7, 700

state transition and, 6

Buyer

procurement process and, 461

seller and, 460–461

trial engagements and, 464

winning bidder, 462

Buyer-seller relationship, 461

C

CA. *See* Control account

Calendar. *See* Project calendar; Resource calendars

Cause-and-effect diagrams, 293, 294, 304, 700

CCB. *See* Change control board

Change(s)

contested, 498

definition, 700

projects and, 6

Change control. *See also* Perform Integrated Change

Control process

meetings, 120

procedures, 40

tools, 118–119, 700

Change control board (CCB), 115, 120, 700

Change control system, 700. *See also* Contract change control system

Change log

definition, 700

as input, 92, 124, 382, 510, 519, 525

as output, 529

Change management plan, 88, 116, 169, 495, 525, 700

Change request(s). *See also* Approved change request;

Change management plan; Perform Integrated Change

Control process; Requested change

approved change requests review, 305

components requiring, 171, 186, 221, 229, 287, 297,

351, 358, 387, 393, 490, 500, 515, 529

definition, 700

as input, 117, 301

as output, 96, 112, 166, 170, 186, 220, 228, 269, 296,

306, 334, 343, 350, 357, 393, 447, 451, 457, 479, 489,

499, 514, 528, 535

project baselines and, 115

status tracking, 124

tools and, 119

types of, 96, 112

Charter. *See* Develop Project Charter process; Project

charter; Team charter

Checklist(s), 85, 302, 414. *See also* Quality checklists

Checklist analysis, 700

Checksheets, 302, 700

Claim, 700

Claims administration, 498, 701

Closed procurements, 499

Close Project or Phase process, 121–128, 634–635

definition, 701

inputs, 124–126

outputs, 127–128

overview, 121–123

tools and techniques, 126–127

Closing Process Group, 23, 633–635

definition, 701

inputs and outputs, 634

overview of, 633

Code of accounts, 701

Code of Ethics and Professional Conduct, 3

- Collaboration
 - benefits of, 311–312
 - social computing and, 364
- Collect Requirements process, 138–149, 568–569
 - definition, 701
 - inputs, 140–141
 - outputs, 147–149
 - overview, 138–140
 - tools and techniques, 142–147
- Colocated teams, 340
- Colocation, 340, 343, 701
- Communication. *See also* Control Communications process; Organizational communication requirements; Plan Communications Management; Project Communications Management
 - 5 Cs of written, 361, 362–363
 - channels, 45, 209, 368, 370, 383, 391, 519, 526, 533
 - conversation, 145, 527
 - correspondence, 388, 496, 499
 - cross-cultural, 373
 - informal, 341
 - interactive, 374
 - language and, 365
 - leadership and, 61
 - mass, 374
 - nonverbal, 384
 - project, 92, 124, 387, 390, 532
 - skills, 363, 384, 527, 534
 - social computing and, 364, 373
 - successful, two parts of, 362
- Communication artifacts and methods, 375
- Communication competence, 363
- Communication methods, 374–375, 383, 701
 - artifacts and, 375
- Communication models, 371–373, 701
 - cross-cultural communication, 373
 - sample interactive, 371
- Communication planning, 333. *See also* Plan Communications process; Project Communications Management
- Communication requirements analysis, 369–370, 701
- Communications management, techniques and approaches, 381
- Communications management plan, 87, 377
 - approaches and, 374
 - communication forms and, 374
 - definition, 701
 - as input, 381, 390, 484, 509, 518, 525, 532
 - as output, 377, 387, 393, 490, 529, 535
- Communications technology, 365
- Communication styles, 373
- Communication styles assessment, 375, 701
- Communication technologies, 340, 370, 383, 506, 701.
 - See also* E-mail; Web conferencing
 - choice of, factors in, 370–371
 - tailoring considerations, 506
- Competence, 319
- Competencies
 - leadership skills, 60–63
 - leadership styles and, 65
 - management and, 64
 - overview, 56–57
 - personality and, 66
 - strategic and business management skills, 58–60
 - technical project management skills, 58
- Complexity
 - integration and, 68
 - procurement and, 465
 - project, 400
- Compliance
 - controlling PMOs and, 48
 - tailoring considerations and, 276
- Computer software. *See* Scheduling software; Software
- Conduct Procurements process, 482–491, 608–609
 - definition, 701
 - inputs, 484–486
 - outputs, 488–491
 - overview, 482–483
 - tools and techniques, 487–488
- Confidentiality
 - information and, 101, 102, 383
 - policies, 40
 - sensitivity and, 371
 - trust and, 282, 414, 422, 433, 442
- Configuration control, 115, 118
- Configuration items, change control and, 118

Configuration management plan, 88, 116, 169, 701
 as input, 484
 Configuration management systems, 41, 701
 Configuration verification and audit, 118
 Conflict management, 61, 80, 86, 341, 348–349, 386, 527
 Conformance. *See also* Nonconformance
 cost of, 283
 cost of quality and, 245, 274
 customer satisfaction and, 275
 definition, 701
 government standards and, 47
 Conformance work, 284, 289
 Connectivity, risk and, 424
 Constraints, 28, 39, 701
 Contested changes, 498
 Context diagrams, 146, 702
 Contingency, 702
 Contingency allowance. *See* Reserve
 Contingency plan, 72, 439, 445, 448
 Contingency reserve, 202, 245, 254, 439, 443, 702. *See also* Reserve analysis
 Contingent response strategies, 445, 702
 Contract(s), 460–461. *See also* Agreements; Time and Material Contract (T&M)
 administration of, 494
 closure of, 41, 126, 494, 633
 cost-reimbursable, 472, 703
 definition, 702
 fixed-price, 471, 707
 legally binding nature of, 461
 payment types and, 476
 procurement, 464, 494, 498, 501
 purchasing, 461
 termination clause, 489
 time and material, 472, 724
 types of, 471–472
 Contract change control system, 702
 Contracting processes, changing, 463
 Contract management systems, 110, 470, 486
 Contractor(s), 465. *See also* Seller(s); Subcontractors
 Contractor conferences. *See* Bidder conferences
 Contract payment types, 476
 Control account (CA), 161, 239, 254, 702
 Control chart, 304, 702
 Control/controlling, 107, 702
 Control Costs process, 257–270, 622–623
 definition, 702
 inputs, 259–260
 outputs, 268–270
 overview, 257–259
 tools and techniques, 260–268
 Control limits, 702. *See also* Specification limits
 Control Procurements process, 492–501, 629–631
 definition, 702
 inputs, 495–497
 outputs, 499–501
 overview, 492–494
 tools and techniques, 497–498
 Control Quality process, 298–306, 624–625
 definition, 702
 inputs, 300–302
 outputs, 305–306
 overview, 298–300
 tools and techniques, 302–305
 Control Resources process, 352–358, 625–626
 definition, 702
 inputs, 354–355
 outputs, 357–358
 overview, 352–354
 tools and techniques, 356–357
 Control Schedule process, 222–230, 621–622
 agile approach and, 224
 inputs, 224–225
 outputs, 228–230
 overview, 222–224
 tools and techniques, 226–228
 Control Scope process, 167–171, 619–620
 definition, 703
 inputs, 169–170
 outputs, 170–171
 overview, 167–168
 tools and techniques, 170
 Control thresholds, 181, 182, 239, 269
 Conversation, 145, 392, 527
 COQ. *See* Cost of quality
 Corporate knowledge base repositories, 95

Corrective action
 change request for, 96, 112
 definition, 703
 Correspondence, 388, 496, 499
 Cost(s). *See also* Actual cost
 failure, 274, 275, 282, 303
 indirect, 246, 261
 Cost aggregation, 252, 703
 Cost baseline
 definition, 703
 as input, 116, 259, 412, 430, 439, 484
 as output, 171, 186, 221, 229, 254–255, 269, 297, 334, 351, 358, 447, 490, 500
 Cost-benefit analysis, 111, 119, 282, 356, 446, 703
 Cost contingency reserve, 246
 Cost control. *See* Control Costs process
 Cost estimates. *See also* Estimate Costs process
 independent, 479, 485
 as input, 250, 323, 412, 430
 as output, 246, 256, 270
 Cost forecasts, 113, 269, 430, 448
 Cost management. *See* Project Cost Management
 Cost management plan, 87, 238
 definition, 703
 as input, 241, 250, 259, 411
 as output, 238, 269, 447
 Cost of quality (COQ), 245, 274, 282–283, 703
 Cost performance index (CPI), 263, 703
 Cost performance measurements, 262
 Cost plus award fee (CPAF) contract, 472
 Cost plus fixed fee (CPFF) contract, 472, 703
 Cost plus incentive fee (CPIF) contract, 472
 Cost-reimbursable contracts, 472, 703
 Cost variance (CV), 262, 703
 CPAF. *See* Cost plus award fee contract
 CPFF. *See* Cost plus fixed fee
 CPI. *See* Cost performance index
 CPIF. *See* Cost plus incentive fee (CPIF) contract
 CPM. *See* Critical path method
 Crashing, 215, 703
 Create WBS process, 156–162, 570–571. *See also* Work breakdown structure (WBS)
 definition, 703
 inputs, 157
 outputs, 161–162
 overview, 156–157
 tools and techniques, 158–161
 Criteria, 703
 Criticality index, 434
 Critical path, 209, 704
 Critical path activity, 704
 Critical path method (CPM), 210–211, 227, 704
 Critical success factors, 31
 Cross training, 337
 Cultural awareness, 376, 527, 534
 Cultural diversity, 338, 363
 Culture. *See* Organizational culture
 Customer(s). *See also* Voice of the Customer
 buyer becoming, 462
 external, 78
 Customer culture, 101
 Customer request, 78, 546
 Customer requirements, 20, 273
 Customer satisfaction, 275
 CV. *See* Cost variance

D

Daily standup meetings, 364
 Data. *See also* Work performance data
 definition, 704
 overview, 26–27
 Data analysis technique, 111, 119, 126, 136, 143, 153, 170, 181, 202, 213–214, 226, 238, 245, 252, 261, 282–283, 292, 303, 325, 356, 404, 415, 423, 433–436, 446, 456, 473, 487, 498, 512, 521, 533, 704
 Data date, 704
 Data gathering techniques, 80, 85, 142–143, 281–282, 292, 302–303, 414, 422, 432, 442, 473, 511, 520, 704
 Data representation techniques, 144, 284–285, 293–294, 304, 315, 316–317, 376, 392, 425–426, 512–513, 521–522, 534, 704
 Decision making
 business case and, 31
 effective, 349

- Decision-making techniques, 111, 119, 144, 153, 166, 203, 246, 283, 293, 446, 521, 534, 704
 - guidelines and, 349
 - selection criteria, 332
- Decision tree analysis, 435, 704
- Decoding/encoding of messages, 371
- Decomposition, 185. *See also* Work Breakdown Structure (WBS)
 - definition, 704
 - WBS components and, 160
 - into work packages, 158, 316
- Defect(s)
 - definition, 704
 - histograms and, 293, 304
- Defect repair, 96, 112, 704
- Define Activities process, 183–186, 572
 - definition, 704
 - inputs, 184
 - outputs, 185–186
 - overview, 183
 - tools and techniques, 184–185
- Define Scope process, 150–155, 569–570
 - definition, 704
 - inputs, 152
 - outputs, 154–155
 - overview, 150–151
 - tools and techniques, 153
- Deliverable(s). *See also* Result
 - accepted, 166, 698
 - definition, 704
 - as input, 101, 125, 301
 - output as, 21, 95, 154
 - project management and, 16, 22
 - projects and, 5
 - verified, 165, 305, 725
 - WBS structure and, 160
- Delivery methods, 476
- Deming, W. Edwards, 275
- Dependency. *See also* Logical relationship
 - definition, 704
 - mandatory, 191, 710
- Dependency determination
 - discretionary dependencies, 191
 - external dependencies, 192
 - integration and, 191–192
 - internal dependencies, 192
 - mandatory dependencies, 191
- Design for X (DfX), 295
- Design of experiments (DOE), 290
- Design reviews, 233
- Detectability, risk and, 424, 426
- Determine Budget process, 248–256, 578–579
 - definition, 704
 - inputs, 250–251
 - outputs, 254–256
 - overview, 248–249
 - tools and techniques, 252–253
- Development approach, 135, 180, 400, 704
- Development life cycle, 19, 74
- Develop Project Charter process, 75–81, 563
 - definition, 705
 - inputs, 77–79
 - outputs, 81
 - overview, 75–77
 - tools and techniques, 79–80
- Develop Project Management Plan process, 82–89, 567
 - definition, 705
 - inputs, 83–84
 - overview, 82–83
 - project management plan, 86–89
 - tools and techniques, 85–89
- Develop Schedule process, 205–221, 575–576
 - definition, 705
 - inputs, 207–209
 - outputs, 217–221
 - overview, 205–207
 - tools and techniques, 209–216
- Develop Team process, 336–344, 602–603
 - definition, 705
 - inputs, 339–340
 - outputs, 343–344
 - overview, 336–339
 - tools and techniques, 340–342
- DfX. *See* Design for X

Diagramming techniques, 705

Direct and Manage Project Work process, 90–97, 597–598
 definition, 705
 inputs, 92–94
 outputs, 95–97
 overview, 90–92
 tools and techniques, 94–95

Directions of influence, stakeholder analysis, 513

Discrete effort, 705

Discretionary dependencies, 191, 705

Disputes, 498

Disruptive conflict, 348

Distributed teams, 311

Diversity
 cultural, 311, 338
 stakeholder, 506

Document(s). *See also* Business documents; Procurement documents; Project documents
 bid, 477, 485, 699
 business, 29–30
 operational, 128
 project business case, 30–32
 test and evaluation, 296, 300, 303–304, 306, 724

Document analysis, 126, 292, 415, 512

Documentation. *See also* Lessons learned; Procurement documentation; Requirements documentation; Written communication
 bid documents, 699
 reviews, 705
 seller performance evaluation, 501
 technical, 125, 415, 499

DOE. *See* Design of experiments

Dormancy, risk and, 424

DU or DUR. *See* Duration

Duration (DU or DUR), 705. *See also* Most likely duration; Optimistic duration; Pessimistic duration

Duration estimates, 203. *See also* Estimate Activity Durations process
 as input, 208, 412, 430
 as output, 221

E

EAC. *See* Estimate at completion

EAC forecasts, 239, 264, 265

Early Finish date (EF), 210, 705

Early Start date (ES), 210, 705

Earned schedule (ES), 233

Earned value (EV), 261, 705

Earned value analysis (EVA), 111, 226, 261, 498
 calculations, summary table, 267

Earned value management (EVM)
 cost baseline for, 254
 definition, 705
 expansion of, 233
 rules of performance measurement, 182, 239, 254

Earned value performance indicators, 228

Ecological impacts, 78

Economic feasibility study, 30–32, 125

EEFs. *See* Enterprise environmental factors

EF. *See* Early Finish date

Effort, 705

Electronic communications management, 385

Electronic project management tools, 385

Email, 78, 311, 333, 340, 361, 362, 373, 374, 375, 376, 377, 385

E-meetings, 376, 377

Emerging practices. *See* Practices, emerging

Emotional intelligence (EI), 310, 349, 705

EMV. *See* Expected Monetary Value (EMV)

Encoding/decoding of messages, 371

Enhance strategy
 opportunity and, 444
 overall project risk and, 446

Enterprise environmental factors (EEFs), 37–39, 557
 definition, 706
 external to organization, 39
 as input, 78, 84, 93, 101, 109, 117, 135, 141, 152, 157, 180, 184, 189, 199, 209, 236–237, 243, 251, 280, 301, 315, 323, 331, 339, 348, 368, 383, 391, 403, 413, 422, 431, 441, 470, 486, 497, 510, 519, 526, 533
 internal to organization, 38
 organizational process assets and, 557
 as output, 335, 344, 351
 project influences and, 37

Environment, 37–49, 133. *See also* Adaptive environments; Agile environments; Enterprise environmental factors; Globalization/global environment management elements, 44–45 organizational process assets, 39–41 organizational structure types, 45–47 organizational systems, 42–44 overview, 37 project, 365, 371 regulatory, 465

Environmental consideration, 118, 546

ES. *See* Early Start date

Escalation, 355
opportunities and, 444
threats and, 442

Estimate(s). *See also* Analogous estimating; Basis of estimates; Independent estimates; Parametric estimating; Three-point estimate definition, 706 independent, 708 independent cost, 479

Estimate Activity Durations process, 195–204, 574–575 definition, 706 inputs, 198–199 overview, 195–197 tools and techniques, 200–204

Estimate Activity Resources process, 320–327, 582–583 definition, 706 inputs, 322–324 outputs, 325–327 overview, 320–322 tools and techniques, 324–325

Estimate at completion (EAC), 264–265, 706

Estimate Costs process, 240–247, 577–578 definition, 706 inputs, 241–243 outputs, 246–247 overview, 240–241 tools and techniques, 243–246

Estimate to complete (ETC), 706

ETC. *See* Estimate to complete

Ethics, 3

EV. *See* Earned value

EVA. *See* Earned value analysis

EVM. *See* Earned value management

Execute, 706

Executing Process Group, 23, 595–611
definition, 706
overview, 595
processes in, 596

Expected Monetary Value (EMV), 435

Expert judgment, 58, 85, 94, 102, 110, 118, 126, 136, 142, 153, 158, 181, 184, 200, 237, 243, 252, 260, 281, 315, 324, 369, 391, 404, 414, 422, 431, 441, 451, 472, 487, 497, 511, 520, 526, 706. *See also* Subject matter experts (SMEs)

Explicit knowledge, 100, 706

Exploit strategy
opportunity and, 444
overall project risk and, 445

External dependencies, 192, 706

External stakeholders, 361, 550

F

Facilitated workshops, 432

Facilitation, 80, 86, 104, 145, 381, 442

Failure costs, 274, 275, 282, 303

Fallback plan, 439, 445, 448, 706

Fast tracking, 191, 215, 228, 706

Feasibility study, 20, 30–32, 77, 125, 555

Fee, 706

Feedback, 384, 527, 534

FF. *See* Finish-to-finish

FFP. *See* Firm fixed price contract

Final product, service, or result, 127

Final report, 127–128

Financing, 253

Finish date, 210, 211, 706

Finish-to-finish (FF), 190, 706

Finish-to-start (FS), 190, 707

Firm Fixed Price Contract (FFP), 471, 707

Fishbone diagram, 293, 707. *See also* Cause-and-effect diagrams

Fixed-budget method, 474

Fixed formula method, 182, 239

Fixed-price contracts, 471, 707

Fixed Price Incentive Fee contract (FPIF), 471, 707
Fixed Price with Economic Price Adjustment contract (FPEPA), 471, 707
Float, 191, 210, 707, 725
Flowcharts, 284, 293, 707
Flow diagrams, process, 23
Focus groups, 80, 85, 142, 707
Forecast(s). *See also* Schedule forecasts
 cost, 113
 definition, 707
 EAC, 239, 264, 265
Forecasting, 264
Forecasting methods, 92, 220–221
Forming, storming, norming, performing, adjourning, 338
Forward pass, 210, 707
FPEPA. *See* Fixed Price with Economic Price Adjustment contract (FPEPA)
FPIF. *See* Fixed Price Incentive Fee contract
FPP. *See* Firm Fixed Price contracts
Free float, 707
FS. *See* Finish-to-start
Fully plan-driven life cycles. *See* Predictive life cycle
Functional manager
 project manager and, 52, 55, 325
 skills and, 332
Functional organization, 707
Functional requirements, 118, 148
Funding limit reconciliation, 253, 707
Funding requirements
 cost baseline, expenditures and, 255
 project funding, 256
Future state, transition state and, 6

G

Gantt chart, 217, 707
Generally recognized, 2
Globalization/global environment
 cultural diversity and, 338
 cultural influences and, 39
 international factors, 332
 virtual teams/distributed teams and, 311
Good practice, 2, 28

Governance, 28, 465. *See also* Organizational governance;
 Project governance
Governance frameworks, 43–44
 components of, 43
 portfolios, programs, projects and, 44
Governance of Portfolios, Programs, and Projects: A Practice Guide, 44
Government jurisdictions, 487. *See also* Regulatory bodies
Grade of products/services, 707
Graphical analysis techniques, 227, 263
Ground rules, project team, 320, 348, 528, 708
Group(s). *See also* Focus groups; Project Management Process Groups,
 projects and, 4
Guidelines, procurement, 471
Guide to the Project Management Body of Knowledge, A (PMBOK® Guide)
 components of, 17–18
 development of, 69
 foundation and framework for, 541
 overview of industry standard, 1–2
 purpose of, 2

H

Hierarchical charts, 316, 425–426
High-level project/product description, 81, 135, 140, 152, 279, 314, 402
High-level requirements, 80, 81, 135, 140, 149, 402
Histograms, 293, 304, 708
Historical information
 definition, 708
 lessons learned and, 41, 74
 review, 253
Human resource management. *See* Project Resource Management
Hybrid life cycle, 19
Hybrid methodologies, 73

I

ID. *See* Activity identifier
Identified risks. *See also* Risk register

contingency reserves and, 245
 cost estimates and, 246, 247
 list of, 417
 reserve analysis and, 265
 risk breakdown structure and, 405
 risk perception and, 420
 SWOT analysis and, 415

Identify Risks process, 409–418, 586–587
 definition, 708
 inputs, 411–413
 outputs, 417–418
 overview, 409–411
 tools and techniques, 414–416

Identify Stakeholders process, 507–515, 563–564
 definition, 708
 inputs, 509–510
 outputs, 514–515
 overview, 507–508
 tools and techniques, 511–514

IFB. *See* Invitation for bid

Impact scales, risk and, 426

Impact value, 426. *See also* Probability and impact matrix

Implementing Organizational Project Management: A Practice Guide, 17

Implement Risk Responses process, 449–452, 607
 definition, 708
 inputs, 450
 outputs, 451–452
 overview, 449–450
 tools and techniques, 451

Imposed date, 708

Improvement
 continual, 275
 continuous, 276
 quality, 275, 296

Incentive fee, 708

Incremental life cycle, 19, 708

Independent cost estimates, 479, 485

Independent estimates, 708

Indirect costs, 246, 261

Individual project risk, 397

Industry, project manager and, 55

Inflation, 243

Inflation allowance, 241, 246

Influence, directions of, 513

Influence diagram, 436, 708

Influence/impact grid, stakeholder analysis, 512

Influencing skills, 341, 350, 357

Information, 708. *See also* Documentation; Historical information; Project information
 confidentiality/sensitivity of, 371
 project management data and, 26–27
 urgency of need for, 370
 work performance, 26

Information management systems, 708. *See also* Project Management Information System

Information-sharing procedures, formal, 102

Information storage and retrieval. *See* Corporate knowledge base repositories

Information system. *See* Project Management Information System

Initiating Process Group, 23, 561–564
 definition, 708
 overview, 561–562
 project boundaries and, 562

Initiating project
 context for, 7–9
 processes, procedures and, 40

Input(s). *See also specific process*
 definition, 708
 project management processes and, 22, 555

Inspection(s)
 definition, 708
 description of, 166, 303, 498
 planning for, 285
 prevention and, 274

Integrated change control. *See* Perform Integrated Change Control process

Integrated risk management, 399

Integration, 66–68. *See also* Project Integration Management
 cognitive level and, 67
 complexity and, 68
 context level and, 67
 overview, 66
 process level and, 67

Intellectual property rights, 470, 480, 483, 485, 491, 495
Interactive communication, 374
Interdependencies, 14, 16, 102–103
Internal dependencies, 192
Internal rate of return (IRR), 34, 473
Internal stakeholders, 550
Interpersonal and team skills, 709
Interpersonal communication, 374
Interpersonal skills, 144–145, 153
 definition, 709
 “soft” skills, 53
 team skills and, 332–333, 341, 348–350, 357, 375–376, 386, 392, 416, 424, 432, 442, 451, 488, 527, 534
 types of, 80, 104, 534, 552
Interviews, 80, 85, 142, 282, 414, 432, 709
Invitation for bid (IFB), 709
IRR. *See* Internal rate of return
Ishikawa diagrams, 293
Issue, 709
Issue log
 definition, 709
 as input, 124, 347, 354, 382, 390, 412, 455, 510, 519, 525, 532
 as output, 96, 113, 297, 306, 351, 358, 387, 393, 418, 427, 452, 458, 515, 529, 536
Iteration backlog, 203, 226
Iteration burndown chart, 226
Iteration length, 182
Iteration planning, 215
Iterative activity, 33
Iterative life cycle, 19, 151, 709
Iterative planning technique, 185, 721
Iterative process, 205, 209, 411

J

JAD. *See* Joint application design/development (JAD) sessions
JIT. *See* Just-in-time
“Job shadowing,” 145
Joint application design/development (JAD) sessions, 145
Joint venture, 444, 445, 476
Judgment. *See* Expert judgment

K

Kaizen, 310
Kanban system, 177
Key concepts
 Project Communications Management and, 360–363
 Project Cost Management and, 233
 Project Integration Management and, 72
 Project Procurement Management and, 460–462
 Project Quality Management and, 273–275
 Project Resource Management and, 309–310
 Project Risk Management and, 397–398
 Project Schedule Management and, 175
 Project Scope Management and, 131
 Project Stakeholder Engagement and, 504–505
Key performance indicators (KPIs), 95, 389
Key stakeholder list, 81, 314, 368, 509
Knowledge, 709. *See also* Manage Project Knowledge process
 body of, 1
 explicit, 100, 706
 product, management of, 73
 project management and, 16
 project manager and, 52
 repositories for, 41
 tacit, 100, 724
Knowledge Areas, 23–25, 553
 mapping of, 24–25, 556
 overview, 23–25
 PMBOK® Guide key components and, 18
 Process Groups and, 24–25, 556
Knowledge management, 133, 365
 misconceptions, 100
 product, 73
 project, 73
 tools and techniques, 103
Known risks, 31, 399
“Known-unknowns,” 202, 245
KPIs. *See* Key performance indicators

L

Lag(s)

- adjusting, 228
- definition, 193, 709
- example of, 192
- leads and, 192–193, 214

Language, 365

Late finish date (LF), 210, 709

Late start date (LS), 210, 709

Law of diminishing returns, 197

Lead(s)

- adjusting, 228
- definition, 192, 709
- example of, 192
- lags and, 192–193, 214

Leader(s), qualities and skills of, 61–62

Leadership, 534

- management compared to, 64–66
- styles, 65

Leadership skills, 60–63, 350

- getting things done, 62–63
- people, dealing with, 60
- PMI Talent Triangle® and, 56, 57
- politics, power and, 62–63
- qualities and, 61–62

Lean Six Sigma, 275

Least cost method, 473

Legal requirements, 78, 369, 370

Legal rights, 512

Lessons learned, 208. *See also* Retrospectives

- definition, 709
- meetings, 305
- tailoring considerations, 74

Lessons learned register

- definition, 709
- description of, 104
- as input, 92, 101, 108, 124, 141, 165, 169, 198, 208, 225, 242, 291, 300, 339, 347, 354, 382, 390, 412, 440, 450, 455, 484, 495, 525, 532
- as output, 97, 104, 113, 167, 171, 204, 221, 230, 247, 270, 287, 297, 306, 327, 335, 344, 351, 358, 387, 393, 418, 448, 452, 458, 480, 491, 500, 529, 536

Lessons learned repository

- definition, 709
- as output, 128, 501

Leveling. *See* Resource leveling

Level of accuracy, 182, 238

Level of effort (LoE), 300, 325, 450, 709

Level of precision, 238

Lexicon. *See* PMI Lexicon of Project Management Terms

LF. *See* Late finish date

Life cycle. *See also* Iterative life cycle; Predictive life cycle;

- Product life cycle; Project life cycle
- attributes and, 20
- definition, 710
- development, 19, 74
- incremental, 19, 708
- iterative, 19, 151, 709
- predictive, 19, 714

Life cycle approach, 178, 311

Listening techniques, 386, 534. *See also* Active listening

LoE. *See* Level of effort

Log, 710. *See also* Issue log

Logical data model, 284

Logical relationship, 710. *See also* Precedence Diagramming Method (PDM); Precedence relationship

Logic bar chart, 218

Logistics, 464

Long-lead items, 464

LS. *See* Late start date

M

Majority, 144

Make-or-buy analysis, 473, 476, 710

Make-or-buy decisions, 473, 479, 710

Make versus buy decision, 241

Manageability, risk and, 424

Manage Communications process, 379–388, 605–606

- definition, 710
- inputs, 381–383
- outputs, 387–388
- overview, 379–381
- tools and techniques, 383–386

Management. *See also* Conflict management; Portfolio management; Program management; Project management; Project Quality Management leadership compared to, 64–66
 meetings and, 80, 86, 386
 project knowledge, 73
 risk, 399, 463
 social media, 385
 supply chain, 464
 team, 311
 Management elements, 44–45
 Management reserves, 202, 248, 252, 254, 256, 265, 405, 710
 Management responsibility, 275
 Management skills, 710
 Manage Project Knowledge process, 98–105, 598–599
 definition, 710
 inputs, 100–102
 outputs, 104–106
 overview, 98–100
 tools and techniques, 102–104
 Manage Quality process, 288–297, 599–600
 definition, 710
 inputs, 290–291
 outputs, 296–297
 overview, 288–290
 tools and techniques, 292–296
 Manager(s). *See also* Project manager
 functional, 53, 55, 325, 332
 portfolio, 13
 program, 11, 29, 55
 Manage Stakeholder Engagement process, 523–529, 610–611
 definition, 710
 inputs, 525–526
 outputs, 528–529
 overview, 523–524
 tools and techniques, 526–528
 Manage Team process, 345–351, 604–605
 definition, 710
 inputs, 347–348
 outputs, 350–351
 overview, 345–346
 tools and techniques, 348–350
Managing Change in Organizations: A Practice Guide, 6
 Mandatory dependencies, 191, 710
 Market conditions, 243
 Market demand, 78
 Market research, 473
 Mass communication, 374
 Master schedule, 217, 710
 Master services agreement (MSA), 465
 Matrix diagrams, 284, 293, 710
 Matrix organization(s), 710
 Matrix project environment, 329
 Measure, units of, 182, 238
 Measurement. *See* Metrics; Quality control measurements; Quality metrics
 Media, choice of, 381
 Meetings, 80, 95, 111, 127, 136, 181, 185, 238, 286, 318, 325, 342, 404
 activity durations and, 203
 approved change requests review, 305
 change control, 120
 change control board and, 120
 management of, 80, 86, 381, 386
 project, 364
 project kick-off, 86
 project management plan and, 86
 project-related, 364, 376
 quality control and, 305
 retrospectives/lessons learned, 305
 risk analysis and, 426
 risk identification and, 416
 risk review, 457
 types of, 528
 Megaprojects, 11, 463
 Memorandums of understanding (MOUs), 78, 461
 Methodology, 2, 711
 Metrics. *See also* Quality control measurements; Quality metrics
 benefits management plan and, 33
 project success and, 34–35
 work performance, 109
 Milestone, 711
 Milestone charts, 218

Milestone list
as input, 92, 108, 124, 188, 198, 208, 430, 469, 495
as output, 186, 194, 480
Milestone schedule, 711. *See also* Master schedule
Mind-mapping, 144, 284, 521, 711
Mitigation. *See* Risk mitigation
Modeling techniques, 209, 431
Monitor and Control Project Work process, 105–113, 615–616
definition, 711
inputs, 107–110
outputs, 112–113
overview, 105–107
tools and techniques, 110–111
Monitor Communications process, 388–393, 627–628
definition, 711
inputs, 390–391
outputs, 392–393
overview, 388–389
tools and techniques, 391–392
Monitoring and Controlling Process Group, 23, 613–632
definition, 711
overview, 613
processes in, 614
Monitor, 711
Monitor Risks process, 453–458, 628–629
definition, 711
inputs, 455–456
outputs, 457–458
overview, 453–454
tools and techniques, 456–457
Monitor Stakeholder Engagement process, 530–536, 631–632
definition, 711
inputs, 532–533
outputs, 535–536
overview, 530–531
tools and techniques, 533–535
Monte Carlo analysis, 213–214, 399, 433, 436
Monte Carlo simulation, 214, 711
Morale, 45, 338
Most likely duration, 201

Motivation
behaviors and, 60
conflict management and, 348
leadership and, 65, 309
staff and, 197
team skills and, 341
user stories and, 145
MOUs. *See* Memorandums of understanding
MSA. *See* Master services agreement
Multicriteria Decision Analysis, 119, 144, 534, 711
Multiphase projects, 86

N

Navigating Complexity: A Practice Guide, 68
Negative risks, 395, 397
Negotiation, 341, 357, 488, 527
Net present value (NPV), 34, 473
Network(s), 711. *See also* Project schedule network diagram
social computing communication and, 374
Network analysis. *See* Schedule network analysis
Networking, 386, 534, 711
Networking skills, 104, 534
Network logic, 218, 711
Network path, 210, 711. *See also* Critical path method (CPM)
Node, 189, 435, 711
Nominal group technique, 144–145, 712
Nonconformance
costs and, 245, 282, 283
prevention of, 274
problems, 303
work, 284
Nonverbal communication, 384
NPV. *See* Net present value

O

Objective, 712
OBS. *See* Organizational breakdown structure
Observation/conversation, 145, 527
On-demand scheduling, 177
OPAs. *See* Organizational process assets (OPAs)
Operational documents, 128

- OPM. *See* Organizational Project Management
 - Opportunities, 397, 712
 - strategies for, 444
 - Optimistic duration, 201
 - Organizational breakdown structure (OBS), 316, 712
 - Organizational charts, 370
 - Organizational communication requirements, 40, 102, 369, 383, 391, 520, 525, 533
 - Organizational culture, 38. *See also* Cultural diversity
 - Organizational governance
 - frameworks, 43–44
 - project governance and, 545
 - Organizational knowledge base. *See* Corporate knowledge base repositories
 - Organizational knowledge repositories, 41
 - Organizational learning, 712
 - Organizational procedures links, 182, 239
 - Organizational process assets (OPAs)
 - categories of, 39–40
 - definition, 712
 - enterprise environmental factors and, 557
 - as input, 79, 84, 94, 102, 110, 117, 136, 141, 152, 157, 170, 180, 184, 189, 199, 209, 225, 237, 243, 251, 260, 281, 291, 302, 314, 324, 331, 340, 348, 355, 369, 383, 391, 403, 413, 422, 431, 441, 450, 471–472, 486, 497, 510, 520, 526, 533
 - as output, 105, 128, 335, 344, 388, 458, 481, 491, 501
 - processes, policies, and procedures, 40–41
 - project influences and, 37
 - Organizational project management (OPM)
 - definition, 544
 - governance framework, 44
 - purpose of, 17
 - strategies and, 16–17
 - Organizational strategy
 - expert judgment and, 79
 - portfolio structure and, 12
 - Organizational structure(s), 42, 44. *See also* Project management office
 - functional organization, 707
 - hierarchical, 45
 - matrix organizations, 710
 - project characteristics and, 47
 - reporting relationships and, 319, 329
 - selection of, factors in, 46
 - types of, 45–47
 - Organizational systems, 42–44
 - governance frameworks and, 43–44
 - overview, 42–43
 - Organizational theory, 318
 - Organization charts and position descriptions, 316–317
 - hierarchical-type charts and, 316
 - matrix-based charts, 317
 - text-oriented formats, 317
 - Output(s). *See also specific process*
 - definition, 712
 - project management processes and, 22, 555
 - Overall project risk, 397, 712
 - strategies for, 445–446
 - Overlapping project phases, 19, 547
- P**
- Parameters. *See* Project characteristics
 - Parametric estimating, 200–201, 244, 324, 712
 - Path convergence, 194, 712
 - Path divergence, 194, 712
 - Payback period (PBP), 34, 473
 - Payment schedules and requests, 501
 - Payment types, contract, 476
 - PBOs. *See* Project-based organizations (PBOs)
 - PBP. *See* Payback period
 - PDCA. *See* Plan-do-check-act (PDCA) cycle
 - PDM. *See* Precedence Diagramming Method
 - PDPC. *See* Process Decision Program Charts (PDPC)
 - Percent complete, 712
 - Performance appraisals, 126, 344, 351
 - Performance assessment. *See* Team performance assessments
 - Performance measurement, rules of, 239
 - Performance measurement baseline (PMB), 88, 621, 712
 - as input, 169, 224, 259
 - as output, 171, 229, 269, 620
 - Performance reporting, 175, 478, 489. *See also* Work performance reports
 - Performance reviews, 227, 303, 356, 498, 712
 - Performing integration. *See* Integration

Performing organization, 39, 40, 271, 332. *See also* Seller(s)

Perform Integrated Change Control process, 113–120, 616–617
 definition, 712
 inputs, 116–117
 outputs, 120
 overview, 113–115
 tools and techniques, 118–120

Perform Qualitative Risk Analysis process, 419–427, 588–589
 definition, 712
 inputs, 421–422
 outputs, 427
 overview, 419–421
 tools and techniques, 422–426

Perform Quantitative Risk Analysis process, 428–436, 589–590
 definition, 713
 inputs, 430–431
 outputs, 436
 overview, 428–429
 tools and techniques, 431–436

Phase. *See* Project phase(s)

Phase closure, 126, 127, 128. *See also* Close Project or Phase process

Phase gate
 definition, 713
 description of, 21

Physical resource assignments, 333, 354, 358, 626

Plan Communications Management, 366–378
 inputs, 368–369
 outputs, 377–378
 overview, 366–367
 tools and techniques, 369–376

Plan Communications Management process, 584–585, 713

Plan Cost Management process, 235–239, 577
 definition, 713
 inputs, 236–237
 outputs, 238–239
 overview, 235–236
 tools and techniques, 237–238

Plan-do-check-act (PDCA) cycle, 275

Planned value (PV), 261, 713

Planning package, 161, 713. *See also* Control account

Planning Process Group, 23, 565–594
 definition, 713
 overview, 565–566
 processes in, 566

Plan Procurement Management process, 466–481, 592–593
 definition, 713
 inputs, 468–472
 outputs, 475–481
 overview, 466–468
 tools and techniques, 472–474

Plan Quality Management process, 277–287, 580–581
 definition, 713
 inputs, 279–281
 outputs, 286–287
 overview, 277–278
 tools and techniques, 281–286

Plan Resource Management process, 312–320, 581–582
 definition, 713
 inputs, 314–315
 outputs, 318–320
 overview, 312–313
 tools and techniques, 315–318

Plan Risk Management process, 401–408, 585
 definition, 713
 inputs, 402–403
 outputs, 405–408
 overview, 401–402
 tools and techniques, 404

Plan Risk Responses process, 437–448, 590–592
 definition, 713
 inputs, 439–441
 outputs, 447–448
 overview, 437–439
 tools and techniques, 441–446

Plan Schedule Management process, 179–182, 571–572
 definition, 713
 inputs, 180
 outputs, 181–182
 overview, 179
 tools and techniques, 181

- Plan Scope Management process, 134–137, 567–568
 - definition, 713
 - inputs, 135–136
 - outputs, 137
 - overview, 134–135
 - tools and techniques, 136
- Plan Stakeholder Engagement process, 516–522, 594
 - definition, 713
 - inputs, 518–520
 - outputs, 522
 - overview, 516–518
 - tools and techniques, 520–522
- Plurality, 144, 714
- PM. *See* Project manager
- PMB. *See* Performance measurement baseline
- PMBOK® Guide*. *See* Guide to the Project Management Body of Knowledge
- PMI Lexicon of Project Management Terms*, 3
- PMIS. *See* Project Management Information System
- PMI Talent Triangle®, 56–57
- PMO. *See* Project management office
- Policy
 - definition, 714
 - processes, procedures and, 40–41, 102
 - procurement, 471
- Political awareness, 104, 376, 386, 527, 534
- Politics, leadership skills and, 62–63
- Portfolio(s)
 - definition, 11, 15, 714
 - governance of, 44
 - programs, projects and, 11–13, 543–544
- Portfolio management
 - definition, 15, 714
 - description of, 15
 - organizational strategies and, 16
 - program management and, 11, 12
- Portfolio Management, The Standard for*, 3, 15, 33
- Portfolio manager, 13
- Positive risks, 395, 397
- Practice, 714
- Practices, emerging
- Project Communications Management and, 364
- Project Cost Management, 233
- Project Integration Management and, 73
- Project Procurement Management and, 463–464
- Project Quality Management and, 275
- Project Resource Management and, 310–311
- Project Risk Management and, 398–399
- Project Schedule Management and, 177
- Project Scope Management and, 132
- Project Stakeholder Engagement and, 505
- Practice Standard for Earned Value Management*, 182
- Practice Standard for Earned Value Management – Second Edition*, 239
- Practice Standard for Scheduling*, 175, 178, 207, 214
- Practice Standard for Work Breakdown Structures – Second Edition*, 161
- Preapproved seller lists, 471
- Pre-assignment of team members, 333
- Pre-bid conferences. *See* Bidder conferences
- Precedence Diagramming Method (PDM), 189–190
 - critical paths and, 210
 - definition, 714
 - relationship types, 190
- Precedence relationship. *See also* Logical relationship
 - definition, 714
 - internal dependencies and, 192
- Precision, level of, 238
- Predecessor activity, 194, 714
- Predictive life cycle, 19, 131, 714
- Preferred logic/preferential logic, 191. *See also* Discretionary dependencies
- Prequalified seller lists updates, 501
- Presentations, 381, 384, 534
- Preventive action
 - change request for, 96, 112
 - definition, 714
 - inspection and, 274
- Probability and impact matrix, 425
 - definition, 714
 - scoring scheme and, 408
- Probability distributions, 432
 - cumulative (S-curve), 433
 - influence diagram and, 436
 - simulation and, 213
 - target milestone and, 214
 - variability risks and, 399

Problem solving, 295, 356
 Procedure(s)
 definition, 714
 processes, policies and, 40–41
 procurement, 471
 Process(es), 714
 Process analysis, 292
 Process assets. *See* Organizational process assets
 Process closure. *See* Closing Process Group
 Process flow diagrams, 23, 284
 Process Groups. *See* Project Management Process Groups
 Process level, integration at, 67
 Procurement(s)
 closed, 499
 complexity of, 465
 phases, 476
 Procurement audit, 494, 714
 Procurement closure, formal, 125, 499
 Procurement contract, 464, 494, 498, 501
 Procurement documentation, 485
 comparison of, 481
 definition, 714
 as input, 496
 as output, 499
 Procurement documents
 definition, 714
 as input, 125, 413
 procurement contract, 464, 494, 498, 501
 Procurement file, 501
 Procurement management plan, 87, 125
 definition, 714
 as input, 330, 484, 495
 as output, 447, 475, 490, 500
 Procurement negotiation, 488
 Procurement phases, 476
 Procurement policies, formal, 471
 Procurement statement of work, 477–478, 485, 715
 Procurement strategy, 476, 715
 Product(s)
 definition, 715
 final, 127
 projects and, 4
 Product analysis, 153, 715
 Product backlog, 131, 203
 Product evaluations. *See* Test and evaluation documents
 Product life cycle
 cost of quality and, 245
 definition, 715
 Product requirements
 brainstorming and, 142
 facilitation and, 145
 industry specific, 140
 meeting, 552
 requirements traceability matrix and, 93, 148, 280, 470
 Product reviews, 166
 Product roadmap, 215–216
 Product scope, 115, 131, 715
 Product vision, 216
 Professional conduct, 3
 Program(s)
 definition, 11, 715
 governance of, 44
 portfolios, projects and, 11–13, 543–544
 Program management
 definition, 715
 description of, 14
 portfolio management and, 11
 Program Management, The Standard for, 3, 14, 33
 Program manager, 11, 29, 55
 Progressive elaboration, 147, 185, 186, 565, 715
 Project(s), 4–9
 boundaries, 562
 complex, 461
 definition, 4, 542, 715
 funding requirements, 256
 initiation of, 546
 multiphase, 86
 portfolios, programs and, 11–13, 543–544
 Project artifacts, tailoring, 558–559
 Project boundaries, 562
 Project budget components, 255
 Project business case, 30–32
 Project calendar, 220, 225, 715
 Project characteristics, 47, 253

Project charter. *See also* Develop Project Charter process;
 Key stakeholder list
 definition, 715
 elements of, 155
 as input, 83, 124, 135, 140, 152, 180, 236, 279, 314, 368, 402, 468, 509, 518
 management plan and, 34
 as output, 81

Project closure. *See also* Close Project or Phase process
 documents, 128
 guidelines, 41

Project communication(s), 92, 124, 387
 as input, 390, 532

Project communication requirements. *See* Communication requirements analysis

Project Communications Management, 24, 359–365
 agile/adaptive environments and, 365
 definition, 715
 key concepts for, 360–363
 overview, 360
 processes in, 359
 tailoring considerations, 365
 trends and emerging practices, 364

Project complexity, 400

Project constraints. *See* Constraints

Project cost control. *See* Control Costs process

Project Cost Management, 24, 231–234
 agile/adaptive environments and, 234
 definition, 715
 key concepts for, 233
 overview, 231–232
 processes in, 231
 tailoring considerations, 234
 trends and emerging practices, 233

Project dimensions, 178

Project documents
 as input, 92–93, 101, 108, 116, 124, 141, 152, 157, 165, 169, 188, 198, 207–208, 225, 242, 250, 260, 280, 291, 300, 314, 322, 331, 339, 347, 354, 368, 382, 390, 403, 412–413, 421, 430–431, 440, 450, 455, 469–470, 484–485, 495, 510, 519, 525, 532
 as output, 97, 113, 120, 127, 128, 155, 162, 167, 171, 194, 204, 221, 230, 247, 256, 270, 287, 297, 306, 320, 327, 335, 344, 351, 358, 378, 387, 393, 418, 427, 436, 448, 452, 458, 480, 491, 500, 515, 529, 536
 project management plan and, 89, 559

Project environment, 365, 371. *See also* Adaptive environments; Agile environments

Project execution. *See* Executing Process Group

Project funding requirements
 definition, 715
 as input, 260
 as output, 256

Project governance
 definition, 44, 715
 organizational governance and, 545

Project importance, 400

Project initiation
 context, 7–9
 definition, 716

Project Integration Management, 23. *See also specific process*
 agile/adaptive environments, 74
 definition, 716
 key concepts, 72
 overview, 69–71
 processes in, 70
 tailoring considerations, 74
 trends and emerging practices, 73

Project life cycle, 19, 547–549
 adaptive, 19, 131, 698
 definition, 716

Predictive, 19, 131, 714
 project management plan and, 135

Project management. *See also* Organizational project management
 definition, 10, 716
 importance of, 10–11
 Knowledge Areas, 23–25
 processes, 22

Process Groups in, 23–25

Project management body of knowledge, 1, 2, 69, 716

Project Management Information System (PMIS), 26, 95, 193, 216, 227, 246, 268, 325, 350, 357, 385, 392, 451, 716

Project Management Knowledge Areas, 23–25, 553, 716

Project management office (PMO), 40, 48–49, 716

Project management plan, 86–89, 403. *See also* Develop

Project Management Plan process

- baselines, 87
- components and, 88, 116, 135, 165, 169, 279, 314, 368, 411–412, 564, 568, 569, 570, 572, 573, 574, 575, 577, 578, 579, 580, 582, 583, 584, 585, 586, 588, 589, 591, 593, 594, 597, 599, 600, 601, 603, 604, 606, 607, 608, 610, 615, 617, 618, 619, 621, 623, 624, 626, 627, 629, 630, 632, 634
- definition, 716
- as input, 92, 100, 107, 116, 123, 135, 140, 152, 157, 165, 169, 180, 184, 188, 198, 207, 224, 236, 241–242, 250, 259, 279, 290, 300, 314, 322, 330, 339, 347, 354, 368, 381, 390, 411, 421, 430, 439, 450, 455, 469, 484, 495, 509, 518, 525, 532, 568, 572, 621
- as output, 97, 105, 112, 120, 171, 186, 221, 229, 269, 287, 297, 306, 334, 343, 351, 358, 378, 387, 393, 447, 457, 490, 500, 515, 529, 535, 564, 572, 576, 581, 584, 591, 598, 599, 600, 602, 603, 605, 606, 607, 609, 611, 616, 617, 620, 622, 623, 625, 626, 628, 629, 631, 632
- subsidiary management plans, 87

Project Management Process Groups, 23, 554–556

- categories of, 23
- definition, 716
- Knowledge Area mapping and, 24–25, 556
- PMBOK* key components and, 18
- project/phase interactions and, 555

Project management software, 188, 194, 377, 385

Project management system, 391, 716

Project management team, 716. *See also* Project team(s)

Project manager (PM). *See also* Competencies;

- Leadership skills
 - competencies of, 56–66
 - definition, 716
 - leadership styles and, 65
 - overview, 51–52
 - responsibilities, 73
 - role of, 51–52, 66, 551
 - skills and, 52
 - sphere of influence, 52–56

Project Manager Competency Development (PMCD) Framework, 56

Project meetings, 364

Project organization chart, 319, 716

Project performance appraisals, 342

Project phase(s)

- definition, 20, 716
- overview, 20–21
- phase names and, 20

Process Groups and, 555

Project portfolio, 11

Project presentations, 385

Project Procurement Management, 24, 459–465

- agile/adaptive environments and, 465
- definition, 717
- key concepts for, 460–462
- overview, 460
- processes in, 459
- tailoring considerations, 465
- trends and emerging practices, 463–464

Project Quality Management, 24, 271–276. *See also*

- Quality management plan
 - agile/adaptive environments and, 276
 - definition, 717
 - interrelations, major, 273
 - key concepts for, 273–275
 - overview, 271–273
 - tailoring considerations, 276
 - trends and emerging practices, 275

Project records, 41, 79, 109, 388, 494

Project reporting, 385

Project reports, 123, 361, 362, 388

Project requirements, 148

Project Resource Management, 24, 307–312. *See also*

- Employees
 - agile/adaptive environments and, 311–312
 - definition, 717
 - key concepts for, 309–310
 - overview, 307–309
 - tailoring considerations, 311
 - trends and emerging practices, 310–311

Project risk(s)

- individual, 397
- overall, 397, 445–446, 712
- prioritized list of, 436

- Project risk exposure, assessment of, 436
- Project Risk Management, 24, 395–400
 - agile/adaptive environments and, 400
 - definition, 717
 - key concepts for, 397–398
 - overview, 396
 - processes in, 395
 - tailoring considerations, 400
 - trends and emerging practices, 398–399
- Project schedule
 - definition, 717
 - as input, 93, 225, 242, 250, 314, 331, 339, 355, 440, 484, 519
 - as output, 217–219, 230, 256, 335, 344, 378, 387, 448
- Project Schedule Management, 24, 173–178
 - agile/adaptive environments and, 178
 - definition, 717
 - key concepts, 175
 - overview of, 174
 - processes, 173
 - scheduling overview, 176
 - tailoring considerations, 178
 - trends and emerging practices, 177
- Project schedule model
 - development, 182
 - maintenance, 182, 208
 - schedule data for, 220
 - schedule network analysis and, 209
 - target, 217
- Project schedule network diagram
 - definition, 717
 - description of, 193–194, 218
 - as input, 208
 - lag and, 193
 - as output, 194, 218
- Project schedule presentations, example, 219
- Project scope, 131. *See also* Control Scope process; Define Scope process; Verify Scope process
 - change requests and, 115
 - definition, 717
 - description, 154
- Project Scope Management, 23, 129–133
 - agile/adaptive environments and, 133
 - definition, 717
 - key concepts for, 131
 - overview, 130
 - processes, 129
 - tailoring considerations, 133
 - trends and emerging practices, 132
- Project scope statement
 - definition, 717
 - elements of, 155
 - as input, 157
 - as output, 154, 161
- Project size, 400
- Project sponsor, 29
- Project Stakeholder Engagement, 24, 503–506
 - agile/adaptive environments and, 506
 - definition, 717
 - key concepts for, 504–505
 - overview, 503–504
 - tailoring considerations, 506
 - trends and emerging practices, 505
- Project stakeholder(s), 550–551
 - examples of, 551
 - external, 550
 - internal, 550
- Project statement of work. *See* Statement of work
- Project success
 - benefits management and, 546–547
 - failure or, 123, 504
 - measures of, 34–35
- Project team assignments, 339, 344, 347
 - as input, 440, 469
 - as output, 351, 448, 452
- Project team(s), 717. *See also* Manage Project Team process; Team(s); Virtual teams
 - assignments, 198, 208
 - development objectives, 338
 - resource management, 319
- Project team directory, 717
- Proposal(s). *See* Seller proposals
- Proposal evaluation techniques, 717
- Prototypes, 147, 717
- Pull communication, 374
- Purchasing contract, 461
- Push communication, 374
- PV. *See* Planned value

Q

QFD. *See* Quality Function Deployment
Qualifications only selection method, 473
Qualitative risk analysis. *See* Perform Qualitative Risk Analysis process
Quality. *See also* Plan Quality Management process; Project Quality Management definition, 718 grade and, 274
Quality assurance, 289. *See also* Manage Quality process
Quality audits, 290, 294–296, 718
Quality checklists, 292, 718
Quality control measurements definition, 718 as input, 124, 291 as output, 305
Quality function deployment, 145
Quality improvement initiatives, 275 methods, 296
Quality management. *See* Project Quality Management
Quality management plan, 87, 320. *See also* Manage Quality process; Plan Quality Management process; Project Quality Management definition, 718 as input, 135, 241, 314, 411, 469 as output, 286, 297, 447, 490
Quality management system, 718
Quality metrics definition, 718 as input, 291, 300 as output, 287
Quality policy, 718
Quality report, 108, 124, 165, 296, 382, 495, 718
Quality requirements, 148, 718
Quality standards. *See* Standard
Quantitative risk analysis. *See* Perform Quantitative Risk Analysis process
Questionnaires, 143, 303, 511, 718
Quotation, 477

R

RACI. *See* Responsible, accountable, consult and inform (RACI) chart
RACI chart, 317, 718
RAM. *See* Assignment matrix; Responsibility assignment matrix
RBS. *See* Resource breakdown structure; Risk breakdown structure
RCA. *See* Root cause analysis
Recognition, 319, 341–342
Regression analysis, 126, 718
Regulations, 718
Regulatory bodies, 550
Report(s). *See also* Quality report; Risk report final, 127–128 project, 123, 361, 362, 388 work performance, 26
Reporting formats, 182, 239, 408, 455, 525
Requested change. *See also* Change requests
Request for information (RFI), 477, 718
Request for proposal (RFP), 477, 718
Request for quotation (RFQ), 477, 719
Requirement(s). *See also* High-level requirements; Product requirements business, 148 classifications, 148 cross-functional, 145 definition, 719 functional, 118, 148 legal, 78, 369, 370 nonfunctional, 148 organizational communication, 369, 383, 391, 520, 525, 533 project, 148 quality, 148, 718 solution, 148 stakeholder, 148 transition and readiness, 148
Requirements documentation, 147–148. *See also* Collect Requirements process; Contract(s) definition, 719 as input, 124, 152, 157, 165, 169, 280, 314, 368, 412, 470, 485, 495, 510 as output, 97, 147–148, 155, 162, 167, 171, 480, 491

Requirements Management: A Practice Guide, 132

Requirements management plan, 87, 137, 140, 165, 169, 279, 719
 as input, 411, 484, 495
 as output, 490

Requirements traceability matrix
 definition, 719
 example of, 149
 as input, 93, 116, 165, 169, 280, 470, 496
 as output, 148–149, 155, 167, 171, 287, 480, 491, 501

Reserve, 719. *See also* Management reserve

Reserve analysis, 202, 245, 265, 456, 719. *See also*
 Contingency reserve

Residual risk, 448, 719

Resolution of conflicts. *See* Conflict management

Resource(s)
 availability of, 178
 definition, 719
 industry-specific, 311
 number of, 197

Resource assignments. *See* Physical resource assignments

Resource breakdown structure (RBS)
 data representation and, 316
 definition, 719
 as input, 101, 198, 355
 as output, 326, 335, 358
 sample, 327

Resource calendars
 definition, 719
 as input, 199, 208, 225, 323, 331, 339, 440
 as output, 230, 334, 344, 491

Resource histogram, 719

Resource leveling, 207, 211, 212, 719

Resource management plan, 87, 250, 318, 322
 definition, 719
 as input, 368, 381, 390, 411, 439, 469, 518, 532
 as output, 334, 351, 358, 447, 535

Resource manager, 719

Resource optimization techniques, 211–212, 227, 719

Resource planning, 217, 313, 314

Resource requirements. *See also* Project Resource Management
 definition, 720
 as input, 208, 242, 331, 355, 413, 431, 470
 as output, 221, 325, 500

Resource smoothing, 211, 720

Responsibility, 319, 720

Responsibility assignment matrix (RAM), 720

Responsible, accountable, consult, and inform (RACI)
 chart, 317, 718

Result(s). *See also* Deliverable(s)
 definition, 720
 final, 127
 projects and, 4

Retrospectives, 224, 276, 305, 535. *See also* Lessons learned

Return on investment (ROI), 15, 473

Reviews
 approved change requests, 305
 design, 233
 documentation, 705
 peer, 303
 performance, 227, 303, 356, 498, 712
 product, 165
 project, 364
 risk, 721

Rewards, 319, 341–342

Rework, 10, 720

RFI. *See* Request for information

RFP. *See* Request for proposal

RFQ. *See* Request for quotation

Risk(s). *See also* Identified risks; Identify Risks process; Monitor Risks process; Opportunities; Project Risk Management; Project risk(s); Threat(s)
 definition, 720
 levels of, 397
 negative, 395, 397
 overall project, 712
 positive, 395, 397
 project life cycle and, 549
 residual, 719
 secondary, 722

Risk acceptance
 active/passive strategies, 443, 444, 446
 definition, 720

Risk analysis. *See* Perform Qualitative Risk Analysis process; Perform Quantitative Risk Analysis process

Risk appetite, 720

Risk attitudes, 420, 518

Risk audits, 456, 458, 720

Risk avoidance, 443, 720

Risk breakdown structure (RBS)
 definition, 720
 extract from sample, 406
 risk categories and, 405

Risk categorization, 425, 720

Risk category, 405, 417, 720

Risk data quality assessment, 423, 720

Risk enhancement, 720

Risk escalation, 545, 720

Risk exploiting, 721

Risk exposure, 398. *See also* Plan Risk Responses process;

Risk report
 assessment of overall project, 436
 definition, 721

Risk identification. *See* Identify Risks process

Risk impact. *See* Probability and impact matrix

Risk management plan, 87, 405. *See also* Plan Risk Management process
 definition, 721
 elements of, 405–408
 as input, 236, 279, 412, 430, 439, 484, 495, 518, 525
 as output, 287, 405–408, 490, 500

Risk mitigation, 443, 446, 721

Risk owner, 721

Risk parameters, assessment of other, 423–424

Risk perception, 420

Risk probability and impacts
 assessment, 423
 description, 407
 matrix/scoring scheme, 408

Risk register, 97
 content of, 417
 definition, 721
 as input, 93, 125, 152, 199, 208, 242, 250, 280, 291, 314, 323, 355, 421, 431, 440, 450, 455, 470, 485, 496, 519, 532
 as output, 113, 221, 230, 247, 256, 270, 287, 297, 306, 320, 335, 358, 387, 417, 427, 448, 452, 458, 480, 491, 501, 515, 536

Risk report
 definition, 721
 as input, 93, 116, 125, 291, 382, 431, 440, 450, 455
 as output, 418, 427, 448, 452, 458

Risk responses, 436. *See also* Plan Risk Responses process

Risk reviews, 721

Risk sharing, 444, 721

Risk threshold
 agreed-upon, 398, 445
 definition, 721
 measurable, 398, 407
 setting, 403

Risk transference, 443, 445, 721

Risk triggers, 417, 448

Role(s)
 definition, 721
 project manager and, 51
 responsibilities and, 318

Role-responsibility-authority forms, 317

Rolling wave planning, 160, 185, 721

Root cause analysis (RCA), 111, 292, 303, 415, 521, 533, 721

S

Safety, 24, 45, 315
 Design for X and, 295
 enterprise environmental factors and, 78, 84, 117
 requirements documentation and, 470, 480, 485, 491, 495
 solution requirements and, 148
 stakeholder analysis and, 512

Scatter diagrams, 293, 304

Schedule(s), 721. *See also* Control Schedule process; Master schedule; Project schedule; Schedule model

Schedule baseline, 87. *See also* Baseline schedule
 definition, 721
 as input, 116, 224, 412, 430, 495
 as output, 171, 186, 217, 229, 297, 351, 358, 447, 490, 500

Schedule compression, 228, 721

Schedule compression techniques, 215

Schedule control. *See* Control Schedule process

Schedule data, 721

- as input, 225
- as output, 220, 230

Schedule development. *See* Develop Schedule process

Schedule-drivers, 464

Schedule forecasts

- definition, 722
- as input, 108, 431
- as output, 113, 228

Schedule management plan, 87, 181. *See also* Develop

Schedule process

- definition, 722
- as input, 184, 188, 198, 207, 224, 236, 411
- as output, 181–182, 229, 447

Schedule model, 722

Schedule network analysis, 209, 722. *See also* Backward pass; Critical path method; Resource leveling

Schedule performance index (SPI), 182, 226, 233, 263, 722

Schedule variance (SV), 262, 722

Scheduling

- alternative, with a backlog, 177
- on-demand, 177
- overview, 176

Scheduling, Practice Standard for, 175, 178, 207, 214

Scheduling software, 38, 95, 216, 227, 357

Scheduling tool, 722

Scope, 722. *See also* Product scope; Project scope

Scope baseline. *See also* Control Scope process

- definition, 722
- elements of, 242
- as input, 116, 165, 169, 184, 188, 198, 207, 224, 242, 250, 279, 314, 322, 412, 430, 469
- as output, 161–162, 171, 287, 297, 447, 490

Scope change, 304, 319, 402, 472

Scope creep, 154, 168, 182, 722

Scope exclusions, 154

Scope management plan, 87, 137

- definition, 722
- as input, 140, 165, 169, 180, 469, 484
- as output, 137, 171

- scope of work and, 469, 484

Scope model. *See* Context diagrams

Scope of work

- activity list and, 185
- firm fixed price (FFP) and, 471
- scope management plan and, 469, 484
- WBS and, 157, 161

Scope statement. *See* Project scope statement

Secondary risks, 448, 722

Selected sellers, 488

Self-organizing teams, 310, 722

Seller(s). *See also* Buyer-seller relationship; Project Procurement Management

- buyer and, 460–461
- definition, 722
- partnership with, 275
- prequalified, 501
- terms for, 461

Seller lists

- preapproved, 471
- prequalified, 501

Seller performance evaluation documentation, 501

Seller proposals

- definition, 722
- as input, 486

Sender-receiver communication models, 371, 381

Sensitivity analysis, 434, 722

Sequence Activities process, 187–194, 573

- definition, 723
- inputs, 188–189
- outputs, 194
- overview, 187–188
- tools and techniques, 189–193

Sequencing, 188

Service(s)

- final, 127
- projects and, 4

Service level agreements (SLAs), 78, 461, 723

SF. *See* Start-to-finish

Shared portal, 340

Sharing, opportunity and, 444

Shewhart, Walter A., 275

Simulation, 213–214, 433–434, 723

SIPOC model, 284, 285

Situation, analysis of, 31
 Six Sigma, 275
 Skills. *See also* Interpersonal skills; Team skills
 communication, 363, 384, 534
 influencing, 341, 350, 357
 leadership, 60–63
 management, 710
 networking, 386, 534, 711
 PMI Talent Triangle® and, 56–57
 project manager and, 52
 soft, 53, 357
 strategic and business management, 58–60
 technical project management, 58
 Slack. *See* Float
 SLAs. *See* Service level agreements
 SMEs. *See* Subject matter experts
 Social computing, 364, 374
 Social media management, 385
 Soft skills, 53, 357
 Software. *See also* Scheduling software
 information technology, 38
 project management, 188, 194, 377, 385
 simulation and, 433
 WBS structure and, 159
 Software development, 84, 252
 JAD sessions and, 145
 storyboards and, 147
 Solution requirements, 148
 Source selection criteria, 473–474, 478–479, 485, 723
 SOW. *See* Statement of work
 Specification, 723
 Specification limits, 723. *See also* Control limits
 Sphere of influence, project manager, 52–56
 SPI. *See* Schedule performance index
 Sponsor, 29, 723
 Sponsoring organization, 33, 723
 SS. *See* Start-to-start
 Staffing management plan. *See* Project Resource Management
 Stage gate, 21, 545
 Stakeholder(s). *See also* Identify Stakeholders process; Management Stakeholder Engagement process; Project stakeholder(s)
 classification of, 514
 definition, 723
 external, 550
 good practices and, 2
 internal, 550
 key, 34, 80, 145, 298, 407, 454, 624
 project meetings and, 364
 project reviews and, 364
 project success and, 34
 tailoring considerations, 365
 unsatisfied, 10
 Stakeholder analysis, 512, 533, 723
 Stakeholder engagement assessment matrix, 521–522, 723
 Stakeholder engagement plan, 87, 140, 279, 522
 definition, 723
 as input, 368, 381, 390, 509, 525, 532
 as output, 387, 393, 522, 529, 535
 Stakeholder expectation, 363
 Stakeholder identification, 367, 504, 510, 514, 532
 Stakeholder register
 definition, 723
 as input, 141, 280, 314, 331, 368, 382, 413, 421, 440, 470, 485, 496, 519, 525, 532
 as output, 155, 287, 335, 378, 514, 387, 393, 480, 491, 501, 529, 536
 Stakeholder relations
 complexity of, 506
 technology and, 464
 Stakeholder requirements, 148
Standard for Portfolio Management, The, 3, 33
Standard for Program Management, The, 3, 14, 33
Standard for Project Management, The, 2–3, 28
 overview, 541
 Standup meetings, 95, 364, 535
 Start date, 723
 Start-to-finish (SF), 190, 723
 Start-to-start (SS), 190, 724
 Statement of work (SOW), 462, 468, 469
 definition, 724
 procurement, 477–478, 485
 Statistical sampling, 303, 724
 Storyboarding, 147

Strategic management, PMI Talent Triangle® and, 56, 57
 Strategic opportunity/business need, 546
 Strategic planning, 185. *See also* Organizational strategy
 Strategic project management skills, 58–60
 Strategic skills, 58–60
 Strengths, weaknesses, opportunities and threats. *See* SWOT analysis
 Subcontractors, 38, 462
 Subject matter experts (SMEs), 54, 55, 104. *See also* Expert judgment
 brainstorming and, 80, 85, 281
 facilitation and, 145
 interviews and, 142, 282, 414
 Subsidiary management plans, 87, 558
 Subsidiary plans, 83, 135, 316, 479, 489, 499
 Success
 factors, critical, 31
 project, measurement of, 34–35
 Successor activity, 186, 188, 190, 214
 definition, 189, 724
 lags and, 193
 leads and, 192
 multiple, 194
 Summary activity, 194, 217, 724
 Supplier. *See* Seller(s)
 Surveys, 143, 303, 511, 718
 SV. *See* Schedule variance
 SWOT analysis, 415, 724
 System(s). *See* Organizational systems
 Project Risk Management and, 400
 Project Schedule Management and, 178
 Project Scope Management and, 133
 Project Stakeholder Engagement and, 506
 Talent, 56–57
 TCPI. *See* To-complete performance index
 Team(s). *See also* Colocated teams; Develop Project Team process; Project management team; Project team(s)
 acquisition of members, 311
 high-performance, 346
 management of, 311
 project manager and, 51
 self-organizing, 310, 722
 virtual, 311, 333, 340, 725
 Team assessments, 342
 Team building, 341
 Team-building activities, 337, 341, 342
 Team charter, 319–320, 339, 347, 724
 Team management plan, 724
 Team performance assessments, 339, 343, 347
 Team skills, 144–145
 definition, 708
 interpersonal skills and, 332–333, 341, 348–350, 357, 375–376, 386, 392, 416, 432, 442, 451, 488, 527, 534
 risk and, 424
 types of, 80, 104
 Technical performance analysis, 456
 Technical project management skills, 58
 PMI Talent Triangle® and, 56, 57
 Technique(s)
 definition, 724
 information management, 103–104
 knowledge management, 103
 project management processes and, 22
 Technology. *See also* Communication technologies; E-mail; Software; Web conferencing
 advances in, 78, 197
 availability/reliability of, 370
 communications, 365
 stakeholder relations and, 464
 support, 178
 Templates, 40, 724
 Terms of reference (TOR), 468, 469, 478

T

T&M. *See* Time and Material Contract

Tacit knowledge, 724

Tailoring, 2

 definition, 724

 overview, 28

 project artifacts, 558–559

 Project Communications Management and, 365

 Project Cost Management and, 234

 Project Integration Management and, 74

 Project Procurement Management and, 465

 Project Quality Management and, 276

 Project Resource Management and, 311

- Test and evaluation documents, 296, 300, 303–304, 306, 724
 - Test and inspection planning, 285
 - Text-oriented formats, roles and responsibilities, 317
 - Theory of Constraints (TOC), 310
 - Threat(s), 397
 - definition, 724
 - strategies for, 442–443
 - Three-point estimate, 201, 244–245, 724
 - Threshold, 724
 - Time and Material Contract (T&M), 472, 724
 - Time-boxing, 182
 - Time management. *See* Project Schedule Management
 - Time-phased project budget, 87, 248, 254
 - Time-scaled schedule network diagram, 218
 - TOC. *See* Theory of Constraints
 - To-complete performance index (TCPI), 266, 268, 724
 - Tolerances, 274, 725
 - Tools
 - advances in, 463
 - automated, 73
 - change control, 118–119, 700
 - definition, 725
 - information management, 103–104
 - knowledge management, 103
 - project management processes and, 22
 - visual management, 73
 - TOR. *See* Terms of reference
 - Tornado diagram, 434, 436, 725
 - Total float, 191, 210, 725
 - Traceability matrices, 40
 - Transfer. *See* Risk transference
 - Trend(s)
 - industry specific, 55
 - Project Communications Management and, 364
 - Project Cost Management, 233
 - Project Integration Management and, 73
 - Project Procurement Management and, 463–464
 - Project Quality Management and, 275
 - Project Resource Management and, 310–311
 - Project Risk Management and, 398–399
 - Project Schedule Management, 177
 - Project Scope Management and, 132
 - Project Stakeholder Engagement and, 505
 - quantitative risk analysis and, 436
 - Trend analysis, 111, 126, 170, 227, 263–265, 356, 498, 725
 - Triangular distribution, 201, 245
 - Trigger condition, 448, 518, 725
 - Tuckman ladder of team development, 338
- ## U
- Unanimity, 144, 725
 - Uncertainty, 398, 415
 - Union labor/contracts. *See* Contracts
 - Units of measure, 182, 238
 - “Unknown-unknowns,” 202
 - Update(s)
 - change request for, 96
 - definition, 725
 - User stories, 145
- ## V
- VAC. *See* Variance at completion
 - Validate Scope process, 131, 163–167, 618–619
 - definition, 725
 - inputs, 165
 - outputs, 166–167
 - overview, 163–164
 - tools and techniques, 166
 - Validation
 - control and, 133
 - definition, 725
 - Value. *See* Business value
 - Value analysis. *See* Earned value analysis (EVA)
 - Variance, 725
 - Variance analysis, 111, 126, 170, 262–263, 725
 - Variance at completion (VAC), 725
 - Variation, 725
 - Vendor. *See* Seller(s)
 - Vendor conferences. *See* Bidder conferences
 - Verification, 725
 - Verified deliverables, 165, 305, 725
 - Video conferencing, 340
 - Virtual meetings, 103, 392

Virtual teams, 311, 333, 340, 725
Visual management tools, 73
VOC. *See* Voice of the Customer
Voice of the Customer (VOC), 145, 726
Voting, 111, 119, 144, 534

W

Walkthroughs, 166, 224, 303, 498
Watch list, risks and, 423, 427, 440, 455
Waterfall development approach, 135, 185
Waterfall life cycles, 19
Waterfall model-based projects, 299, 400
WBS. *See* Work breakdown structure
WBS dictionary, 162, 726
WBS ID, 186
What-if scenario analysis, 213, 227, 726
Work breakdown structure (WBS). *See also* Create WBS
process
approaches to, 159
cost management plan and, 239
data representation and, 316
definition, 726
as output, 161
planned value and, 261
planning package and, 161
samples, 159–160
scope baseline and, 242
WBS ID, 186
Work breakdown structure component, 726
Work Breakdown Structures, Practice Standard for –
Second Edition, 161
Work packages, 157
decomposition and, 158, 183, 185
definition, 726
description of, 161
level of detail and, 158
progressive elaboration and, 186
Work performance data, 26
definition, 726
as input, 165, 169, 225, 260, 301, 355, 390, 456,
496, 532
as output, 95

Work performance information, 26, 357
definition, 726
as input, 109, 535
as output, 166, 170, 228, 305, 392, 457, 499
Work performance reports, 26
definition, 726
as input, 116, 347, 382, 456
as output
Workshops, 145. *See also* Facilitated workshops
Written communication, 360, 361. *See also* E-mail 5 Cs of,
361, 362–363

X

X, Design for X (DfX), 295

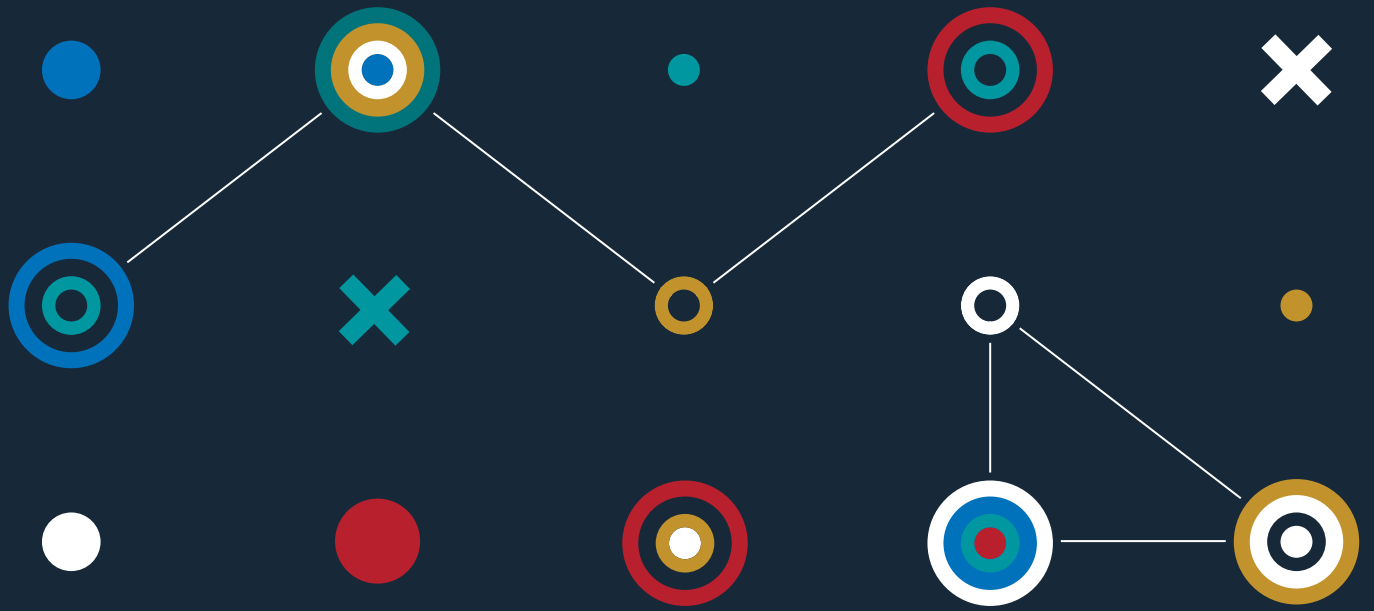

AGILE

PRACTICE GUIDE

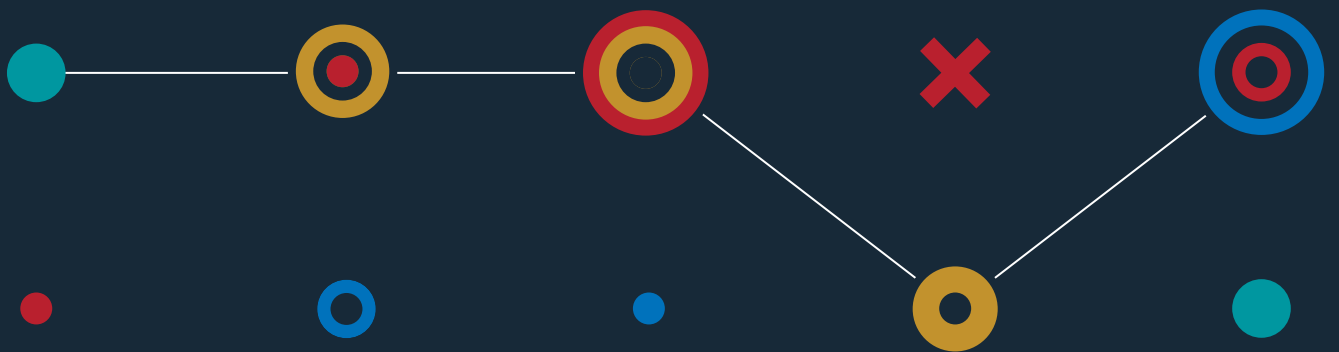

AGILE PRACTICE GUIDE



Library of Congress Cataloging-in-Publication Data has been applied for.

ISBN: 978-1-62825-199-9

Published by:

Project Management Institute, Inc.
14 Campus Boulevard
Newtown Square, Pennsylvania 19073-3299 USA
Phone: +1 610-356-4600
Fax: +1 610-356-4647
Email: customer-care@pmi.org
Internet: www.PMI.org

©2017 Project Management Institute, Inc. All rights reserved.

Project Management Institute, Inc. content is copyright protected by U.S. intellectual property law that is recognized by most countries. To republish or reproduce PMI's content, you must obtain our permission. Please go to <http://www.pmi.org/permissions> for details.

To place a Trade Order or for pricing information, please contact Independent Publishers Group:

Independent Publishers Group
Order Department
814 North Franklin Street
Chicago, IL 60610 USA
Phone: +1 800-888-4741
Fax: +1 312- 337-5985
Email: orders@ipgbook.com (For orders only)

For all other inquiries, please contact the PMI Book Service Center.

PMI Book Service Center
P.O. Box 932683, Atlanta, GA 31193-2683 USA
Phone: 1-866-276-4764 (within the U.S. or Canada) or +1-770-280-4129 (globally)
Fax: +1-770-280-4113
Email: info@bookorders.pmi.org

Printed in the United States of America. No part of this work may be reproduced or transmitted in any form or by any means, electronic, manual, photocopying, recording, or by any information storage and retrieval system, without prior written permission of the publisher.

The paper used in this book complies with the Permanent Paper Standard issued by the National Information Standards Organization (Z39.48—1984).

PMI, the PMI logo, PMBOK, OPM3, PMP, CAPM, PgMP, PfMP, PMI-RMP, PMI-SP, PMI-ACP, PMI-PBA, PROJECT MANAGEMENT JOURNAL, PM NETWORK, PMI TODAY, PULSE OF THE PROFESSION and the slogan MAKING PROJECT MANAGEMENT INDISPENSABLE FOR BUSINESS RESULTS. are all marks of Project Management Institute, Inc. For a comprehensive list of PMI trademarks, contact the PMI Legal Department. All other trademarks, service marks, trade names, trade dress, product names and logos appearing herein are the property of their respective owners. Any rights not expressly granted herein are reserved.

SAFe is a registered mark of Scaled Agile, Inc.

Agile Alliance and the Agile Alliance logo are marks of Agile Alliance.

This Practice Guide was jointly funded by Agile Alliance® and was developed in collaboration with members of the Agile Alliance®. Agile Alliance® does not endorse any agile methodology or certification.

10 9 8 7 6 5 4 3 2 1

NOTICE

The Project Management Institute, Inc. (PMI) standards and guideline publications, of which the document contained herein is one, are developed through a voluntary consensus standards development process. This process brings together volunteers and/or seeks out the views of persons who have an interest in the topic covered by this publication. While PMI administers the process and establishes rules to promote fairness in the development of consensus, it does not write the document and it does not independently test, evaluate, or verify the accuracy or completeness of any information or the soundness of any judgments contained in its standards and guideline publications.

PMI disclaims liability for any personal injury, property or other damages of any nature whatsoever, whether special, indirect, consequential or compensatory, directly or indirectly resulting from the publication, use of application, or reliance on this document. PMI disclaims and makes no guaranty or warranty, expressed or implied, as to the accuracy or completeness of any information published herein, and disclaims and makes no warranty that the information in this document will fulfill any of your particular purposes or needs. PMI does not undertake to guarantee the performance of any individual manufacturer or seller's products or services by virtue of this standard or guide.

In publishing and making this document available, PMI is not undertaking to render professional or other services for or on behalf of any person or entity, nor is PMI undertaking to perform any duty owed by any person or entity to someone else. Anyone using this document should rely on his or her own independent judgment or, as appropriate, seek the advice of a competent professional in determining the exercise of reasonable care in any given circumstances. Information and other standards on the topic covered by this publication may be available from other sources, which the user may wish to consult for additional views or information not covered by this publication.

PMI has no power, nor does it undertake to police or enforce compliance with the contents of this document. PMI does not certify, test, or inspect products, designs, or installations for safety or health purposes. Any certification or other statement of compliance with any health or safety-related information in this document shall not be attributable to PMI and is solely the responsibility of the certifier or maker of the statement.

PREFACE

The Project Management Institute and Agile Alliance® chartered this practice guide to create a greater understanding of agile approaches in their communities. The vision for this practice guide is to equip project teams with tools, situational guidelines, and an understanding of the available agile techniques and approaches to enable better results.

Project teams are using agile approaches in a variety of industries beyond software development. Both organizations realize that expansion has created a need for a common language, open mindedness, and the willingness to be flexible in how products and deliverables are brought to market. In addition, both organizations realize there are multiple ways to achieve successful delivery. There are a broad range of tools, techniques, and frameworks; teams have choices for approaches and practices that fit their project and the organizational culture in order to achieve the desired outcome.

The *Agile Practice Guide* core committee members are from varying backgrounds and use various approaches. Some of the committee members are consultants and some work inside organizations. All have worked in agile ways for many years.

TABLE OF CONTENTS

- 1. INTRODUCTION..... 1**
- 2. AN INTRODUCTION TO AGILE 7**
 - 2.1 Definable Work vs. High-Uncertainty Work..... 7**
 - 2.2 The Agile Manifesto and Mindset 8**
 - 2.3 Lean and the Kanban Method 12**
 - 2.4 Uncertainty, Risk, and Life Cycle Selection..... 13**
- 3. LIFE CYCLE SELECTION 17**
 - 3.1 Characteristics of Project Life Cycles..... 18**
 - 3.1.1 Characteristics of Predictive Life Cycles..... 20**
 - 3.1.2 Characteristics of Iterative Life Cycles 21**
 - 3.1.3 Characteristics of Incremental Life Cycles 22**
 - 3.1.4 Characteristics of Agile Life Cycles..... 24**
 - 3.1.5 Agile Suitability Filters..... 25**
 - 3.1.6 Characteristics of Hybrid Life Cycles 26**
 - 3.1.7 Combined Agile and Predictive Approaches 27**
 - 3.1.8 Predominantly Predictive Approach with Some Agile Components 28**
 - 3.1.9 A Largely Agile Approach with a Predictive Component..... 28**
 - 3.1.10 Hybrid Life Cycles as Fit-For-Purpose..... 29**
 - 3.1.11 Hybrid Life Cycles as Transition Strategy 30**
 - 3.2 Mixing Agile Approaches 31**
 - 3.3 Project Factors That Influence Tailoring 32**

4. IMPLEMENTING AGILE: CREATING AN AGILE ENVIRONMENT	33
4.1 Start with an Agile Mindset.....	33
4.2 Servant Leadership Empowers the Team.....	33
4.2.1 Servant Leader Responsibilities	34
4.2.2 Role of the Project Manager in an Agile Environment.....	37
4.2.3 Project Managers Use Servant Leadership	38
4.3 Team Composition.....	38
4.3.1 Agile Teams	39
4.3.2 Agile Roles.....	40
4.3.3 Generalizing Specialists.....	42
4.3.4 Team Structures.....	43
4.3.5 Dedicated Team Members	44
4.3.6 Team Workspaces.....	46
4.3.7 Overcoming Organizational Silos	47
5. IMPLEMENTING AGILE: DELIVERING IN AN AGILE ENVIRONMENT.....	49
5.1 Charter the Project and the Team.....	49
5.2 Common Agile Practices	50
5.2.1 Retrospectives.....	50
5.2.2 Backlog Preparation	52
5.2.3 Backlog Refinement.....	52
5.2.4 Daily Standups	53
5.2.5 Demonstrations/Reviews.....	55
5.2.6 Planning for Iteration-Based Agile	55
5.2.7 Execution Practices that Help Teams Deliver Value	56
5.2.8 How Iterations and Increments Help Deliver Working Product.....	57
5.3 Troubleshooting Agile Project Challenges	57
5.4 Measurements in Agile Projects	60
5.4.1 Agile Teams Measure Results	61

6. ORGANIZATIONAL CONSIDERATIONS FOR PROJECT AGILITY	71
6.1 Organizational Change Management	71
6.1.1 Drivers for Change Management.....	73
6.1.2 Readiness for Change	73
6.2 Organizational Culture.....	75
6.2.1 Creating an Environment of Safety.....	75
6.2.2 Assessing Culture	75
6.3 Procurement and Contracts	77
6.4 Business Practices	79
6.5 Multiteam Coordination and Dependencies (Scaling).....	80
6.5.1 Frameworks.....	80
6.5.2 Considerations	80
6.6 Agile and the Project Management Office (PMO).....	81
6.6.1 An Agile PMO is Value-Driven.....	81
6.6.2 An Agile PMO is Invitation-Oriented	81
6.6.3 An Agile PMO is Multidisciplinary	82
6.7 Organizational Structure	83
6.8 Evolving the Organization	84
7. A CALL TO ACTION	87
ANNEX A1	
<i>PMBOK®</i> GUIDE MAPPING	89
ANNEX A2	
AGILE MANIFESTO MAPPING	97
ANNEX A3	
OVERVIEW OF AGILE AND LEAN FRAMEWORKS.....	99
APPENDIX X1	
CONTRIBUTORS AND REVIEWERS.....	115

APPENDIX X2	
ATTRIBUTES THAT INFLUENCE TAILORING.....	119
APPENDIX X3	
AGILE SUITABILITY FILTER TOOLS.....	125
REFERENCES	139
BIBLIOGRAPHY	141
GLOSSARY	149
INDEX	157



LIST OF TABLES AND FIGURES

Figure 2-1.	The Four Values of the Agile Manifesto	8
Figure 2-2.	The Twelve Principles Behind the Agile Manifesto	9
Figure 2-3.	The Relationship Between the Agile Manifesto Values, Principles, and Common Practices	10
Figure 2-4.	Agile is a Blanket Term for Many Approaches	11
Figure 2-5.	Uncertainty and Complexity Model Inspired by the Stacey Complexity Model	14
Figure 3-1.	The Continuum of Life Cycles	19
Figure 3-2.	Predictive Life Cycle	21
Figure 3-3.	Iterative Life Cycle	21
Figure 3-4.	A Life Cycle of Varying-Sized Increments	22
Figure 3-5.	Iteration-Based and Flow-Based Agile Life Cycles	24
Figure 3-6.	Agile Development Followed by a Predictive Rollout	27
Figure 3-7.	A Combined Agile and Predictive Approach Used Simultaneously	27
Figure 3-8.	A Largely Predictive Approach with Agile Components	28
Figure 3-9.	A Largely Agile Approach with a Predictive Component	28
Figure 5-1.	Burndown Chart for Remaining Story Points	62
Figure 5-2.	Burnup Chart for Showing Story Points Completed	63
Figure 5-3.	Example of a Kanban Board	65
Figure 5-4.	Feature Chart	67
Figure 5-5.	Product Backlog Burnup Chart	68

Figure 5-6.	Earned Value in an Agile Context.....	69
Figure 5-7.	Cumulative Flow Diagram of Completed Features.....	70
Figure 6-1.	The Relationship Between Change Management and Agile Approaches	72
Figure 6-2.	Example of Assessing Organizational Culture	76
Figure 6-3.	Initial Ranked Backlog for Changes	85
Figure 6-4.	Using Backlogs and Kanban Boards to Organize and Track Change Work	86
Figure A3-1.	Agile Approaches Plotted by Breadth and Detail	100
Figure A3-2.	Kanban Board Demonstrating Work in Progress Limits, and a Pull System to Optimize the Flow of Work	105
Figure A3-3.	The Crystal Family of Methods.....	106
Figure A3-4.	Feature-Driven Development Project Life Cycle.....	109
Figure A3-5.	DSDM Approach to Constraint-Driven Agility.....	110
Figure A3-6.	Representatives of Scrum Teams Participating in SoS teams	112
Figure X3-1.	Model for Suitability of Agile Approach.....	127
Figure X3-2.	Buy-In to Approach Assessment	129
Figure X3-3.	Trust in Team Assessment.....	130
Figure X3-4.	Assessment for Decision-Making Powers of Team	130
Figure X3-5.	Team Size Assessment.....	131
Figure X3-6.	Experience Level Assessment.....	131
Figure X3-7.	Assessment for Access to the Customer/Business	132
Figure X3-8.	Likelihood of Change Assessment.....	132
Figure X3-9.	Assessment for Criticality of Product or Service	133
Figure X3-10.	Incremental Delivery Assessment	133
Figure X3-11.	Suitability Assessment Radar Chart.....	134
Figure X3-12.	Drug Store Project	135
Figure X3-13.	Military Messaging Example.....	137

Table 1-1.	In-Scope and Out-of-Scope Items	4
Table 3-1.	Characteristics of Four Categories of Life Cycles	18
Table 3-2.	Tailoring Options to Improve Fit.....	32
Table 4-1.	Attributes of Successful Agile Teams.....	40
Table 4-2.	Agile Team Roles	41
Table 5-1.	Agile Pain Points and Troubleshooting Possibilities.....	58
Table A1-1.	Project Management Process Group and Knowledge Area Mapping.....	90
Table A1-2.	Application of Agile in <i>PMBOK® Guide</i> Knowledge Areas.....	91
Table A2-1.	Agile Manifesto Values Covered in the <i>Agile Practice Guide</i>	97
Table A2-2.	<i>Agile Practice Guide</i> Mapping of Principles Behind the Agile Manifesto.....	98
Table A3-1.	Scrum Events and Artifacts.....	101
Table A3-2.	The Practices of eXtreme Programming.....	102
Table A3-3.	Defining Principles and Properties of the Kanban Method.....	104
Table A3-4.	The Core Values and Common Properties of Crystal	107
Table A3-5.	The Key Elements of the Agile Unified Process	111
Table A3-6.	Comparison of LeSS and Scrum	113
Table X2-1.	Tailoring Guidelines.....	121





1

INTRODUCTION

Welcome to the *Agile Practice Guide*! This guide was developed as a collaborative effort by the Project Management Institute (PMI) and Agile Alliance®. The members of the core writing team who developed this practice guide included volunteers from both organizations, drawing on subject matter expertise from a broad range of current practitioners and leaders from a diverse range of backgrounds, beliefs, and cultures.

This practice guide provides practical guidance geared toward project leaders and team members adapting to an agile approach in planning and executing projects. While our core writing team recognizes there is staunch support to use predictive approaches and conversely, passion around shifting to an agile mindset, values, and principles, this practice guide covers a practical approach to project agility. This practice guide represents a bridge to understanding the pathway from a predictive approach to an agile approach. In fact, there are similar activities between the two, such as planning, that are handled differently but occur in both environments.

Our core writing team used an agile mindset to collaborate and manage the development of this first edition of the practice guide. As technology and culture changes, future updates and refinements to the practice guide will reflect current approaches.

Our core team adopted a more informal, relaxed writing style for this practice guide than is typical for PMI standards. The guide incorporates new elements, such as tips, sidebars, and case studies to better illustrate key points and concepts. Our team intends for these changes to make this practice guide more readable and user-friendly.

This practice guide goes beyond addressing the use of agile in the computer software development industry, because agile has expanded into non-software development environments. Manufacturing, education, healthcare and other industries are becoming agile to varying degrees and this use beyond software is within the scope of this practice guide.



AGILE-BASED LEARNING

Education is a prime and fertile ground to expand agile practices beyond software development. Teachers in middle schools, high schools, and universities around the world are beginning to use agile to create a culture of learning. Agile techniques are used to provide focus on prioritizing competing priorities. Face-to-face interaction, meaningful learning, self-organizing teams, and incremental and/or iterative learning that exploit the imagination are all agile principles that can change the mindset in the classroom and advance educational goals (Briggs, 2014).*

*Briggs, Sara. "Agile Based Learning: What Is It and How Can It Change Education?" *Opencolleges.edu.au* February 22, 2014, retrieved from <http://www.opencolleges.edu.au/informed/features/agile-based-learning-what-is-it-and-how-can-it-change-education/>

So why an *Agile Practice Guide* and why now? Project teams have used agile techniques and approaches in various forms for at least several decades. The Agile Manifesto [1]¹ expressed definitive values and principles of agile as the use of agile gained substantial momentum (see Section 2.1). Today, project leaders and teams find themselves in an environment disrupted by exponential advances in technology and demands from customers for more immediate delivery of value. Agile techniques and approaches effectively manage disruptive technologies. In addition, the first principle of agile places customer satisfaction as the highest priority and is key in delivering products and services that delight customers (see Section 2.1). Rapid and transparent customer feedback loops are readily available with the widespread use of social media. Therefore, in order to stay competitive and relevant, organizations can no longer be internally focused but rather need to focus outwardly to the customer experience.

¹ The numbers in brackets refer to the list of references at the end of this practice guide.

Disruptive technologies are rapidly changing the playing field by decreasing the barriers to entry. More mature organizations are increasingly prone to being highly complex and potentially slow to innovate, and lag behind in delivering new solutions to their customers. These organizations find themselves competing with smaller organizations and startups that are able to rapidly produce products that fit customer needs. This speed of change will continue to drive large organizations to adopt an agile mindset in order to stay competitive and keep their existing market share.

The *Agile Practice Guide* is project-focused and addresses project life cycle selection, implementing agile, and organizational considerations for agile projects. Organizational change management (OCM) is essential for implementing or transforming practices but, since OCM is a discipline within itself, it is outside the scope of this practice guide. Those seeking guidance in OCM may refer to *Managing Change in Organizations—A Practice Guide* [2].

Additional items that are in scope and out of scope for this practice guide are listed in Table 1-1.

DISRUPTIVE TECHNOLOGY

Disruptive technology is especially enabled by the transition to cloud computing. Companies across the globe are leveraging the model for quick and cheap access to computing resources and to gain entry into traditional markets. Cloud computing requires a reduced upfront payment, but is paid over time via a subscription service, based upon a pay-as-you-go or pay-what-you-use model. Updated applications, infrastructure, and platforms are released into the cloud in an iterative and incremental fashion, keeping pace with improvements to technology and evolving customer demand.



Table 1-1. In-Scope and Out-of-Scope Items

In Scope	Out of Scope
Implementing agile approaches at a project or team level	Implementing agile throughout the organization or creating agile programs
Coverage of most popular agile approaches, as listed in industry surveys	Coverage of niche approaches, company-specific methods, or incomplete life cycle techniques
Suitability factors to consider when choosing an agile approach and/or practice	Recommending or endorsing a particular approach/practice
Mapping agile to <i>PMBOK® Guide</i> processes and Knowledge Areas	Change or modification of <i>PMBOK® Guide</i> processes and/or Knowledge Areas
Discussion on the use of agile beyond software development	Removal of software industry influence on agile approaches. (Note that software is included in this practice guide even though the use of agile is growing in many other industries beyond software.)
Guidance, techniques, and approaches to consider when implementing agile in projects or organizations	Prescriptive step-by-step instructions on how to implement agile in projects or organizations
Definitions of generally accepted terms	New terms and/or definitions

This practice guide is for project teams who find themselves in the messy middle-ground between predictive and agile approaches, who are trying to address rapid innovation and complexity, and who are dedicated to the team’s improvement. This practice guide provides useful guidance for successful projects that deliver business value to meet customer expectations and needs.

This practice guide is organized as follows:

Section 2 An Introduction to Agile—This section includes the Agile Manifesto mindset, values, and principles. It also covers the concepts of definable and high-uncertainty work, and the correlation between lean, the Kanban Method, and agile approaches.

Section 3 Life Cycle Selection—This section introduces the various life cycles discussed in this practice guide. This section also addresses suitability filters, tailoring guidelines, and common combinations of approaches.

Section 4 Implementing Agile: Creating an Agile Environment—This section discusses critical factors to consider when creating an agile environment such as servant leadership and team composition.

Section 5 Implementing Agile: Delivering in an Agile Environment—This section includes information on how to organize teams and common practices teams can use for delivering value on a regular basis. It provides examples of empirical measurements for teams and for reporting status.

Section 6 Organizational Considerations for Project Agility—This section explores organizational factors that impact the use of agile approaches, such as culture, readiness, business practices, and the role of a PMO.

Section 7 A Call to Action—The call to action requests input for continuous improvement of this practice guide.

The annexes, appendixes, references, bibliography, and glossary provide additional useful information and definitions:

- ◆ **Annexes.** Contain mandatory information that is too lengthy for inclusion in the main body of the practice guide.
- ◆ **Appendixes.** Contain nonmandatory information that supplements the main body of this practice guide.
- ◆ **References.** Identify where to locate standards and other publications that are cited in this practice guide.
- ◆ **Bibliography.** Lists additional publications by section that provide detailed information on topics covered in this practice guide.
- ◆ **Glossary.** Presents a list of terms and their definitions that are used in this practice guide.



2

AN INTRODUCTION TO AGILE

2.1 DEFINABLE WORK VS. HIGH-UNCERTAINTY WORK

Project work ranges from definable work to high-uncertainty work. Definable work projects are characterized by clear procedures that have proved successful on similar projects in the past. The production of a car, electrical appliance, or home after the design is complete are examples of definable work. The production domain and processes involved are usually well understood and there are typically low levels of execution uncertainty and risk.

New design, problem solving, and not-done-before work is exploratory. It requires subject matter experts to collaborate and solve problems to create a solution. Examples of people encountering high-uncertainty work include software systems engineers, product designers, doctors, teachers, lawyers, and many problem-solving engineers. As more definable work is automated, project teams are undertaking more high-uncertainty work projects that require the techniques described in this practice guide.

High-uncertainty projects have high rates of change, complexity, and risk. These characteristics can present problems for traditional predictive approaches that aim to determine the bulk of the requirements upfront and control changes through a change request process. Instead, agile approaches were created to explore feasibility in short cycles and quickly adapt based on evaluation and feedback.



2.2 THE AGILE MANIFESTO AND MINDSET

Thought leaders in the software industry formalized the agile movement in 2001 with the publication of the Manifesto for Agile Software Development (see Figure 2-1).

We are uncovering better ways of developing software by doing it and helping others do it. Through this work we have come to value:

Individuals and interactions over processes and tools

Working software over comprehensive documentation

Customer collaboration over contract negotiation

Responding to change over following a plan

That is, while there is value in the items on the right, we value the items on the left more.

© 2001, the Agile Manifesto authors

Figure 2-1. The Four Values of the Agile Manifesto

Twelve clarifying principles flowed from these values as shown in Figure 2-2.

- 1.** Our highest priority is to satisfy the customer through early and continuous delivery of valuable software.
- 2.** Welcome changing requirements, even late in development. Agile processes harness change for the customer's competitive advantage.
- 3.** Deliver working software frequently, from a couple of weeks to a couple of months, with a preference to the shorter timescale.
- 4.** Business people and developers must work together daily throughout the project.
- 5.** Build projects around motivated individuals. Give them the environment and support they need, and trust them to get the job done.
- 6.** The most efficient and effective method of conveying information to and within a development team is face-to-face conversation.
- 7.** Working software is the primary measure of progress.
- 8.** Agile processes promote sustainable development. The sponsors, developers, and users should be able to maintain a constant pace indefinitely.
- 9.** Continuous attention to technical excellence and good design enhances agility.
- 10.** Simplicity—the art of maximizing the amount of work not done—is essential.
- 11.** The best architectures, requirements, and designs emerge from self-organizing teams.
- 12.** At regular intervals, the team reflects on how to become more effective, then tunes and adjusts its behavior accordingly.

Figure 2-2. The Twelve Principles Behind the Agile Manifesto



Although originating in the software industry, these principles have since spread to many other industries.

This embodiment of mindset, values, and principles defines what constitutes an agile approach. The various agile approaches in use today share common roots with the agile mindset, value, and principles. This relationship is shown in Figure 2-3.

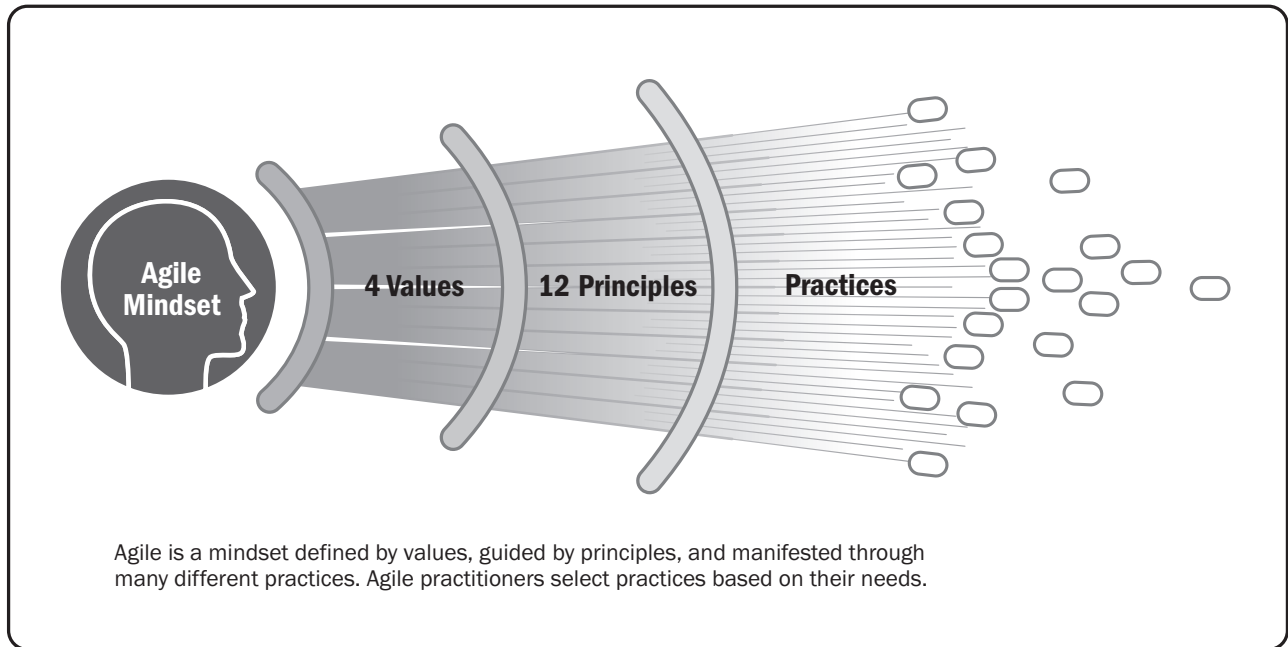

Figure 2-3. The Relationship Between the Agile Manifesto Values, Principles, and Common Practices

As shown in Figure 2-3, the model, inspired by Ahmed Sidky, articulates agile as a mindset defined by the Agile Manifesto values, guided by the Agile Manifesto principles, and enabled by various practices. It is worth noting that while the term “agile” became popularized after the Manifesto, the approaches and techniques being used by project teams today existed before the Agile Manifesto by many years and, in some cases, decades.

Agile approaches and *agile methods* are umbrella terms that cover a variety of frameworks and methods. Figure 2-4 places agile in context and visualizes it as a blanket term, referring to any kind of approach, technique, framework, method, or practice that fulfills the values and principles of the Agile Manifesto. Figure 2-4 also shows agile and the Kanban Method as subsets of lean. This is because they are named instances of lean thinking that share lean concepts such as: “focus on value,” “small batch sizes,” and “elimination of waste.”

Is agile an approach, a method, a practice, a technique, or a framework? Any or all of these terms could apply depending on the situation. This practice guide, uses the term “approach” unless one of the other terms is obviously more correct.

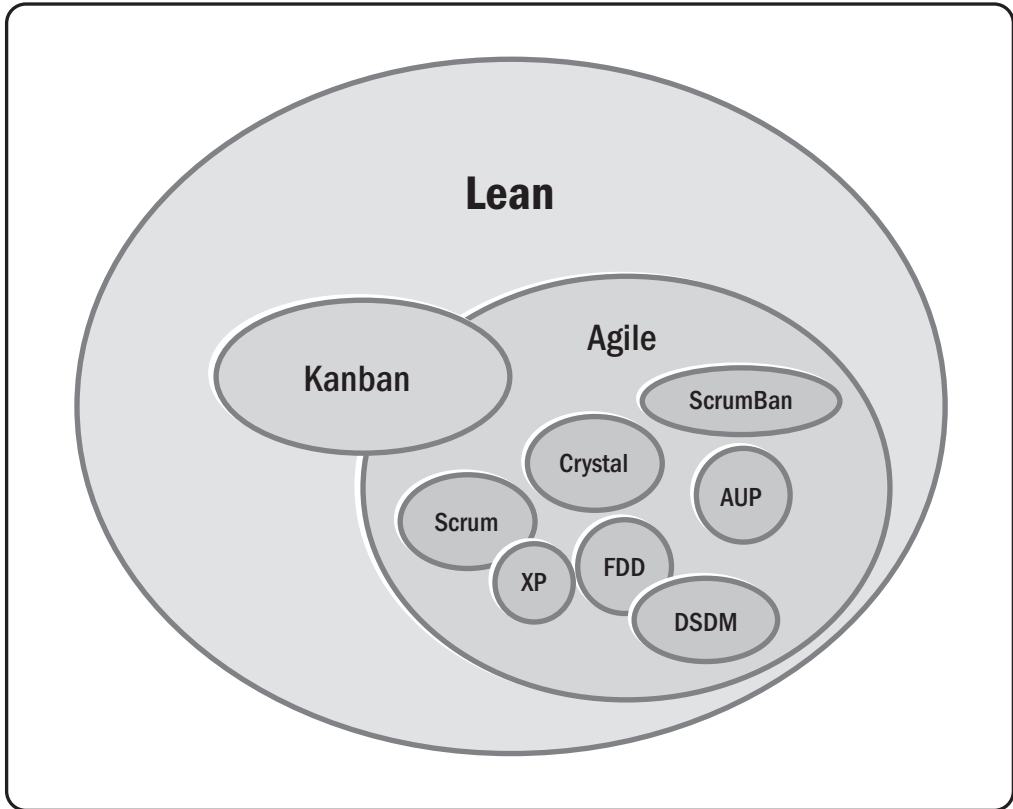

Figure 2-4. Agile is a Blanket Term for Many Approaches



In general, there are two strategies to fulfill agile values and principles. The first is to adopt a formal agile approach, intentionally designed and proven to achieve desired results. Then take time to learn and understand the agile approaches before changing or tailoring them. Premature and haphazard tailoring can minimize the effects of the approach and thus limit benefits. *(See Appendix X2 for Tailoring Considerations).*

The second strategy is to implement changes to project practices in a manner that fits the project context to achieve progress on a core value or principle. Use timeboxes to create features, or specific techniques to iteratively refine features. Consider dividing up one large project into several releases, if that works for the specific project context. Implement changes that will help the project succeed—the changes do not need to be part of the organization’s formal practices. The end goal is not to be agile for its own sake, but rather to deliver a continuous flow of value to customers and achieve better business outcomes.

2.3 LEAN AND THE KANBAN METHOD

One way to think about the relationship between lean, agile, and the Kanban Method is to consider agile and the Kanban Method as descendants of lean thinking. In other words, lean thinking is a superset, sharing attributes with agile and Kanban.

This shared heritage is very similar and focuses on delivering value, respect for people, minimizing waste, being transparent, adapting to change, and continuously improving. Project teams sometimes find it useful to blend various methods—whatever works for the organization or team is what should be done regardless of its origin. The objective is the best outcome regardless of the approach used.

The Kanban Method is inspired by the original lean-manufacturing system and used specifically for knowledge work. It emerged in the mid-2000s as an alternative to the agile methods that were prevalent at the time.

The Kanban Method is less prescriptive than some agile approaches and less disruptive, as it is the original “start-where-you-are” approach. Project teams can begin applying the Kanban Method with relative ease and progress toward other agile approaches if that is what they deem necessary or appropriate. For more details on the Kanban Method, see Annex A3 on Overview of Agile and Lean Frameworks.

CASE



There is and probably always will be a lot of discussion around the Kanban Method and whether it belongs to the lean or agile movement. It was conceived in and around lean manufacturing, but is widely used in agile settings.



2.4 UNCERTAINTY, RISK, AND LIFE CYCLE SELECTION

Some projects have considerable uncertainty around project requirements and how to fulfill those requirements using current knowledge and technology. These uncertainties can contribute to high rates of change and project complexity. These characteristics are illustrated in Figure 2-5.

As project uncertainty increases, so too does the risk of rework and the need to use a different approach. To mitigate the impact of these risks, teams select life cycles that allow them to tackle projects with high amounts of uncertainty via small increments of work.

Teams can verify their work when they use small increments and can change what they do next. When teams deliver small increments, they are better able to understand the true customer requirements faster and more accurately than with a static written specification.

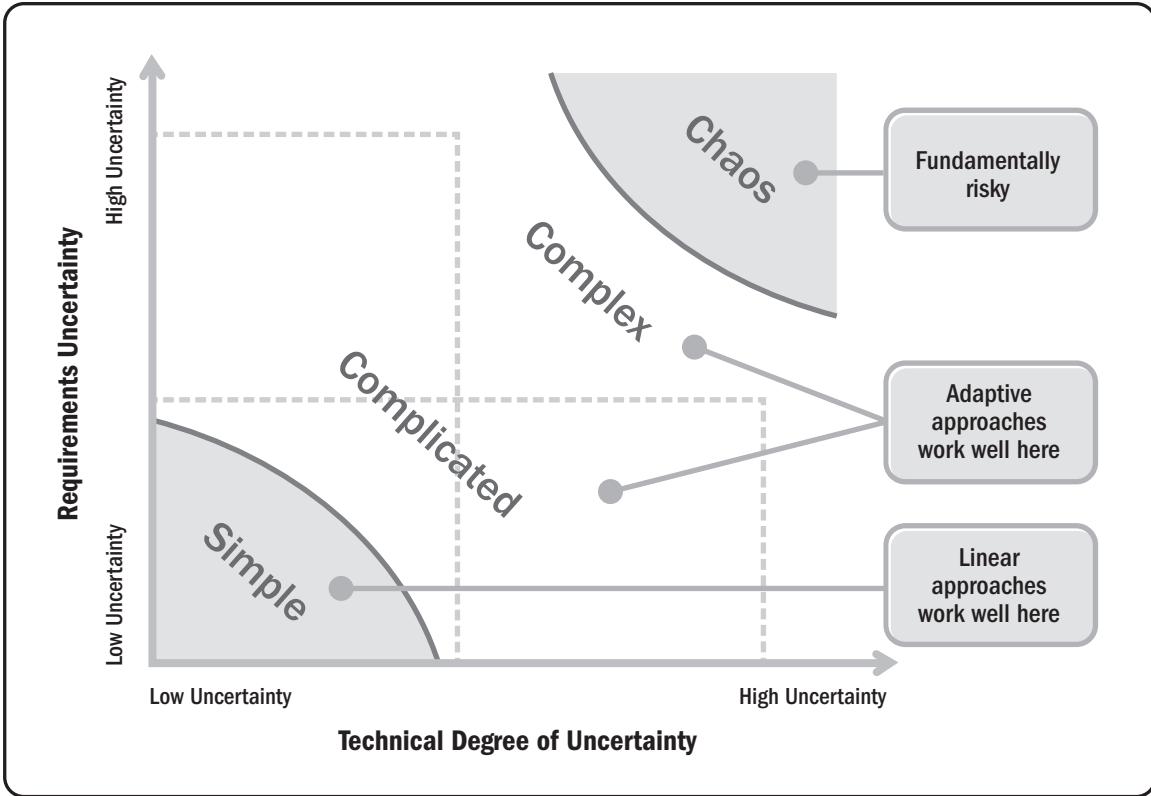



Figure 2-5. Uncertainty and Complexity Model Inspired by the Stacey Complexity Model

Teams can plan and manage projects with clear and stable requirements and clear technical challenges with little difficulty. However, as the uncertainty in the project increases, the likelihood of changes, wasted work, and rework also increases, which is costly and time consuming.



Some teams have evolved project life cycles to use iterative and incremental approaches. Many teams discover that when they explore the requirements iteratively and deliver more often incrementally, the teams adapt to changes more easily. These iterative and incremental approaches reduce waste and rework because the teams gain feedback. These approaches use:

- ◆ Very short feedback loops,
- ◆ Frequent adaptation of process,
- ◆ Reprioritization,
- ◆ Regularly updated plans, and
- ◆ Frequent delivery.



What do simple, complicated, and complex projects mean? Consider large projects, such as the Boston Big Dig construction project. On the surface, the project seemed fairly straightforward: move the elevated highway underground. There was high agreement on the requirements (see the Y axis in Figure 2-5). There was low uncertainty on how the project would proceed until the project started. And, as is the case for many large projects, the project encountered surprises along the way.

TIP

When a team works on a project where there is little opportunity for interim deliverables or little opportunity for prototyping, the team most likely will use a predictive life cycle to manage it. The team can adapt to what it discovers, but will not be able to use agile approaches to manage the iterative discovery of requirements or incremental deliverables for feedback.

The Big Dig project was not simple by any means. However, many projects that start out in the lower left part of the Stacey Complexity Model have no real means of moving to other approaches. Assess the project, both in the requirements and the means of delivery, to determine the best approach for the life cycle of the project.

These iterative, incremental, and agile approaches work well for projects that involve new or novel tools, techniques, materials, or application domains. (Refer to Section 3 on Life Cycle Selection). They also work well for projects that:

- ◆ Require research and development;
- ◆ Have high rates of change;
- ◆ Have unclear or unknown requirements, uncertainty, or risk; or
- ◆ Have a final goal that is hard to describe.

By building a small increment and then testing and reviewing it, the team can explore uncertainty at a low cost in a short time, reduce risk, and maximize business value delivery. This uncertainty may be centered on suitability and requirements (is the right product being built?); technical feasibility and performance (can this product be built this way?); or process and people (is this an effective way for the team to work?). All three of these characteristics—product specification, production capability, and process suitability—typically have elements of high uncertainty.

However, iterative and incremental approaches have their limits of applicability. When both technology uncertainty and requirements uncertainty are very high (the top right of Figure 2-5), the project moves beyond complex to chaotic. In order for the project to become reliably possible, it needs one of the variables (uncertainty or disagreement) to be contained.



3

LIFE CYCLE SELECTION

Projects come in many shapes and there are a variety of ways to undertake them. Project teams need awareness of the characteristics and options available to select the approach most likely to be successful for the situation.

This practice guide refers to four types of life cycles, defined as follows:

- ◆ **Predictive life cycle.** A more traditional approach, with the bulk of planning occurring upfront, then executing in a single pass; a sequential process.
- ◆ **Iterative life cycle.** An approach that allows feedback for unfinished work to improve and modify that work.
- ◆ **Incremental life cycle.** An approach that provides finished deliverables that the customer may be able to use immediately.
- ◆ **Agile life cycle.** An approach that is both iterative and incremental to refine work items and deliver frequently.

WHAT TO CALL NON-AGILE APPROACHES?

There is no single term that is universally used to describe non-agile approaches. Initially, the practice guide used the term *plan-driven* to describe the emphasis on an upfront plan and then execution of that plan. Some people prefer the terms *waterfall* or *serial* to describe this life cycle. In the end, we settled on the term *predictive* since it is used in *A Guide to the Project Management Body of Knowledge (PMBOK® Guide)* [3] and the *Software Extension to the PMBOK® Guide Fifth Edition* [4].

Many organizations do not experience either of these extremes and instead occupy some middle ground. That is natural, but we still need a way to talk about both ends of the spectrum. If *agile* is at one end, we call the other end *predictive*.



3.1 CHARACTERISTICS OF PROJECT LIFE CYCLES

Table 3-1 summarizes the characteristics of the four life cycle categories covered in this practice guide.

Table 3-1. Characteristics of Four Categories of Life Cycles

Characteristics				
Approach	Requirements	Activities	Delivery	Goal
Predictive	Fixed	Performed once for the entire project	Single delivery	Manage cost
Iterative	Dynamic	Repeated until correct	Single delivery	Correctness of solution
Incremental	Dynamic	Performed once for a given increment	Frequent smaller deliveries	Speed
Agile	Dynamic	Repeated until correct	Frequent small deliveries	Customer value via frequent deliveries and feedback

It is important to note that all projects have these characteristics—no project is completely devoid of considerations around requirements, delivery, change, and goals. A project’s inherent characteristics determine which life cycle is the best fit for that project.

Another way to understand how project life cycles vary is by using a continuum ranging from predictive cycles on one end, to agile cycles on the other end, with more iterative or incremental cycles in the middle.

Figure X3-1 of Appendix X3 of the *PMBOK® Guide – Sixth Edition* displays the continuum as a flat line. This view emphasizes the shifting of project characteristics from one end to the other. Another way to visualize the continuum is with a two-dimensional square, as shown in Figure 3-1.

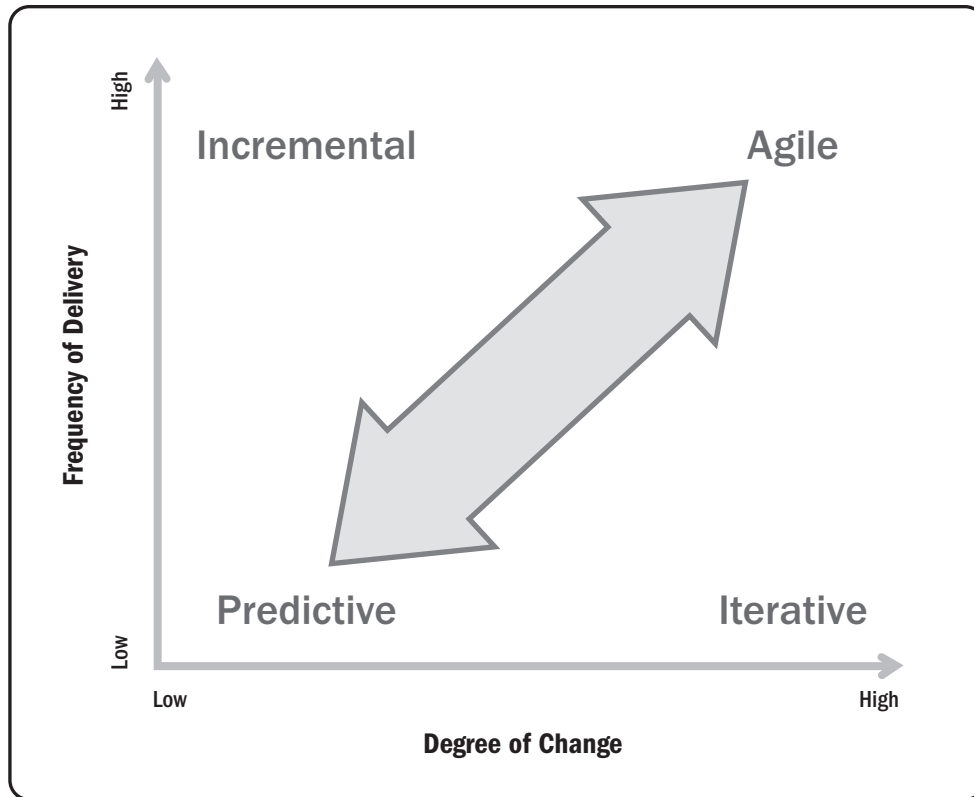

Figure 3-1. The Continuum of Life Cycles

No life cycle can be perfect for all projects. Instead, each project finds a spot on the continuum that provides an optimum balance of characteristics for its context. Specifically,

- ◆ **Predictive life cycles.** Take advantage of things that are known and proven. This reduced uncertainty and complexity allows teams to segment work into a sequence of predictable groupings.
- ◆ **Iterative life cycles.** Allow feedback on partially completed or unfinished work to improve and modify that work.
- ◆ **Incremental life cycles.** Provide finished deliverables that the customer may be able to use immediately.
- ◆ **Agile life cycles.** Leverage both the aspects of iterative and incremental characteristics. When teams use agile approaches, they iterate over the product to create finished deliverables. The team gains early feedback and provides customer visibility, confidence, and control of the product. Because the team can release earlier, the project may provide an earlier return on investment because the team delivers the highest value work first.

PLANNING IS ALWAYS THERE

A key thing to remember about life cycles is that each of them share the element of planning. What differentiates a life cycle is not whether planning is done, but rather how much planning is done and when.

At the predictive end of the continuum, the plan drives the work. As much planning as is possible is performed upfront. Requirements are identified in as much detail as possible. The team estimates when they can deliver which deliverables and performs comprehensive procurement activities.

In iterative approaches, prototypes and proofs are also planned, but the outputs are intended to modify the plans created in the beginning. Earlier reviews of unfinished work help inform future project work.

Meanwhile, incremental initiatives plan to deliver successive subsets of the overall project. Teams may plan several successive deliveries in advance or only one at a time. The deliveries inform the future project work.

Agile projects also plan. The key difference is that the team plans and replans as more information becomes available from review of frequent deliveries. Regardless of the project life cycle, the project requires planning.

3.1.1 CHARACTERISTICS OF PREDICTIVE LIFE CYCLES

Predictive life cycles expect to take advantage of high certainty around firm requirements, a stable team, and low risk. As a result, project activities often execute in a serial manner, as shown in Figure 3-2.

In order to achieve this approach, the team requires detailed plans to know what to deliver and how. These projects succeed when other potential changes are restricted (e.g., requirements changes; project team members change what the team delivers). Team leaders aim to minimize change for the predictive project.

When the team creates detailed requirements and plans at the beginning of the project, they can articulate the constraints. The team can then use those constraints to manage risk and cost. As the team progresses through the detailed plan, they monitor and control changes that might affect the scope, schedule, or budget.

By emphasizing a departmentally efficient, serialized sequence of work, predictive projects do not typically deliver business value until the end of the project. If the predictive project encounters changes or disagreements with the requirements, or if the technological solution is no longer straightforward, the predictive project will incur unanticipated costs.

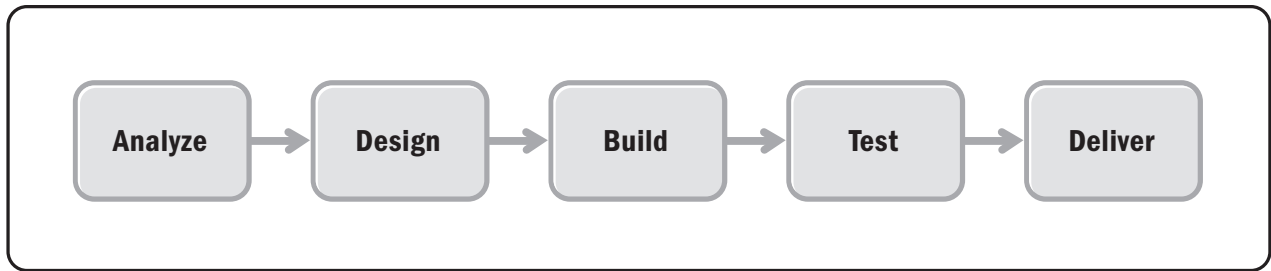

Figure 3-2. Predictive Life Cycle

3.1.2 CHARACTERISTICS OF ITERATIVE LIFE CYCLES

Iterative life cycles improve the product or result through successive prototypes or proofs of concept. Each new prototype yields new stakeholder feedback and team insights. Then, the team incorporates the new information by repeating one or more project activities in the next cycle. Teams may use timeboxing on a given iteration for a few weeks, gather insights, and then rework the activity based on those insights. In that way, iterations help identify and reduce uncertainty in the project.

Projects benefit from iterative life cycles when complexity is high, when the project incurs frequent changes, or when the scope is subject to differing stakeholders' views of the desired final product. Iterative life cycles may take longer because they are optimized for learning rather than speed of delivery.

Figure 3-3 illustrates some elements of an iterative project life cycle for a single product delivery.

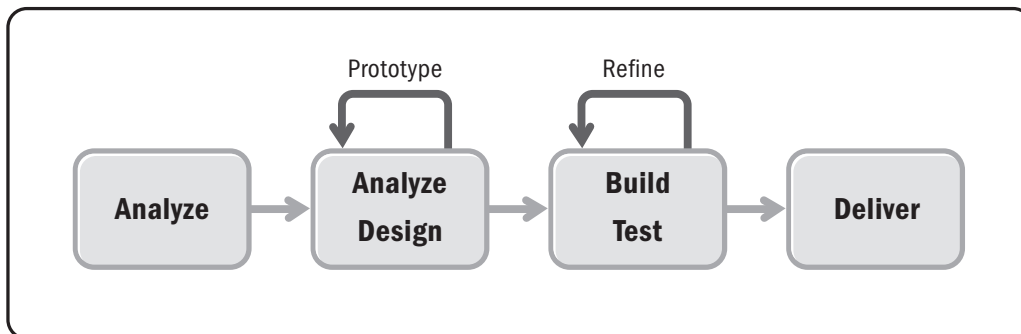

Figure 3-3. Iterative Life Cycle

Have you ever been involved on a project where the requirements seemed to change daily and thought, “We will know the requirements when we deliver a prototype that the business approves.” If so, this was a project where agile approaches could have helped. A prototype encourages feedback and a better understanding of the requirements that can be incorporated into each deliverable.

3.1.3 CHARACTERISTICS OF INCREMENTAL LIFE CYCLES

Some projects optimize for speed of delivery. Many businesses and initiatives cannot afford to wait for everything to be completed; in these cases, customers are willing to receive a subset of the overall solution. This frequent delivery of smaller deliverables is called an incremental life cycle (see Figure 3-4).

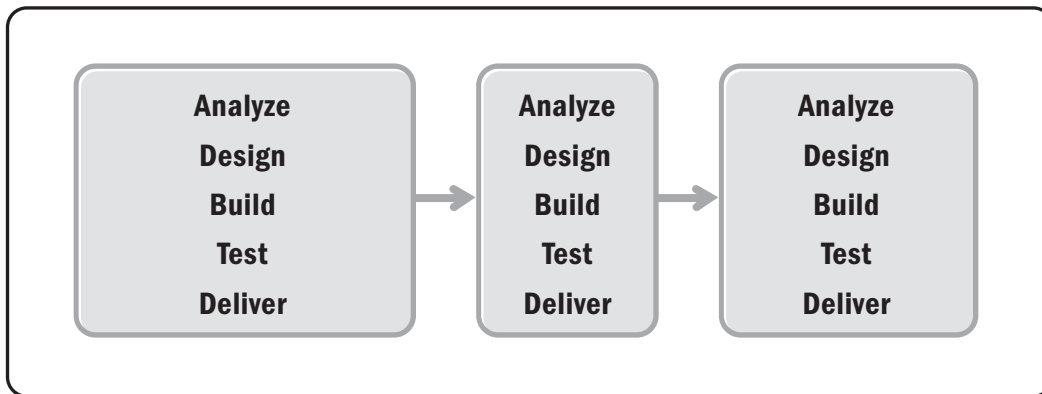

Figure 3-4. A Life Cycle of Varying-Sized Increments

TIP

Are you unsure of how a new business service might work in practice? Create a proof of concept with evaluation criteria to explore desired outcomes. Use iterative approaches when you suspect the requirements will change based on customer feedback.

Incremental life cycles optimize work for delivering value to sponsors or customers more often than a single, final product. Teams plan initial deliverables before beginning their work, and they begin working on that first delivery as soon as possible. Some agile projects deliver value within days of project initiation. Others could take longer, ranging from 1 week to several weeks.

As the project continues, the team may deviate from the original vision. The team can manage the deviations, because the team delivers value sooner. The degree of change and variation is less important than ensuring customers get value sooner than at the end of the project.

Providing a customer a single feature or a finished piece of work is an example of the incremental approach.

For example, builders may want to show a finished room or floor of a building before they continue with the remainder of the building. In that case, they may complete a floor with fixtures, paint, and everything else intended for the finished floor before proceeding to the next floor. The customer is able to see and approve of the style, color, and other details, allowing adjustments to be made before further investments of time and money are made. This reduces potential rework and/or customer dissatisfaction.

Completeness and delivery are subjective. The team may need feedback on a prototype and may then choose to deliver a minimum viable product (MVP) to a subset of customers. The customers' feedback helps the team to learn what they need to provide for subsequent delivery of the final finished feature.

Agile teams, as a key differentiator, deliver business value often. As the product adds a broader set of features and a broader range of consumers, we say it is delivered incrementally.



3.1.4 CHARACTERISTICS OF AGILE LIFE CYCLES

In an agile environment, the team expects requirements to change. The iterative and incremental approaches provide feedback to better plan the next part of the project. However, in agile projects, incremental delivery uncovers hidden or misunderstood requirements. Figure 3-5 illustrates two possible ways to achieve incremental delivery so the project aligns with customer needs and can be adapted as necessary.

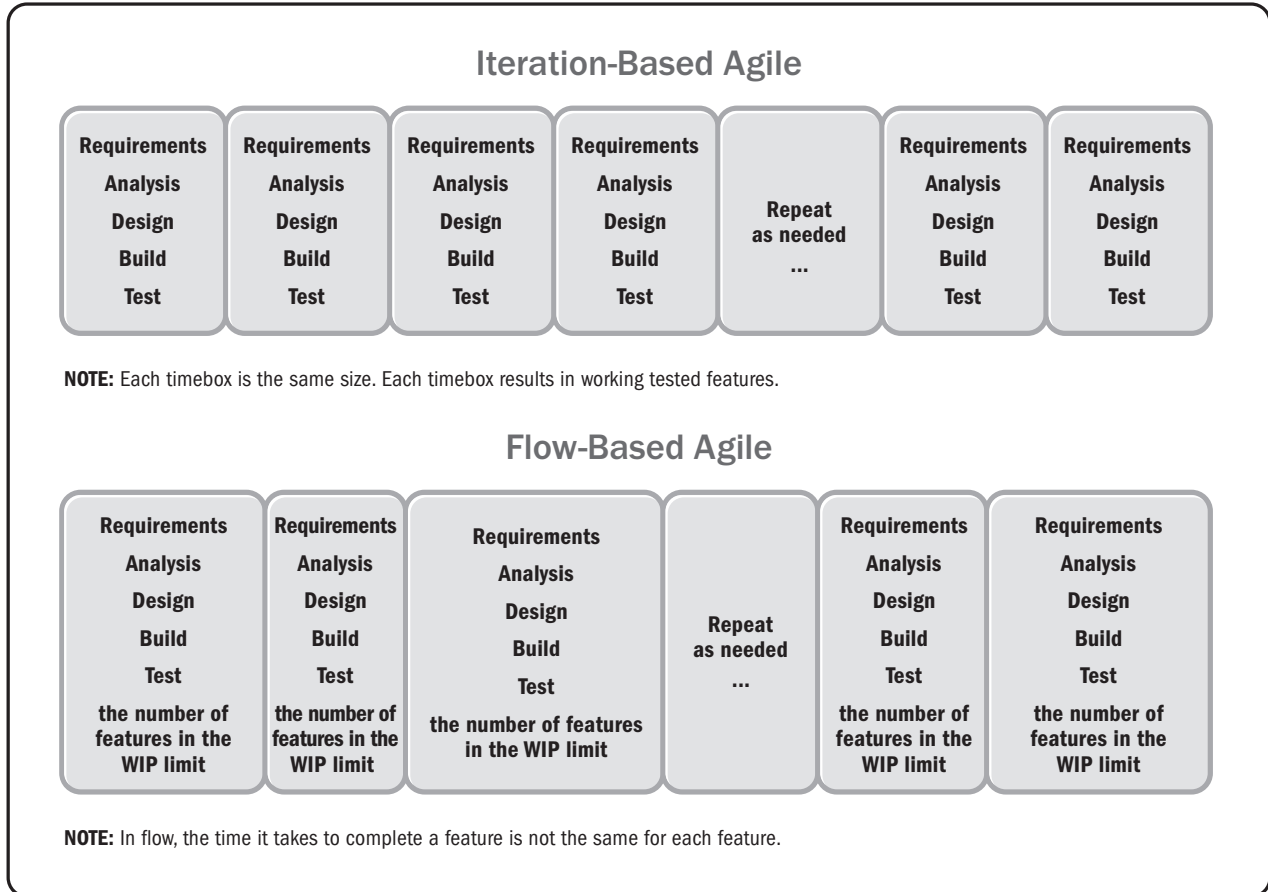

Figure 3-5. Iteration-Based and Flow-Based Agile Life Cycles

In iteration-based agile, the team works in iterations (timeboxes of equal duration) to deliver completed features. The team works on the most important feature, collaborating as a team to finish it. Then the team works on the next most important feature and finishes it. The team may decide to work on a few features at a time, but the team does not address all of the work for the iteration at once (i.e., does not address all of the requirements, followed by all of the analyses, etc.).

In flow-based agile, the team pulls features from the backlog based on its capacity to start work rather than on an iteration-based schedule. The team defines its workflow with columns on a task board and manages the work in progress for each column. Each feature may take a different amount of time to finish. Teams keep work-in-progress sizes small to better identify issues early and reduce rework should changes be required. Without iterations to define planning and review points, the team and business stakeholders determine the most appropriate schedule for planning, product reviews, and retrospectives.

Agile life cycles are those that fulfill the principles of the Agile Manifesto. In particular, customer satisfaction increases with early and continuous delivery of valuable products. Moreover, an incremental deliverable that is functional and provides value is the primary measure of progress. Agile life cycles combine both iterative and incremental approaches in order to adapt to high degrees of change and deliver project value more often.

3.1.5 AGILE SUITABILITY FILTERS

Various assessment models exist to help determine the likely fit or gaps for using agile approaches. These models assess project and organizational factors associated with adoption and suitability and then provide scores indicating alignment or potential risk areas. Appendix X3 provides a synthesis of popular assessment models for use as an agile suitability filter.

EXAMPLE OF A HYBRID LIFE CYCLE PROJECT

A pharmaceutical company that had a time-consuming U.S. Food and Drug Administration (FDA) approval process tagged onto the end of its development process and its entire life cycle looked like Figure 3-6. While project teams undertook drug trials in an agile fashion, they had to present the drugs to an external group to perform the FDA approval process. A consultant helped to integrate the FDA approval process portion into the agile development process to create a more streamlined hybrid approach.

The short version of the story is that because FDA approval is required to be completed at the end of the development process or repeated after any change (this includes even after the most minor change), the process had to remain at the end as a separate phase. Integration using the iterative process was unsuccessful. However, the consultant created some useful quick-start guides and testing protocols that shortened the final FDA approval process.

3.1.6 CHARACTERISTICS OF HYBRID LIFE CYCLES

It is not necessary to use a single approach for an entire project. Projects often combine elements of different life cycles in order to achieve certain goals. A combination of predictive, iterative, incremental, and/or agile approaches is a hybrid approach.

Figure 3-6 depicts the basic, pure approaches to project types that combine to form a hybrid model. The early processes utilize an agile development life cycle, which is then followed by a predictive rollout phase. This approach can be used when there is uncertainty, complexity, and risk in the development portion of the project that would benefit from an agile approach, followed by a defined, repeatable rollout phase that is appropriate to undertake in a predictive way, perhaps by a different team. An example of this approach is the development of a new high-tech product followed by rollout and training to thousands of users.

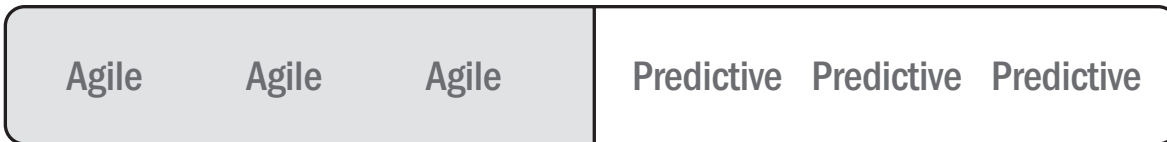

Figure 3-6. Agile Development Followed by a Predictive Rollout

3.1.7 COMBINED AGILE AND PREDICTIVE APPROACHES

Another approach is to use a combination of agile and predictive approaches throughout the life cycle.

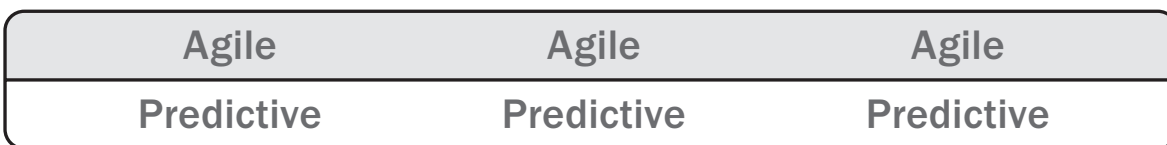

Figure 3-7. A Combined Agile and Predictive Approach Used Simultaneously

In Figure 3-7, a combination of both predictive and agile approaches are used in the same project. Perhaps the team is incrementally transitioning to agile and using some approaches like short iterations, daily standups, and retrospectives, but other aspects of the project such as upfront estimation, work assignment, and progress tracking are still following predictive approaches.

Using both predictive and agile approaches is a common scenario. It would be misleading to call the approach agile since it clearly does not fully embody the agile mindset, values, and principles. However, it would also be inaccurate to call it predictive since it is a hybrid approach.



3.1.8 PREDOMINANTLY PREDICTIVE APPROACH WITH SOME AGILE COMPONENTS

Figure 3-8 shows a small agile element within a chiefly predictive project. In this case, a portion of the project with uncertainty, complexity, or opportunity for scope creep is being tackled in an agile way, but the remainder of the project is being managed using predictive approaches. An example of this approach would be an engineering firm that is building a facility with a new component.

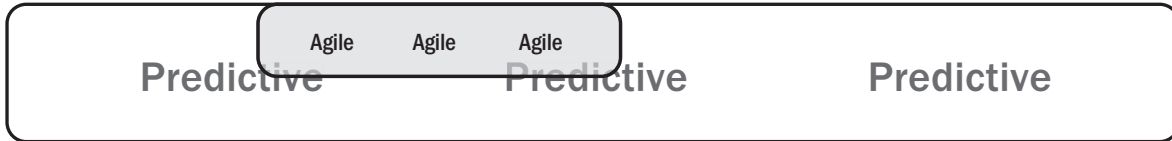

Figure 3-8. A Largely Predictive Approach with Agile Components

While the majority of the project may be routine and predictable, like many other facility projects the organization has undertaken before, this project incorporates a new roofing material. The contractor may plan for some small-scale installation trials on the ground first to determine the best installation method and to uncover issues early while there is plenty of time to solve them and incrementally improve processes through experimentation and adaptation.

3.1.9 A LARGELY AGILE APPROACH WITH A PREDICTIVE COMPONENT

Figure 3-9 depicts a largely agile approach with a predictive component. This approach might be used when a particular element is non-negotiable or not executable using an agile approach. Examples include integrating an external component developed by a different vendor that cannot or will not partner in a collaborative or incremental way. A single integration is required after the component is delivered.

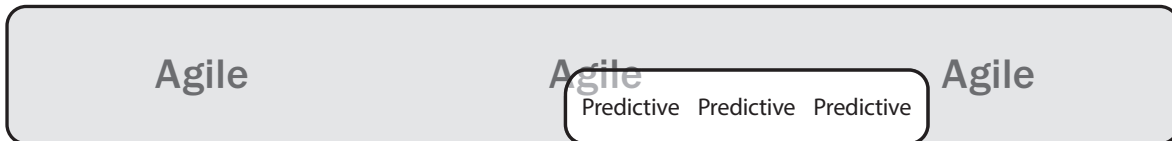

Figure 3-9. A Largely Agile Approach with a Predictive Component

A government department had a credit insurance application development project. The multi-year project was to replace its aging underwriting system with a new, more responsive user interface and system integrations. The bulk of the project was undertaken using an agile approach with continual business input.

The premium rate calculations were handed down from the Organisation for Economic Co-operation and Development (OECD) as a 200-page specification. The steps were very clearly explained with little opportunity for confusion (or interim result confirmation by the business) and were coded up by a separate team working its way through the calculation steps. The two teams collaborated on the input variables required for the calculation and how to consume and display the output values, but beyond that, the calculation team worked in a largely predictive manner.

When the calculation team's portion was complete, the outputs from the premium rate calculations were displayed on the screens and in the reports. Then the business users provided feedback on the appearance and use of the information. The two teams ran concurrently, but had little need for interaction. Having them physically close to each other made it easier to check in on development progress, but largely they were separate subprojects.

3.1.10 HYBRID LIFE CYCLES AS FIT-FOR-PURPOSE

Project teams may design a hybrid life cycle based on project risks. For example, a campus construction project may have multiple buildings to improve and build. An incremental approach would focus resources on completing some buildings earlier than others, accelerating the return on investment. Each individual delivery may be sufficiently well known to benefit from a predictive life cycle for that building alone.

The goal of project management is to produce business value in the best possible way given the current environment. It does not matter if that way is agile or predictive. The question to ask is: "How can we be most successful?"

Is feedback needed as the team produces value? If so, increments will help. Is it necessary to manage risk as ideas are explored? If so, iterations or agile will help.

When the organization cannot deliver intermediate value, agile approaches may not be useful. That is okay—agile for the sake of agile is not the goal. The point is to select a life cycle or a combination of life cycles that work for the project, the risks, and the culture.

Agile is about customer-based delivery on a frequent basis. That delivery creates feedback for the team. The team uses that feedback to plan and replan the next chunk of work.

3.1.11 HYBRID LIFE CYCLES AS TRANSITION STRATEGY

Many teams are not able to make the switch to agile ways of working overnight. Agile techniques look and feel very different to those who are accustomed to and have been successful in a predictive environment. The larger the organization and the more moving parts, the longer it will take to transition. For that reason, it makes sense to plan a gradual transition.

A gradual transition involves adding more iterative techniques to improve learning and alignment among teams and stakeholders. Later, consider adding more incremental techniques to accelerate value and return on investment to sponsors. This combination of various approaches is considered a hybrid approach.

Try these new techniques on a less risky project with a medium- to low-degree of uncertainty. Then, when the organization is successful with a hybrid approach, try more complex projects that require more of those techniques to be added. This is a way to tailor the progressive hybrid transition to the organization's situation and specific risks and the team's readiness to adapt and embrace the changes.



3.2 MIXING AGILE APPROACHES

Agile teams rarely limit their practices to one agile approach. Each project context has its own peculiarities, such as the varied mix of team member skills and backgrounds; the various components of the product under development; and the age, scale, criticality, complexity, and regulatory constraints of the environment in which the work takes place.

Agile frameworks are not customized for the team. The team may need to tailor practices to deliver value on a regular basis. Often, teams practice their own special blend of agile, even if they use a particular framework as a starting point.

BLENDING APPROACHES

As an example of tailoring agile frameworks, one of the most common blends in widespread use involves a coordinated use of the Scrum framework, the Kanban Method, and elements of the eXtreme Programming (XP) method. Scrum provides guidance on the use of a product backlog, a product owner, scrum master, and a cross-functional development team, including sprint planning, daily scrum, sprint review, and sprint retrospective sessions. A kanban board helps the team to further improve its effectiveness by visualizing the flow of work, making impediments easily visible, and allowing flow to be managed by adjusting work in process limits. In addition, XP-inspired engineering practices such as use of story cards, continuous integration, refactoring, automated testing, and test-driven development further increase the effectiveness of the agile team. In summary, the blend of practices from these various sources produces a synergistic result of higher performance than each individual component in isolation.



3.3 PROJECT FACTORS THAT INFLUENCE TAILORING

Sometimes project attributes require tailoring an approach for a better fit. Table 3-2 identifies some project factors and tailoring options to consider.

Table 3-2. Tailoring Options to Improve Fit

Project Factor	Tailoring Options
Demand pattern: steady or sporadic	Many teams find that using a cadence (in the form of a regular timebox) helps them demo, retrospect, and take in new work. In addition, some teams need more flexibility in their acceptance of more work. Teams can use flow-based agile with a cadence to get the best of both worlds.
Rate of process improvement required by the level of team experience	Retrospect more often and select improvements.
The flow of work is often interrupted by various delays or impediments	Consider making work visible using kanban boards and experimenting with limits for the various areas of the work process in order to improve flow.
The quality of the product increments is poor	Consider using the various test-driven development practices. This mistake-proofing discipline makes it difficult for defects to remain undetected.
More than one team is needed to build a product	To scale from one to several agile teams, with minimal disruption, first learn about agile program management or formal scaling frameworks. Then, craft an approach that fits the project context.
The project team members are inexperienced in the use of agile approaches	Consider starting by training team members in the fundamentals of the agile mindset and principles. If the team decides to use a specific approach such as Scrum or Kanban, provide a workshop on that approach so the team members can learn how to use it.

For additional guidance on factors that influence tailoring see Appendix X2 on Attributes that Influence Tailoring.

4

IMPLEMENTING AGILE: CREATING AN AGILE ENVIRONMENT

4.1 START WITH AN AGILE MINDSET

Managing a project using an agile approach requires that the project team adopt an agile mindset. The answers to the following questions will help to develop an implementation strategy:

- ◆ How can the project team act in an agile manner?
- ◆ What can the team deliver quickly and obtain early feedback to benefit the next delivery cycle?
- ◆ How can the team act in a transparent manner?
- ◆ What work can be avoided in order to focus on high-priority items?
- ◆ How can a servant-leadership approach benefit the achievement of the team's goals?

4.2 SERVANT LEADERSHIP EMPOWERS THE TEAM

Agile approaches emphasize servant leadership as a way to empower teams. Servant leadership is the practice of leading through service to the team, by focusing on understanding and addressing the needs and development of team members in order to enable the highest possible team performance.

The role of a servant leader is to facilitate the team's discovery and definition of agile. Servant leaders practice and radiate agile. Servant leaders approach project work in this order:

- ◆ **Purpose.** Work with the team to define the “why” or purpose so they can engage and coalesce around the goal for the project. The entire team optimizes at the project level, not the person level.
- ◆ **People.** Once the purpose is established, encourage the team to create an environment where everyone can succeed. Ask each team member to contribute across the project work.
- ◆ **Process.** Do not plan on following the “perfect” agile process, but instead look for the results. When a cross-functional team delivers finished value often and reflects on the product and process, the teams are agile. It does not matter what the team calls its process.

The following characteristics of servant leadership enable project leaders to become more agile and facilitate the team's success:

- ◆ Promoting self-awareness;
- ◆ Listening;
- ◆ Serving those on the team;
- ◆ Helping people grow;
- ◆ Coaching vs. controlling;
- ◆ Promoting safety, respect, and trust; and
- ◆ Promoting the energy and intelligence of others.

Servant leadership is not unique to agile. But once having practiced it, servant leaders can usually see how well servant leadership integrates into the agile mindset and value.

When leaders develop their servant leadership or facilitative skills, they are more likely to become agile. As a result, servant leaders can help their teams collaborate to deliver value faster.

Successful agile teams embrace the growth mindset, where people believe they can learn new skills. When the team and the servant leaders believe they can all learn, everyone becomes more capable.

4.2.1 SERVANT LEADER RESPONSIBILITIES

Servant leaders manage relationships to build communication and coordination within the team and across the organization. These relationships help the leaders navigate the organization to support the team. This kind of support helps to remove impediments and facilitates the team to streamline its processes. Because servant leaders understand agile and practice a specific approach to agile, they can assist in fulfilling the team's needs.

4.2.1.1 SERVANT LEADERS FACILITATE

When project managers act as servant leaders, the emphasis shifts from “managing coordination” to “facilitating collaboration.” Facilitators help everyone do their best thinking and work. Facilitators encourage the team’s participation, understanding, and shared responsibility for the team’s output. Facilitators help the team create acceptable solutions.

Servant leaders promote collaboration and conversation within the team and between teams. For example, a servant leader helps to expose and communicate bottlenecks inside and between teams. Then the teams resolve those bottlenecks.

Additionally, a facilitator encourages collaboration through interactive meetings, informal dialog, and knowledge sharing. Servant leaders do this by becoming impartial bridge-builders and coaches, rather than by making decisions for which others should be responsible.

4.2.1.2 SERVANT LEADERS REMOVE ORGANIZATIONAL IMPEDIMENTS

The first value of the Agile Manifesto is individuals and interactions over processes and tools. What better responsibility for a servant leader to take on than to take a hard look at processes that are impeding a team’s or organization’s agility and work to streamline them? For example, if a department requires extensive documentation, the role of the servant leader could be to work with that department to review required documentation, assist with creating a shared understanding of how agile deliverables meet those requirements, and evaluate the amount of documentation required so teams are spending more time delivering a valuable product instead of producing exhaustive documentation.

Servant leaders should also look at other processes that are lengthy, causing bottlenecks and impeding a team’s or organization’s agility. Examples of processes or departments that may need to be addressed include finance, change control boards, or audits. Servant leaders can partner and work with others to challenge them to review their processes to support agile teams and leaders. For example, what good is it for the team to deliver working product every 2 weeks only to have the product fall into a queue or process that could take 6 or more weeks to release due to lengthy release processes? Far too many organizations have these “bottleneck” processes that prevent teams from quickly delivering valuable products or services. The servant leader has the ability to change or remove these organizational impediments to support delivery teams.

INTERPERSONAL SKILLS VERSUS TECHNICAL SKILLS

In addition to servant leadership, team members emphasize their interpersonal and emotional intelligence skills—not just technical skills. Everyone on the team works to exhibit more initiative, integrity, emotional intelligence, honesty, collaboration, humility, and willingness to communicate in various ways so that the entire team can work together well.

The team needs these skills so they can respond well to changes in project direction and technical product changes. When everyone can adapt to the work and to each other, the entire team is more likely to succeed.

4.2.1.3 SERVANT LEADERS PAVE THE WAY FOR OTHERS' CONTRIBUTION

In agile, the team manages its work process and its work product. That self-management and self-organization applies to everyone serving and supporting the organization and project. Servant leaders work to fulfill the needs of the teams, projects, and organization. Servant leaders may work with facilities for a team space, work with management to enable the team to focus on one project at a time, or work with the product owner to develop stories with the team. Some servant leaders work with auditors to refine the processes needed in regulatory environments, and some servant leaders work with the finance department to transition the organization to incremental budgeting.

The servant leader focuses on paving the way for the team to do its best work. The servant leader influences projects and encourages the organization to think differently.

4.2.1.4 CONSIDER THESE SERVANT LEADER RESPONSIBILITIES

Servant leaders can have many possible titles, but what is most important is what they do. Here are some examples of the responsibilities a servant leader may have:

- ◆ Educate stakeholders around why and how to be agile. Explain the benefits of business value based on prioritization, greater accountability and productivity of empowered teams, and improved quality from more frequent reviews, etc.
- ◆ Support the team through mentoring, encouragement, and support. Advocate for team members training and career development. The oxymoronic quote “We lead teams by standing behind them” speaks to the role of the leader in developing their team members. Through support, encouragement, and professional development, team members gain confidence, take on larger roles, and contribute at higher levels within their organizations. A key role of the servant leader is to nurture and grow team members through and beyond their current roles, even if that means losing them from the team.
- ◆ Help the team with technical project management activities like quantitative risk analysis. Sometimes team members may not have knowledge or experience in roles or functions. Servant leaders who may have more exposure or training in techniques can support the team by providing training or undertaking these activities.
- ◆ Celebrate team successes and support and bridge building activities with external groups. Create upward spirals of appreciation and good will for increased collaboration.

4.2.2 ROLE OF THE PROJECT MANAGER IN AN AGILE ENVIRONMENT

The role of the project manager in an agile project is somewhat of an unknown, because many agile frameworks and approaches do not address the role of the project manager. Some agile practitioners think the role of a project manager is not needed, due to self-organizing teams taking on the former responsibilities of the project manager. However, pragmatic agile practitioners and organizations realize that project managers can add significant value in many situations. The key difference is that their roles and responsibilities look somewhat different.

TIP

The value of project managers is not in their position, but in their ability to make everyone else better.

4.2.3 PROJECT MANAGERS USE SERVANT LEADERSHIP

The *PMBOK® Guide* – Sixth Edition, defines the project manager as “the person assigned by the performing organization to lead the team that is responsible for achieving the project objectives.”

Many project managers are accustomed to being at the center of coordination for the project, tracking and representing the team’s status to the rest of the organization. This approach was fine when projects were decomposed into siloed functions.

However, in high-change projects, there is more complexity than one person can manage. Instead, cross-functional teams coordinate their own work and collaborate with the business representative (the product owner).

When working on an agile project, project managers shift from being the center to serving the team and the management. In an agile environment, project managers are servant leaders, changing their emphasis to coaching people who want help, fostering greater collaboration on the team, and aligning stakeholder needs. As a servant leader, project managers encourage the distribution of responsibility to the team: to those people who have the knowledge to get work done.

4.3 TEAM COMPOSITION

A core tenet in both the values and the principles of the Agile Manifesto is the importance of individuals and interactions. Agile optimizes the flow of value, emphasizing rapid feature delivery to the customer, rather than on how people are “utilized.”

TIP

Build projects around motivated individuals. Give them the environment and support they need and trust them to get the job done.

When teams think about how to optimize the flow of value, the following benefits become apparent:

- ◆ People are more likely to collaborate.
- ◆ Teams finish valuable work faster.
- ◆ Teams waste much less time because they do not multitask and have to re-establish context.

4.3.1 AGILE TEAMS

Agile teams focus on rapid product development so they can obtain feedback. In practice, the most effective agile teams tend to range in size from three to nine members. Ideally, agile teams are colocated in a team space. Team members are 100% dedicated to the teams. Agile encourages self-managing teams, where team members decide who will perform the work within the next period's defined scope. Agile teams thrive with servant leadership. The leaders support the teams' approach to their work.

Cross-functional agile teams produce functional product increments frequently. That is because the teams collectively own the work and together have all of the necessary skills to deliver completed work.

Regardless of the overall agile approach, the more a team limits its work in progress, the more likely its members can collaborate to expedite work across the board. Team members in successful agile teams work to collaborate in various ways (such as pairing, swarming, and mobbing) so they do not fall into the trap of mini-waterfalls instead of collaborative work. Mini-waterfalls occur when the team addresses *all* of the requirements in a given period, then attempts to do *all* of the design, then moves on to do *all* of the building. Using this scenario, at some point in the building or the testing following the building, the team may realize it had assumptions that are no longer valid. In this case, the team wasted time in addressing *all* of the requirements. Instead, when team members collaborate to produce a small number of features across the board, they learn as they proceed and deliver smaller finished features.

Agile projects benefit from project team structures that improve collaboration within and among the teams. Table 4-1 shows how collaborative team members boost productivity and facilitate innovative problem solving.



Table 4-1. Attributes of Successful Agile Teams

Attribute	Goal
Dedicated people	<ul style="list-style-type: none"> • Increased focus and productivity • Small team, fewer than ten people
Cross-functional team members	<ul style="list-style-type: none"> • Develop and deliver often • Deliver finished value as an independent team • Integrate all the work activities to deliver finished work • Provide feedback from inside the team and from others, such as the product owner
Colocation or ability to manage any location challenges	<ul style="list-style-type: none"> • Better communication • Improved team dynamics • Knowledge sharing • Reduced cost of learning • Able to commit to working with each other
Mixed team of generalists and specialists	<ul style="list-style-type: none"> • Specialists provide dedicated expertise and generalists provide flexibility of who does what • Team brings their specialist capabilities and often become generalizing specialists, with a focus specialty plus breadth of experience across multiple skills
Stable work environment	<ul style="list-style-type: none"> • Depend on each other to deliver • Agreed-upon approach to the work • Simplified team cost calculations (run rate) • Preservation and expansion of intellectual capital

4.3.2 AGILE ROLES

In agile, three common roles are used:

- ◆ Cross-functional team members,
- ◆ Product owner, and
- ◆ Team facilitator.

Table 4-2 describes these team roles.

Table 4-2. Agile Team Roles

Role	Description
Cross-functional team member	<p>Cross-functional teams consist of team members with all the skills necessary to produce a working product. In software development, cross-functional teams are typically comprised of designers, developers, testers, and any other required roles. The cross-functional development teams consist of professionals who deliver potentially releasable product on a regular cadence. Cross-functional teams are critical because they can deliver finished work in the shortest possible time, with higher quality, without external dependencies.</p>
Product owner	<p>The product owner is responsible for guiding the direction of the product. Product owners rank the work based on its business value. Product owners work with their teams daily by providing product feedback and setting direction on the next piece of functionality to be developed/delivered. That means the work is small, often small enough to be described on one index card.</p> <p>The product owner works with stakeholders, customers, and the teams to define the product direction. Typically, product owners have a business background and bring deep subject matter expertise to the decisions. Sometimes, the product owner requests help from people with deep domain expertise, such as architects, or deep customer expertise, such as product managers. Product owners need training on how to organize and manage the flow of work through the team.</p> <p>In agile, the product owners create the backlog for and with the team. The backlog helps the teams see how to deliver the highest value without creating waste.</p> <p>A critical success factor for agile teams is strong product ownership. Without attention to the highest value for the customer, the agile team may create features that are not appreciated, or otherwise insufficiently valuable, therefore wasting effort.</p>
Team facilitator	<p>The third role typically seen on agile teams is of a team facilitator, a servant leader. This role may be called a project manager, scrum master, project team lead, team coach, or team facilitator.</p> <p>All agile teams need servant leadership on the team. People need time to build their servant leadership skills of facilitation, coaching, and impediment removal.</p> <p>Initially, many organizations invite external agile coaches to help them when their internal coaching capability is not yet fully developed.</p> <p>External coaches have the advantage of experience, but the disadvantage of weak relationships in the client organization. Internal coaches, on the other hand, have strong relationships in their organization, but may lack the breadth of experience that would make them highly effective.</p>

“I-SHAPED PEOPLE AND T-SHAPED PEOPLE”

Some people have deep specializations in one domain, but rarely contribute outside of that domain. These people are known in agile communities as “I-shaped people” since, like the letter “I,” they have depth, but not much breadth. By contrast “T-shaped people” supplement their expertise in one area with supporting, but less-developed skills in associated areas and good collaboration skills. As an example, a person who can test some areas of the product and develop different areas of the product is considered to be a T-shaped person.

A T-shaped person has a defined, recognized specialization and primary role, but has the skills, versatility, and aptitude for collaboration to help other people when and where necessary. This collaboration reduces hand-offs and the constraints of only one person being able to do the job.

4.3.3 GENERALIZING SPECIALISTS

Agile teams are cross-functional, but the people often do not start off that way. However, many successful agile teams are made up of generalizing specialists, or “T-shaped” people.

This means team members have both a focus specialty plus a breadth of experience across multiple skills, rather than a single specialization. Agile team members work to develop such characteristics due to intense collaboration and self-organization to swarm and get work done quickly, which requires them to routinely help each other.

A single person’s throughput is not relevant. Focusing on a single person’s throughput may even be harmful if it creates a bottleneck for the rest of the team. The goal is for the *team* to optimize the delivery of finished work to get feedback.

If the customer desires great results, such as rapid feature delivery with excellent quality, the team cannot be structured just with specialist roles in an attempt to maximize resource efficiency. The team’s objective is flow efficiency, optimizing the throughput of the entire team. Small batch sizes promote working together as a team. The product owner’s job is to make sure the team works on the highest-value work.

4.3.4 TEAM STRUCTURES

Teams have adopted agile principles and practices across many industries. They organize people into cross-functional teams to iteratively develop working products.

CASE

The core team assembled to write this practice guide had varied backgrounds—some represented PMI and some represented Agile Alliance. They were self-organizing and worked in increments to complete the work. PMI assembled a group of subject matter experts to inspect the work, and this allowed the team to incorporate feedback and improve the product as it was developed. However the core team was not representative of a typical agile team because its members' time was not 100% dedicated to this endeavor.

Some organizations have been able to create colocated, cross-functional teams; others have a different situation. Instead of having all team members colocated, some organizations have distributed or dispersed teams. Distributed teams have cross-functional teams in different locations. Dispersed teams may have each team member working in a completely different location, either in an office or from home. While these arrangements are not ideal due to increased communication costs, they may still be workable.

In one large, U.S.-based financial institution there was a program with a set of teams where the team members were based on the East Coast of the United States and several locations throughout India. When the team first started, it was one large dispersed team (UX, analysts, developers, and testers) doing a “follow the sun”² development practice where some working time overlapped across the team members to do warm hand-offs with the work. Team members conducted daily standups together and used webcams to include all team members. Key roles (analysts, product owners, UX designers, and development leads) in the U.S. would come in early to answer any questions from their India-based team members and help to resolve impediments.

As the product started getting larger, and more funding came through, they decided to break into five smaller teams. To do this, they decided to build colocated, distributed teams in various locations. They made the decision to build cross-functional, colocated teams in each of these locations consisting of developers and testers.

They also had a core set of analysts, based in the two U.S. locations, who worked with their U.S.-based product manager and product owners and then worked with each of the teams, respectively. Although they had some structure in place where they conducted product reviews as an entire program, most of the other activities were conducted at a team level, based on what worked best for each team, to allow them to self-organize.

4.3.5 DEDICATED TEAM MEMBERS

What happens when the team members’ time is not 100% dedicated to the team? While this condition is not ideal, unfortunately, it sometimes cannot be avoided.

The key problem with having someone invest only a capacity of 25% or 50% on the team is that they will multitask and task switch. Multitasking reduces the throughput of the team’s work and impacts the team’s ability to predict delivery consistently.

TIP

Multitasking slows the progress of the entire team, because team members waste time context switching and/or waiting for each other to finish other work. When people are 100% dedicated to the team, the team has the fastest possible throughput.

² A follow-the-sun development process is one where work is handed off at the end of every day from one site to the next, many time zones away in order to speed up product development.

People experience productivity losses somewhere between 20% and 40% when task switching. The loss increases exponentially with the number of tasks.

When a person multitasks between two projects, that person is not 50% on each project. Instead, due to the cost of task switching, the person is somewhere between 20% and 40% on each project.

People are more likely to make mistakes when they multitask. Task-switching consumes working memory and people are less likely to remember their context when they multitask.

When everyone on the team is 100% allocated to one project, they can continuously collaborate as a team, making everyone's work more effective.

CASE



Since core team members developing this practice guide cannot dedicate 100% of their capacity to the team's efforts, their throughput is substantially lower than what it might be if they could afford to collocate and invest their attention full-time to the project. However, while it is economically viable to collaborate, even if dispersed and operating at a fraction of their full capacity, it is not feasible to collocate and focus at full capacity. Therefore, the team identified their dispersion as a potential risk. The team tracks and monitors the progress of their work through the use of collaborative tools and adjusts assignments based on individual capacity accordingly.



See Table A1-2 on Project Management Process Group and Knowledge Area Mapping for more tips on teams in agile environments, specifically the processes in the Project Resource Management Knowledge Area.

TIP

Not all teams have all the roles that they need. For example, some teams need support from database administrators or research analysts. When a team has temporarily assigned specialists, it is important to ensure that everyone has the same set of expectations. Is this specialist 100% allocated to the team and for how long? Set expectations with everyone (the specialist and the team) to clarify the level of commitment so the team can deliver. Part-time assignments create risks for the project.

4.3.6 TEAM WORKSPACES

Teams need a space in which they can work together, to understand their state as a team, and to collaborate. Some agile teams all work in one room together. Some teams have a team workspace for their standups and charts, and work on their own in cubicles or offices.

While companies are moving toward open, collaborative work environments, organizations also need to create quiet spaces for workers who need uninterrupted time to think and work. Therefore, companies are designing their offices to balance common and social areas (sometimes called “caves and common”) with quiet areas or private spaces where individuals can work without being interrupted.

When teams have geographically distributed members, the team decides how much of their workplace is virtual and how much is physical. Technology such as document sharing, video conferencing, and other virtual collaboration tools help people collaborate remotely.

Geographically distributed teams need virtual workspaces. In addition, consider getting the team together in person at regular intervals so the team can build trust and learn how to work together.

Some techniques to consider for managing communication in dispersed teams are *fishbowl windows* and *remote pairing*:

- ◆ Create a fishbowl window by setting up long-lived video conferencing links between the various locations in which the team is dispersed. People start the link at the beginning of a workday, and close it at the end. In this way, people can see and engage spontaneously with each other, reducing the collaboration lag otherwise inherent in the geographical separation.
- ◆ Set up remote pairing by using virtual conferencing tools to share screens, including voice and video links. As long as the time zone differences are accounted for, this may prove almost as effective as face-to-face pairing.

TIP

Form teams by bringing people with different skills from different functions together. Educate managers and leaders about the agile mindset and engage them early in the agile transformation.

4.3.7 OVERCOMING ORGANIZATIONAL SILOS

The best place to start when forming agile teams is by building a foundational trust and a safe work environment to ensure that all team members have an equal voice and can be heard and considered. This, along with building the agile mindset is the underlying success factor—all other challenges and risks can be mitigated.

Often, siloed organizations create impediments for forming cross-functional agile teams. The team members needed to build the cross-functional teams typically report to different managers and have different metrics by which managers measure their performance. Managers need to focus on flow efficiency (and team-based metrics) rather than resource efficiency.

To overcome organizational silos, work with the various managers of these team members and have them dedicate the necessary individuals to the cross-functional team. This not only creates team synergy but also allows the organization to see how leveraging its people will optimize the project or product being built.

For more information about teams see Appendix X2 on Attributes that Influence Tailoring.



TIP

As an agile project leader, first focus on how you can create a team that is cross-functional and 100% dedicated to one team. Even if it means just getting key team members, such as the developers and testers, to work and communicate together on a daily basis, that is a step in the right direction toward agility.



5

IMPLEMENTING AGILE: DELIVERING IN AN AGILE ENVIRONMENT

5.1 CHARTER THE PROJECT AND THE TEAM

Every project needs a project charter so the project team knows why this project matters, where the team is headed and what the project objective is. However, the project charter itself may not be enough for the team. Agile teams require team norms and an understanding of how to work together. In that case, the team might need a team charter.

The chartering process helps the team learn how to work together and coalesce around the project.

At a minimum, for an agile project, the team needs the project vision or purpose and a clear set of working agreements. An agile project charter answers these questions:

- ◆ Why are we doing this project? This is the project vision.
- ◆ Who benefits and how? This may be part of the project vision and/or project purpose.
- ◆ What does done mean for the project? These are the project's release criteria.
- ◆ How are we going to work together? This explains the intended flow of work.

A servant leader may facilitate the chartering process. A team can coalesce by working together, and the project charter is a great way to start working. In addition, team members may want to collaborate to understand how they will work together.



Teams do not need a formal process for chartering as long as the teams understand how to work together. Some teams benefit from a team chartering process. Here are some chartering ideas for team members to use as a basis for their social contract:

- ◆ Team values, such as sustainable pace and core hours;
- ◆ Working agreements, such as what “ready” means so the team can take in work; what “done” means so the team can judge completeness consistently; respecting the timebox; or the use of work-in-process limits;
- ◆ Ground rules, such as one person talking in a meeting; and
- ◆ Group norms, such as how the team treats meeting times.

The servant leader together with the team may decide to address other behaviors.

Remember that the team’s social contract—its team charter—is how the team members interact with each other. The goal of the team charter is to create an agile environment in which team members can work to the best of their ability as a team.

5.2 COMMON AGILE PRACTICES

Sections 5.2.1 through 5.2.8 describe a few of the most common agile project practices.

5.2.1 RETROSPECTIVES

The single most important practice is the retrospective because it allows the team to learn about, improve, and adapt its process.

Retrospectives help the team learn from its previous work on the product and its process. One of the principles behind the Agile Manifesto is: “At regular intervals, the team reflects on how to become more effective, then tunes and adjusts its behavior accordingly.”

Many teams use iterations—especially 2-week iterations—because the iteration prompts a demonstration and a retrospective at the end. However, the team does not need iterations in order to retrospect. Team members may decide to retrospect at these key times:

- ◆ When the team completes a release or ships something. It does not have to be a monumental increment. It can be any release, no matter how small.
- ◆ When more than a few weeks have passed since the previous retrospective.
- ◆ When the team appears to be stuck and completed work is not flowing through the team.
- ◆ When the team reaches any other milestone.

Teams benefit from allocating enough time to learn, either from an interim retrospective or an end-of-the-project retrospective. Teams need to learn about their work product and work process. For example, some teams have trouble finishing work. When teams plan enough time, they can structure their retrospective to gather data, process that data, and decide what to try later as an experiment.

First and foremost, a retrospective is not about blame; the retrospective is a time for the team to learn from previous work and make small improvements.

The retrospective is about looking at the qualitative (people's feelings) and quantitative (measurements) data, then using that data to find root causes, designing countermeasures, and developing action plans. The project team may end up with many action items to remove impediments.

Consider limiting the number of action items to the team's capacity to address improvement in the upcoming iteration or work period. Trying to improve too many things at once and not finishing any of them is much worse than planning to complete fewer items and successfully completing all of them. Then, when time allows, the team can work on the next improvement opportunity on the list. When the team selects the improvements, decide how to measure the outcomes. Then, in the next time period, measure the outcomes to validate success or failure of each improvement.

A facilitator from the team leads them through an activity to rank the importance of each improvement item. Once the improvement items are ranked by the team, the team chooses the appropriate number to work on for the next iteration (or adds work to the flow if flow-based).

5.2.2 BACKLOG PREPARATION

The backlog is the ordered list of all the work, presented in story form, for a team. There is no need to create all of the stories for the entire project before the work starts—only enough to understand the first release in broad brushstrokes and then sufficient items for the next iteration.

Product owners (or a product owner value team that includes the product manager and all relevant product owners for that area of the product,) might produce a product roadmap to show the anticipated sequence of deliverables over time. The product owner replans the roadmap based on what the team produces. (See Appendix X3 on Agile Suitability Filter Tools for examples of roadmaps.)

5.2.3 BACKLOG REFINEMENT

In iteration-based agile, the product owner often works with the team to prepare some stories for the upcoming iteration during one or more sessions in the middle of the iteration. The purpose of these meetings is to refine enough stories so the team understands what the stories are and how large the stories are in relation to each other.

There is no consensus on how long the refinement should be. There is a continuum of:

- ◆ Just-in-time refinement for flow-based agile. The team takes the next card off the to-do column and discusses it.
- ◆ Many iteration-based agile teams use a timeboxed 1-hour discussion midway through a 2-week iteration. (The team selects an iteration duration that provides them frequent-enough feedback.)
- ◆ Multiple refinement discussions for iteration-based agile teams. Teams can use this when they are new to the product, the product area, or the problem domain.

TIP

Consider using impact mapping to see how the product fits together. Under normal circumstances, the product owner leads this work. A servant leader can facilitate any necessary meetings as a way of serving the project.

Refinement meetings allow the product owner to present story ideas to the team and for the team to learn about the potential challenges or problems in the stories. If the product owner is unsure of the dependencies, the product owner can request the team to spike the feature in order to understand the risks.

There are many ways for the product owner to conduct backlog preparation and refinement meetings, including for example:

- ◆ Encourage the team to work as triads of developer, tester, business analyst/product owner to discuss and write the story.
- ◆ Present the overall story concept to the team. The team discusses and refines it into as many stories as required.
- ◆ Work with the team to find various ways to explore and write the stories together, making sure all of the stories are small enough so the team can produce a steady flow of completed work. Consider becoming able to complete a story at least once a day.

Teams often have a goal of spending not more than 1 hour per week refining stories for the next batch of work. Teams want to maximize the time spent doing work as opposed to planning work. If the team needs to spend more than 1 hour per week refining stories, the product owner could be overpreparing, or the team may be lacking some critical skills needed to evaluate and refine the work.

5.2.4 DAILY STANDUPS

Teams use standups to microcommit to each other, uncover problems, and ensure the work flows smoothly through the team.

Timebox the standup to no longer than 15 minutes. The team “walks” the Kanban or task board in some way, and anyone from the team can facilitate the standup.

In iteration-based agile, everyone answers the following questions in a round-robin fashion:

- ◆ What did I complete since the last standup?
- ◆ What am I planning to complete between now and the next standup?
- ◆ What are my impediments (or risks or problems)?

Questions like these generate answers that allow the team to self-organize and hold each other accountable for completing the work they committed to the day before and throughout the iteration.

Flow-based agile has a different approach to standups, focusing on the team's throughput. The team assesses the board from right to left. The questions are:

- ◆ What do we need to do to advance this piece of work?
- ◆ Is anyone working on anything that is not on the board?
- ◆ What do we need to finish as a team?
- ◆ Are there any bottlenecks or blockers to the flow of work?

One of the antipatterns typically seen in standups is they become status meetings. Teams who have traditionally worked in a predictive environment may tend to fall into this antipattern since they are used to providing a status.

Another antipattern typically seen in standups is that the team begins to solve problems as they become apparent. Standups are for realizing there are problems—not for solving them. Add the issues to a parking lot, and then create another meeting, which might be right after the standup, and solve problems there.

Teams run their own standups. When run well, standups can be very useful, provided the nature of the team's work requires intense collaboration. Make a conscious decision about when the team needs, or can effectively use, standups.

TIP

Encourage any team member to facilitate the standup instead of a project manager or leader to ensure it does not turn into a status meeting, but instead is used as a time for the team to self-organize and make commitments to each other.

5.2.5 DEMONSTRATIONS/REVIEWS

As the team completes the features usually in the form of user stories, the team periodically demonstrates the working product. The product owner sees the demonstration and accepts or declines stories.

In iteration-based agile, the team demonstrates all completed work items at the end of the iteration. In flow-based agile, the team demonstrates completed work when it is time to do so, usually when enough features have accumulated into a set that is coherent. Teams, including the product owner, need feedback to decide how early to ask for product feedback.

As a general guideline, demonstrate whatever the team has as a working product at least once every 2 weeks. That frequency is enough for most teams, so team members can get feedback that prevents them from heading in a wrong direction. That is also frequent enough so that the teams can keep the product development clean enough to build a complete product as often as they want or need to.

A fundamental part of what makes a project agile is the frequent delivery of a working product. A team that does not demonstrate or release cannot learn fast enough and is likely not adopting agile techniques. The team may require additional coaching to enable frequent delivery.

5.2.6 PLANNING FOR ITERATION-BASED AGILE

Each team's capacity is different. Each product owner's typical story size is different. Teams consider their story size so they do not try to commit to more stories than there is team capacity to complete within one iteration.

When people are unavailable (e.g., holidays, vacations, or anything that prevents people from participating in the next set of work), the product owner understands that the team has reduced capacity. The team will not be able to finish the same amount of work as it finished in the previous time period. When teams have a reduced capacity, they will only plan for work that meets that capacity.

Teams estimate what they can complete, which is a measure of capacity (see Section 4.10 for examples). Teams cannot predict with 100% certainty what they can deliver, as they cannot know the unexpected. When product owners make the stories smaller and teams see progress in the form of a finished product, teams learn what they are able to do for the future.

Agile teams do not plan just once in one single chunk. Instead, agile teams plan a little, deliver, learn, and then replan a little more in an ongoing cycle.

TIP

Draw the team's attention to the antipattern and help the team to discover how to improve its standups.

5.2.7 EXECUTION PRACTICES THAT HELP TEAMS DELIVER VALUE

If the team does not pay attention to quality, it will soon become impossible to release anything rapidly.

The following technical practices, many of which come from eXtreme Programming, may help the team to deliver at their maximum speed:

- ◆ **Continuous integration.** Perform frequent incorporation of work into the whole, no matter the product, and then retest to determine that the entire product still works as intended.
- ◆ **Test at all levels.** Employ system-level testing for end-to-end information and unit testing for the building blocks. In between, understand if there is a need for integration testing and where. Teams find smoke testing helpful as a first look at whether the work product is any good. Teams have found that deciding when to run regression tests and which ones helps them maintain product quality with good build performance. Agile teams have a strong preference for automated tests so they can build and maintain a momentum of delivery.
- ◆ **Acceptance Test-Driven Development (ATDD).** In ATDD, the entire team gets together and discusses the acceptance criteria for a work product. Then the team creates the tests, which allows the team to write just enough code and automated tests to meet the criteria. For non-software projects, consider how to test the work as the team completes chunks of value.
- ◆ **Test-Driven Development (TDD) and Behavior-Driven Development (BDD).** Writing automated tests before writing/creating the product actually helps people design and mistake-proof the product. For non-software projects, consider how to “test-drive” the team’s designs. Hardware and mechanical projects often use simulations for interim tests of their designs.
- ◆ **Spikes (timeboxed research or experiments).** Spikes are useful for learning and may be used in circumstances such as: estimation, acceptance criteria definition, and understanding the flow of a user’s action through the product. Spikes are helpful when the team needs to learn some critical technical or functional element.

5.2.8 HOW ITERATIONS AND INCREMENTS HELP DELIVER WORKING PRODUCT

Iterations help a team create a cadence for delivery and many kinds of feedback. Teams produce increments of value for delivery and feedback. The first part of this delivery is a demonstration. Teams receive feedback about how the product looks and operates through a demo. Team members retrospect to see how they can inspect and adapt their process to succeed.

Demonstrations or reviews are a necessary part of the agile project flow. Schedule the demonstration as appropriate for the team's delivery cadence.

5.3 TROUBLESHOOTING AGILE PROJECT CHALLENGES

Agile approaches were born out of the need to solve issues associated with high rates of change, uncertainty, and complexity on projects. Due to these origins, they contain a variety of tools and techniques for dealing with issues that present problems in predictive approaches. Refer to Table 5-1.

TIP

Teams should demo often for feedback and to show progress. Encourage the PMO and other interested parties to watch demonstrations so the people deciding on the project portfolio can see the actual progress.

Table 5-1. Agile Pain Points and Troubleshooting Possibilities

Pain Point	Troubleshooting Possibilities
Unclear purpose or mission for the team	Agile chartering for purpose—vision, mission, and mission tests
Unclear working agreements for the team	Agile chartering for alignment—values, principles, and working agreements
Unclear team context	Agile chartering for context—boundaries, committed assets, and prospective analysis
Unclear requirements	Help sponsors and stakeholders craft a product vision. Consider building a product roadmap using specification by example, user story mapping, and impact mapping. Bring the team and product owner together to clarify the expectations and value of a requirement. Progressively decompose roadmap into backlog of smaller, concrete requirements.
Poor user experience	User experience design practices included in the development team involve users early and often.
Inaccurate estimation	Reduce story size by splitting stories. Use relative estimation with the entire team to estimate. Consider agile modeling or spiking to understand what the story is.
Unclear work assignments or work progress	Help the team learn that they self-manage their work. Consider kanban boards to see the flow of work. Consider a daily standup to walk the board and see what work is where.
Team struggles with obstacles	A servant leader can help clear these obstacles. If the team doesn't know the options they have, consider a coach. Sometimes, the team needs to escalate stories the team or servant leader has not been able to remove.
Work delays/overruns due to insufficiently refined product backlog items	Product owner and team workshop stories together. Create a definition of ready for the stories. Consider splitting stories to use smaller stories.
Defects	Consider the technical practices that work for the environment. Some possibilities are: pair work, collective product ownership, pervasive testing (test-driven and automated testing approaches) and a robust definition of done.
Work is not complete	Team defines definition of done for stories including acceptance criteria. Also add release criteria for projects.
Technical debt (degraded code quality)	Refactoring, agile modeling, pervasive testing, automated code quality analysis, definition of done

Table 5-1. Agile Pain Points and Troubleshooting Possibilities (cont.)

Pain Point	Troubleshooting Possibilities
Too much product complexity	For software and non-software encourage the team always to be thinking “What is the simplest thing that would work?” and apply the agile principle of “Simplicity--the art of maximizing the amount of work not done”. These help reduce complexity.
Slow or no improvement in the teamwork process	Capture no more than three items to improve at each retrospective. Ask the servant leader to help the team learn how to integrate those items.
Too much upfront work leading to rework	Instead of much upfront work, consider team spikes to learn. In addition, measure the WIP during the beginning of the project and see what the team’s options are to deliver value instead of designs. Shorten iterations and create a robust definition of done.
False starts, wasted efforts	Ask the product owner to become an integral part of the team.
Inefficiently ordered product backlog items	Rank with value including cost of delay divided by duration (CD3) and other value models
Rush/wait uneven flow of work	Plan to the team’s capacity and not more. Ask people to stop multitasking and be dedicated to one team. Ask the team to work as pairs, a swarm, or mob to even out the capabilities across the entire team.
Impossible stakeholder demands	Servant leadership to work with this stakeholder (and possibly product owner).
Unexpected or unforeseen delays	Ask the team to check in more often, use kanban boards to see the flow of work and work in progress limits to understand the impact of the demands on the team or product. Also track impediments and impediment removal on an impediment board.
Siloed teams, instead of cross-functional teams	Ask the people who are part of projects to self-organize as cross-functional teams. Use servant leadership skills to help the managers understand why agile needs cross-functional teams.



5.4 MEASUREMENTS IN AGILE PROJECTS

Transitioning to agile means using different measurements. Using agile means looking at new metrics that matter to the team and to management. These metrics matter because they focus on customer value.

One problem with status reporting is the team's ability to predict completion or to use traffic light status to describe the project. For instance, project leaders describe the project as "90% done." At that point the team tries to integrate the pieces into a product. The team discovers missing requirements or surprises, or finds that the product doesn't integrate the way they thought it would.

The project is only partway done, and the traffic light status reporting does not reflect the real state. Too often, the project team realizes it will need just as much time to complete the remainder of the project. For too many projects, the team realizes they are—at most—10% done because of issues the team discovered.

The problem with predictive measurements is that they often do not reflect reality. It often happens that a project status light is green up until 1 month before the release date; this is sometimes referred to as a watermelon project (green on the outside, red on the inside). Oftentimes project status lights turn red with seemingly no warnings, because there is no empirical data about the project until 1 month before the release date.

Metrics for agile projects contain meaningful information that provide a historical track record, because agile projects deliver value (finished work) on a regular basis. Project teams can use such data for improved forecasts and decision making.

Surrogate measurements such as percent done are less useful than empirical measurements such as finished features. See Section 4.10 for more information on value management. Agile helps teams see problems and issues so the team can diagnose and address them.

In addition to quantitative measures, the team can consider collecting qualitative measures. Some of these qualitative measures focus on practices the team has chosen and assess how well the team uses those practices, for example, the business satisfaction with delivered features, the morale of the team; and anything else the team wants to track as a qualitative measure.



5.4.1 AGILE TEAMS MEASURE RESULTS

Agile favors empirical and value-based measurements instead of predictive measurements. Agile measures what the team delivers, not what the team predicts it will deliver.

A team that is accustomed to having project baselines and estimates of earned value and ROI might be puzzled about working on a project and not managing to a baseline. Agile is based on working products of demonstrable value to customers.

Baselines are often an artifact of attempted prediction. In agile, the team limits its estimation to the next few weeks at most. In agile, if there is low variability in the team's work and if the team members are not multitasking, the team's capacity can become stable. This allows better prediction for the next couple of weeks.

After the team completes work in iteration or flow, the team can replan. Agile does not create the ability to do more work. However, there is evidence that the smaller the chunk of work, the more likely people are to deliver it.

Software product development, like other knowledge work, is about learning—learning while delivering value. Hardware development and mechanical development are similar in the design parts of the project. Learning takes place by experimenting, delivering small increments of value, and getting feedback on what has been accomplished thus far. Many other product development projects incorporate learning also.

Sponsors usually want to know when the project will be done. Once the team establishes a reliable velocity (average stories or story points per iteration) or the average cycle time, the team can predict how much longer the project will take.

As an example, if the team averages 50 story points per iteration, and the team estimates there are about another 500 points remaining, the team estimates it has about 10 iterations remaining. As the product owner refines the stories remaining and as the team refines its estimates, the project estimate could go up or down, but the team can provide an estimate.

If the team averages a cycle time of three days per story and there are 30 remaining stories, the team would have 90 business days remaining, approximately 4 to 5 months.

Reflect the estimate variability with hurricane-style charts, or some other variability measure that the sponsors will understand.



Because learning is such a large part of the project, the team needs to balance uncertainty and provide value to the customers. The team plans the next small part of the project. The team reports empirical data and replans further small increments to manage the project uncertainty.

Some iteration-based projects use burndown charts to see where the project is going over time. Figure 5-1 shows an example of a burndown chart where the team planned to deliver 37 story points. Story points rate the relative work, risk, and complexity of a requirement or story. Many agile teams use story points to estimate effort. The dotted burndown line is the plan. In Figure 5-1, the team can see by Day 3 that they are at risk for that delivery.

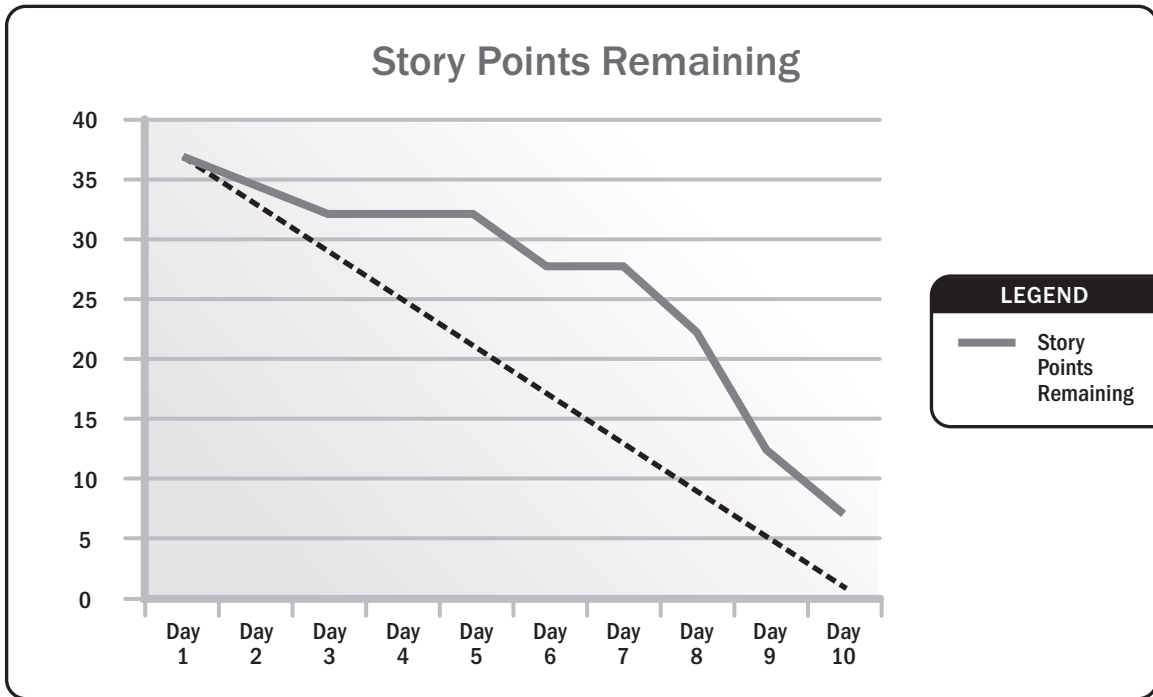

Figure 5-1. Burndown Chart for Remaining Story Points

Some project teams prefer burnup charts. The same data used in Figure 5-1 is shown in Figure 5-2 in a burnup chart.

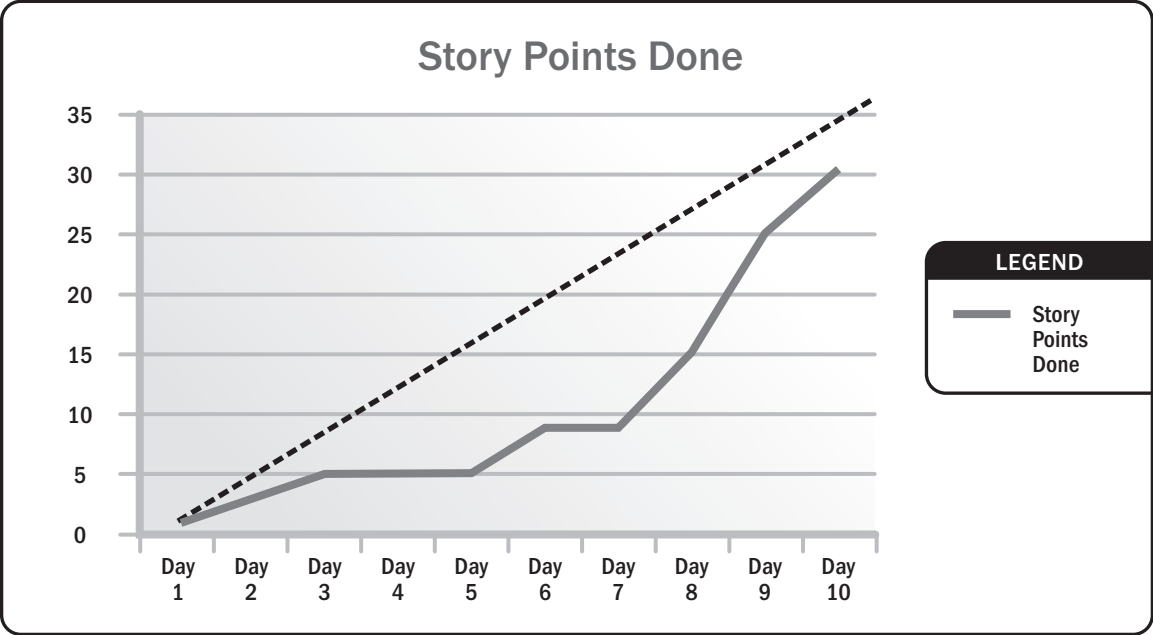

Figure 5-2. Burnup Chart for Showing Story Points Completed

Burnup charts show the work completed. The two charts in Figures 5-1 and 5-2 are based on the same data, but displayed in two different ways. Teams may prefer how to see their data.

When a team sees what it has not yet completed as it works through an iteration, the team may become dispirited and possibly rush to complete the work without meeting the acceptance criteria. However, the team could have any number of good reasons for not completing work as it expected. Burndowns show the effect of team members multitasking, stories that are too large, or team members out of the office.



Especially with teams new to agile, the burnup will show changes in scope during the iteration. Burnups allow teams to see what they have accomplished, which helps the team proceed to the next piece of work.

Whether teams use burndown or burnup charts, they see what they have completed as the iteration progresses. At the end of the iteration, they might base their next measure of capacity (how many stories or story points) on what they completed in this iteration. That allows the product owner along with the team to replan what the team is more likely to succeed in delivering in the next iteration.

Velocity, the sum of the story point sizes for the features actually completed in this iteration, allows the team to plan its next capacity more accurately by looking at its historical performance.

Flow-based agile teams use different measurements: lead time (the total time it takes to deliver an item, measured from the time it is added to the board to the moment it is completed), cycle time (the time required to process an item), and response time (the time that an item waits until work starts). Teams measure cycle time to see bottlenecks and delays, not necessarily inside the team.



TIP

Teams might discover it can take four to eight iterations to achieve a stable velocity. The teams need the feedback from each iteration to learn about how they work and how to improve.

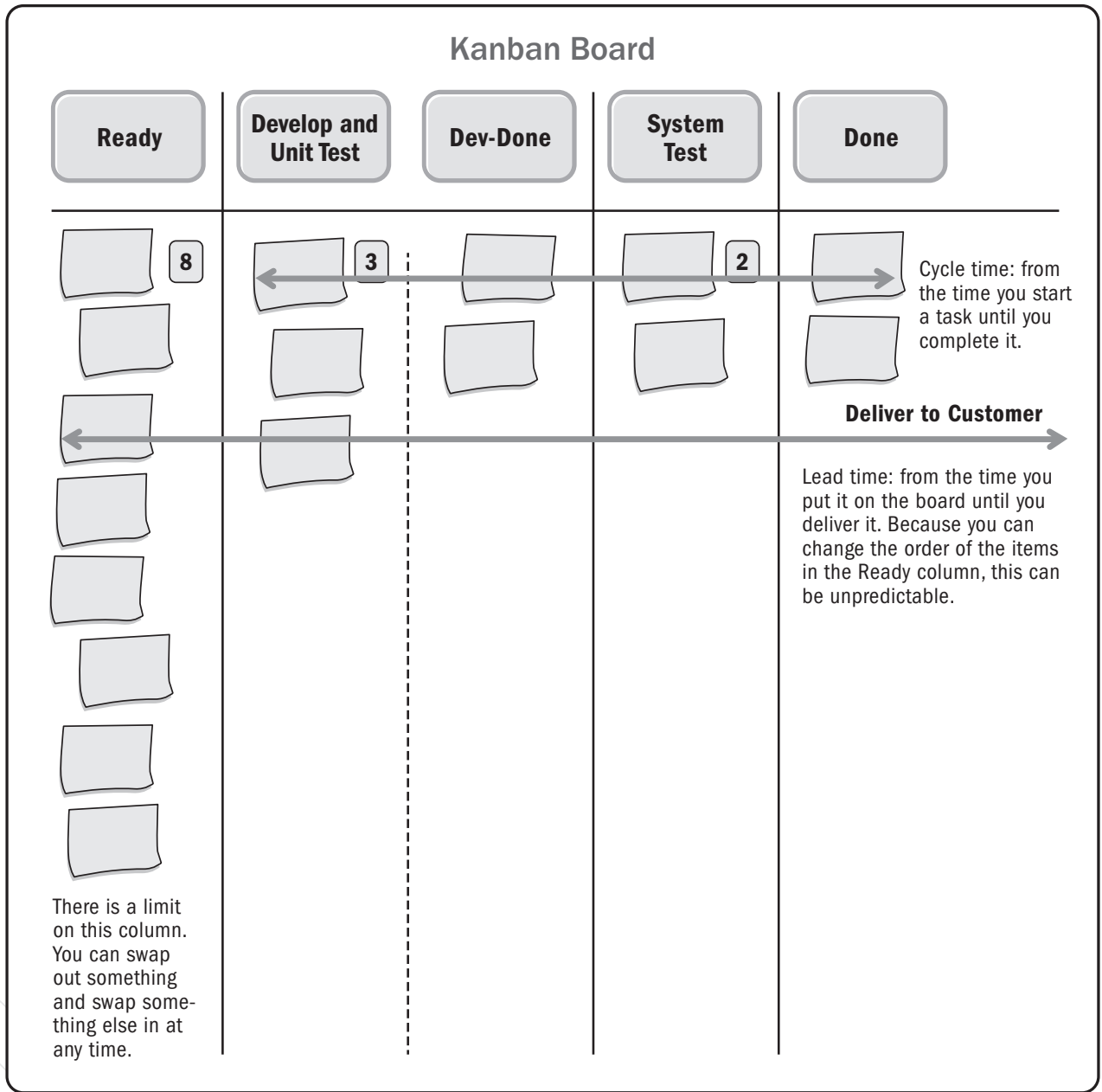

Figure 5-3. Example of a Kanban Board

Lead time is useful to understand cycle time from the first look at a particular feature to the length of time it took to release it to the customer. The work in progress (WIP) limits at the top of each column, shown in boxes here, allows the team to see how to pull work across the board. When the team has met its WIP limits, the team cannot pull work from the left into the next column. Instead, the team works from the right-most full column and asks, “What do we do as a team to move this work into the next column?”

Each feature is unique, so its cycle time is unique. However, a product owner might notice that smaller features have smaller cycle times. The product owner wants to see throughput, so the product owner creates smaller features or works with the team to do so.

Burnups, burndowns (capacity measures) and lead time, and cycle time (predictability measures) are useful for in-the-moment measurements. They help a team understand how much more work they have and whether the team might finish on time.

Measuring story points is not the same as measuring completed stories or features. Some teams attempt to measure story points without completing the actual feature or story. When teams measure only story points, they measure capacity, not finished work, which violates the principle of “the primary measure of progress is working software” (or, other product if not software).

Each team has its own capacity. When a team uses story points, be aware that the number of story points a team can complete in a given time is unique to that team.

TIP

When teams depend on external people or groups, measure cycle time to see how long it takes for the team to complete the work. Measure lead time to see the external dependencies after the team completes its work. Teams can also measure the reaction time, the time from ready to the first column, to see how long it takes them—on average—to respond to new requests.

When teams provide their own units of measure, teams are better able to assess and estimate and deliver their work. The downside of relative estimation is that there is no way to compare teams or add velocity across teams.

The team can measure completed work in a feature burnup/burndown chart and in a product backlog burnup chart. These charts provide trends of completion over time, as shown in Figure 5-4.

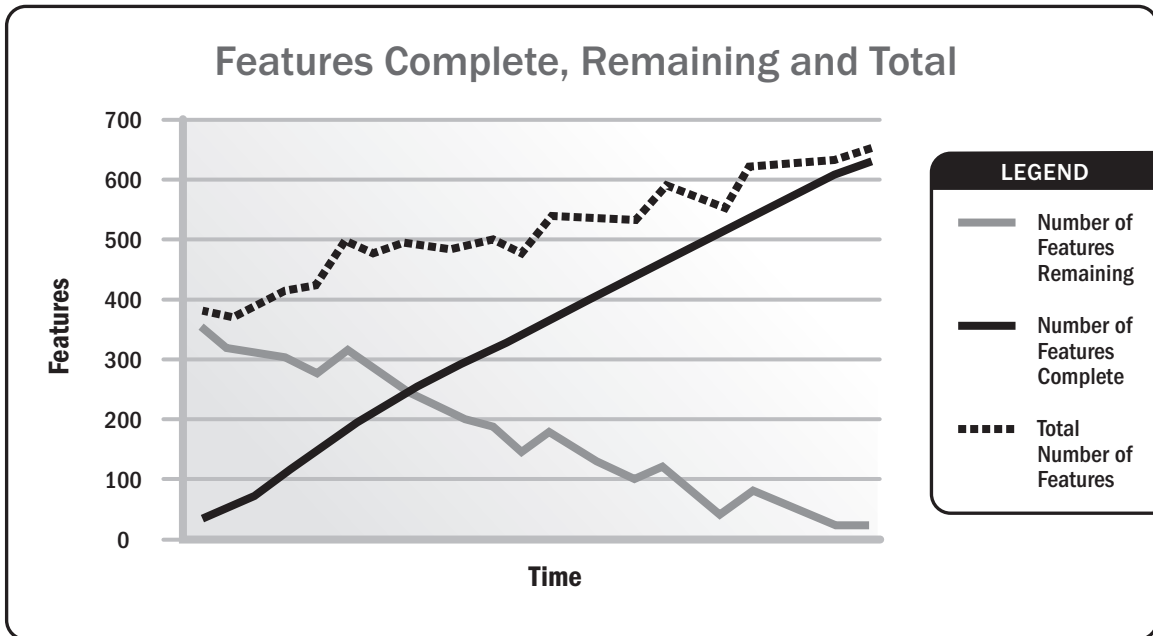

Figure 5-4. Feature Chart

Feature burnup/burndown charts may show that requirements grew during the project. The features complete line shows that the team completes features at a regular pace. The total features line shows how the project's total features changed over time. The features remaining burndown line shows that the rate of feature completion varies. Every time features are added to the project, the burndown line changes.

Earned value in agile is based on finished features, as shown in Figure 5-5. The product backlog burnup chart shows completed work compared to total expected work at interval milestones or iterations.

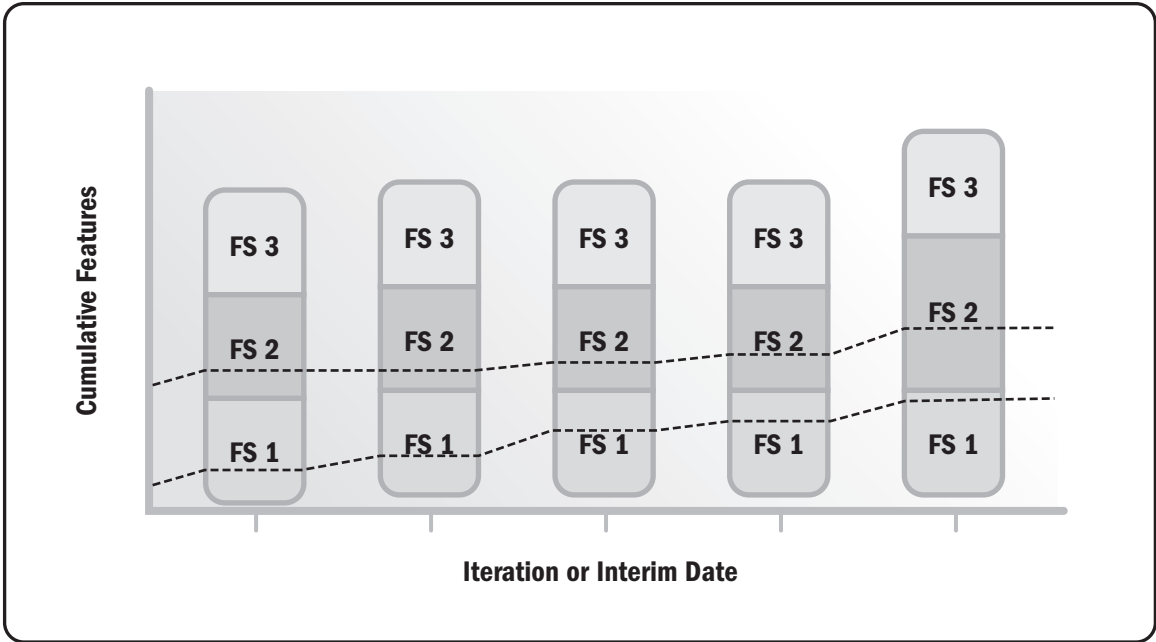

Figure 5-5. Product Backlog Burnup Chart

A team can only finish one story at a time. To complete a large feature that contains several stories, the team will have remaining stories to complete and may not complete that entire feature until several more time periods have passed. The team can show its completed value with a product backlog burnup chart as shown in Figure 5-5.

If a team needs to measure earned value, it can consider using this burnup chart in Figure 5-6 as an example: Note that the left Y axis represents story points as scope, and the right Y axis represents the project spend.

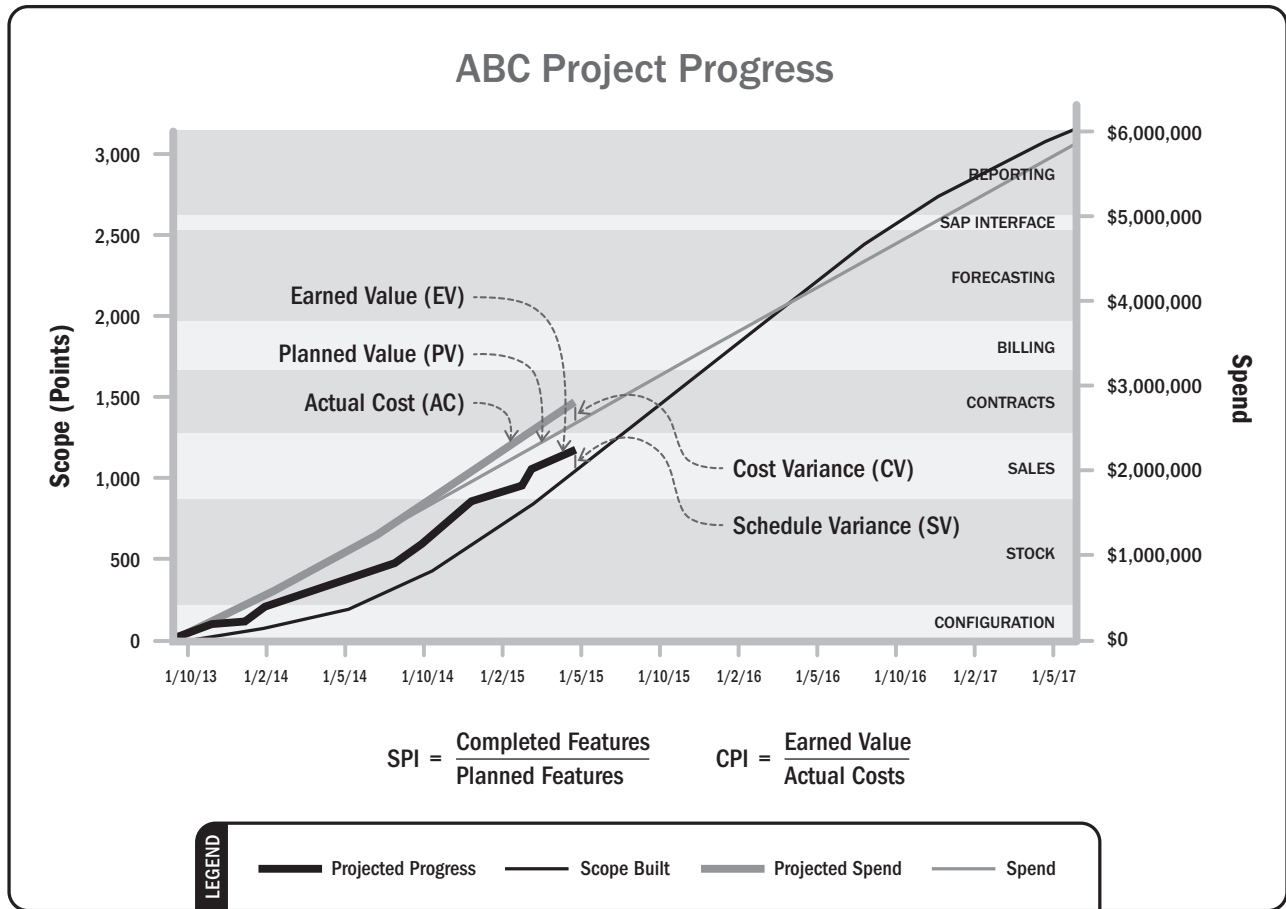

Figure 5-6. Earned Value in an Agile Context

Traditional EVM metrics like schedule performance index (SPI) and cost performance index (CPI) can be easily translated into agile terms. For example, if the team planned to complete 30 story points in an iteration, but only completed 25 then the SPI is 25/30 or 0.83 (the team is working at only 83% of the rate planned). Likewise, CPI is the earned value (completed features value) to date divided by the actual costs to date or, as shown in Figure 5-6, \$2.2M / \$2.8M = 0.79. This means a result of only 79 cents on the dollar compared to plan (but of course this assumes that the prediction is still correct).

A cumulative flow diagram, illustrated in Figure 5-7, shows the work in progress across a board. If a team has many stories waiting for test, the testing band will swell. Work accumulation can be seen at a glance.

Teams have trouble with accumulating work: the team has work in progress instead of work completed. When teams have a lot of work in progress, they delay their overall feature delivery. The longer it takes for a team to deliver, the more pressure a team will have for yet more features in the same period of time.

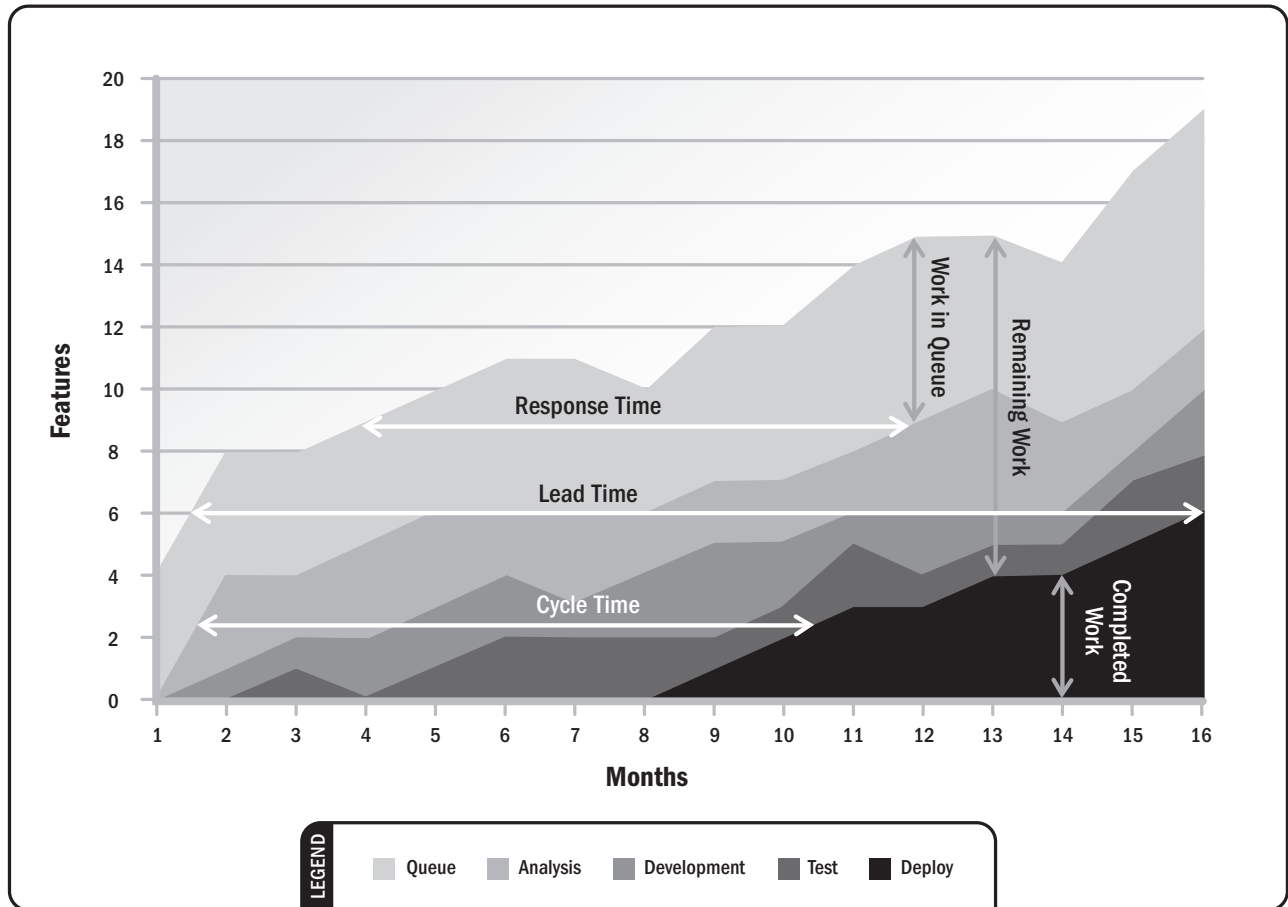

Figure 5-7. Cumulative Flow Diagram of Completed Features

Adapt this cumulative flow to the project task board.

6

ORGANIZATIONAL CONSIDERATIONS FOR PROJECT AGILITY

Every project exists in an organizational context. Cultures, structures, and policies can influence both the direction and the outcome of any project. These dynamics can challenge project leaders.

While project leaders may not have the ability to change organizational dynamics as they see fit, they are expected to navigate those dynamics skillfully.

This section explores the way the organization and in some circumstances, the project context, influences projects. Leaders can explore options for change, to increase project success.

Project agility is more effective and sustained as the organization adjusts to support it.

6.1 ORGANIZATIONAL CHANGE MANAGEMENT

Organizational change management covers the skills and techniques for influencing changes that support agility.

The PMI publication, *Managing Change in Organizations: A Practice Guide* [2], describes a comprehensive and holistic approach for successfully introducing meaningful change. The recommendations offered there include:

- ◆ Models for describing change dynamics,
- ◆ Framework for achieving change, and
- ◆ Application of change management practices at the project, program, and portfolio levels.

Sections 6.1.1 and 6.1.2 explore the considerations of change management specific to an agile context.

Figure 6-1 shows the relationship between these two topics.

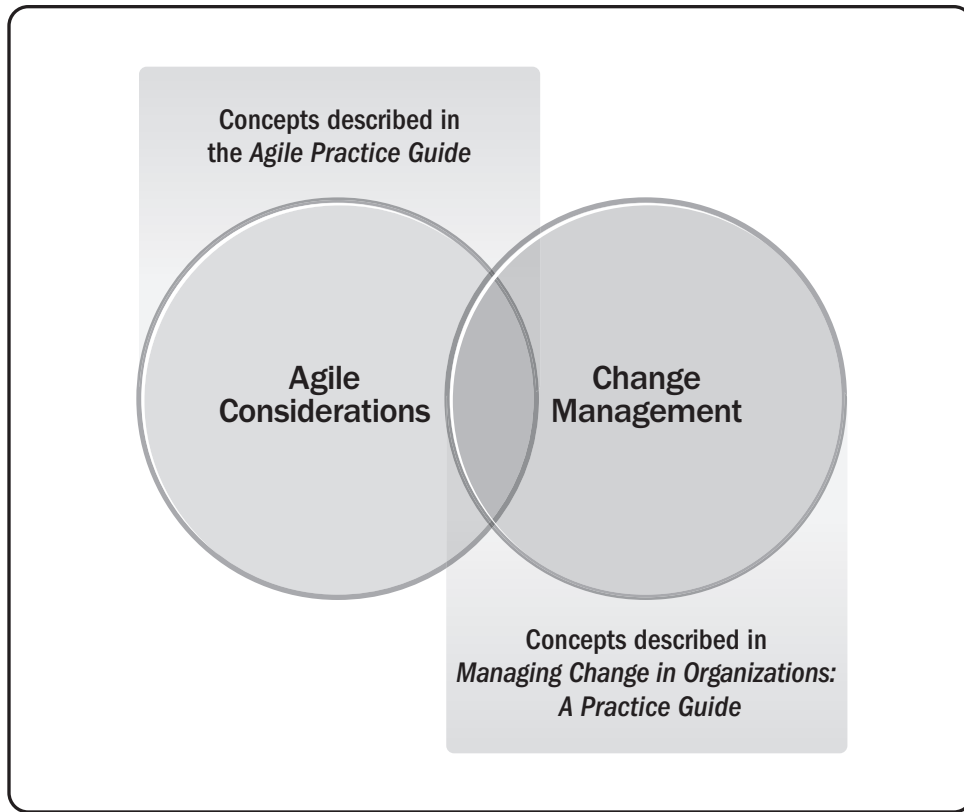

Figure 6-1. The Relationship Between Change Management and Agile Approaches

6.1.1 DRIVERS FOR CHANGE MANAGEMENT

All projects are about change. However, there are two key factors that further motivate the use of change management practices in an agile context:

- ◆ **Changes associated with accelerated delivery.** Agile approaches emphasize delivering project outputs early and often. However, the receiving organization may not be fully prepared to incorporate those outputs at an increased pace. Accelerating delivery will test the organization's ability to accommodate that delivery. Successfully discovering and delivering a project's features is not enough. If the organization resists the project's output, then the targeted return on investment is delayed. Customer acceptance of and alignment with project outputs becomes even more prevalent in an agile environment.
- ◆ **Changes associated with agile approaches.** Organizations just beginning to use agile approaches also experience high degrees of change. Higher degrees of collaboration may require more frequent handoffs between teams, departments, or vendors. Decomposing work into iterative prototypes involves rework that could be viewed negatively. Leaders should consider change management techniques to address the hurdles of transitioning to the use of agile approaches.

6.1.2 READINESS FOR CHANGE

Organizations beginning to use agile approaches should understand the relative compatibility of those methods with their current approaches. Some organizations will have characteristics that more easily support agile principles of cross-department collaboration, continuous learning, and evolving internal processes. Examples of these change-friendly characteristics include:

- ◆ Executive management's willingness to change;
- ◆ Organization's willingness to shift the way it views, reviews, and assesses employees;
- ◆ Centralization or decentralization of project, program, and portfolio management functions;
- ◆ Focus on short-term budgeting and metrics versus long-term goals; and
- ◆ Talent management maturity and capabilities.

Conversely, there are other institutional characteristics that may be roadblocks to achieving the changes associated with organizational agility. Examples of these include:

- ◆ Work is decomposed into departmental silos, creating dependencies that prevent accelerated delivery instead of building cross-functional teams with guidance from centers of competencies.
- ◆ Procurement strategies are based on short-term pricing strategies, rather than long-term competencies.
- ◆ Leaders are rewarded for local efficiencies rather than end-to-end flow of project delivery or optimizing the whole (in regard to the organization).
- ◆ Employees are specialized contributors with limited tools or incentives to diversify their skills instead of building T-shaped specialists.
- ◆ Decentralized portfolios pull employees simultaneously onto too many projects at once instead of keeping them focused on one project at a time.

The degree to which an organization is willing to review and modify these practices will determine how quickly and effectively agile approaches can be adopted. However, in response to these organizational impediments to agility, project leaders can try various approaches to accelerate a cultural compatibility for:

- ◆ Visible and active executive sponsorship,
- ◆ Change management practices, including communication and coaching,
- ◆ Progressively pacing the adoption of agile practices on a project-by-project basis
- ◆ Incremental introduction of agile practices to the team; and
- ◆ Leading by example by using agile techniques and practices where possible.

6.2 ORGANIZATIONAL CULTURE

An organization's culture is its DNA—its core identity. Culture will always influence the use of agile approaches. Organizational culture runs along a continuum, from highly predictive plans to lean startup where everything is an experiment. Although agile approaches fit well with the lean startup culture, a highly predictive organization can encourage empirical measurements, small experiments, and learning so they can move toward agility.

6.2.1 CREATING AN ENVIRONMENT OF SAFETY

Organizational culture is difficult to change, but the most important cultural norm in an organization willing to try any new method or technique is enabling a safe work environment.

Only in a safe, honest, and transparent environment can team members and leaders truly reflect on their successes to ensure their projects continue to advance, or apply lessons learned on failed projects so they do not fall back into the same patterns.

6.2.2 ASSESSING CULTURE

Every project finds itself in tension with competing aspirations. How can the team go fast without compromising quality? How can the team preserve flexibility while also hitting a firm date? Most importantly, how does the team satisfy and meet the requirements of the customer?

Project leaders may feel their job is to meet every expectation of every stakeholder; but, when compelled to make a choice, there is often a priority depending on the culture and requirements of the organization's business environment. For example, a mobile telecom project has a greater bias for speed, where a government program may have a greater bias for generalization and stability.

“Culture eats strategy for breakfast” —Peter Drucker

This statement stresses the importance of people's commitment and passion for a cause. No matter what strategy or plan you implement with your team, its success is going to be governed by the people implementing the plan. If the people who are driving the strategy aren't passionate about the change, or worse, are apathetic about their job and their organization, then you stand little chance of implementing the change.

To navigate these dynamics, project leaders should take the time to assess where emphasis is most often applied in the organization. Figure 6-2 illustrates what an assessment might look like. In this example, a project leader initiates a conversation about organizational priorities with stakeholders, team members, and senior management. Those priorities are then recorded as positions on a sliding scale between two extremes. The results are then used to find agile techniques that best fit with those priorities.

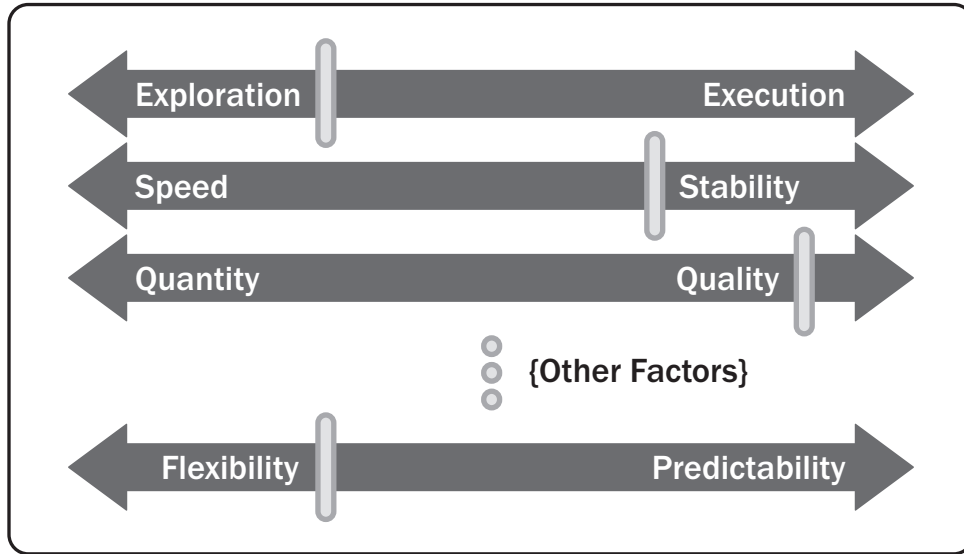

Figure 6-2. Example of Assessing Organizational Culture

Several models exist for assessing such dynamics; however, the model or method used is not that important. It is more critical that project leaders invest the effort to understand the forces that shape their context. Understanding the organization and the industry requirements that an organization needs to satisfy allows for choosing the right conversations, the right tradeoffs, and, especially, the right techniques.

6.3 PROCUREMENT AND CONTRACTS

As mentioned earlier in this practice guide, the Agile Manifesto values “customer collaboration over contract negotiation.” Many project failures stem from breakdowns in the customer–supplier relationship. Projects incur more risk when those involved in the contract take the perspective of winners vs. losers. A collaborative approach is one that pursues a shared-risk-reward relationship, where all sides win. Some contracting techniques that can formalize this dynamic include the following:

- ◆ **Multi-tiered structure.** Rather than formalizing an entire contracting relationship in a single document, project parties can achieve more flexibility by describing different aspects in different documents. Mostly fixed items (e.g., warranties, arbitration) can be locked in a master agreement. Meanwhile, all parties list other items subject to change (e.g., services rates, product descriptions) in a schedule of services. The contract can reference them in the master services agreement. Finally, more dynamic items such as scope, schedule, and budget can be formalized in a lightweight statement of work. Isolating the more changing elements of a contract into a single document simplifies modifications and thus flexibility.
- ◆ **Emphasize value delivered.** Many vendor relationships are governed by fixed milestones or “phase gates” focused on intermediate artifacts, rather than a full deliverable of incremental business value. Often, these controls limit the use of feedback to improve the product. Instead, milestones and payment terms can be structured based on value-driven deliverables in order to enhance the project’s agility.
- ◆ **Fixed-price increments.** Rather than lock an entire project scope and budget into a single agreement, a project can decompose the scope into fixed-price microdeliverables, such as user stories. For the customer, this gives more control over how the money is spent. For the supplier, it limits the financial risk of over-commitment to a single feature or deliverable.

Culture versus Structure

TIP

Some people insist new organizational structures be installed before any cultural shift can begin. Others maintain the opposite—those new organizational structures are only superficial adjustments until the collective culture moves in a meaningful direction. In reality, one cannot progress without the other. Project leaders wanting to achieve agility should consider the current and future states of both of these aspects in their organization.

- ◆ **Not-to-exceed time and materials.** Customers incur unwanted risk from a traditional time and materials approach. One alternative is to limit the overall budget to a fixed amount. This allows the customer to incorporate new ideas and innovations into the project not originally planned. When customers want to incorporate new ideas, they will have to manage to a given capacity, replacing original work with new work. Work should be closely monitored as hours allocated reach their limit. Also, additional contingency hours could be planned into the maximum budget if considered helpful.
- ◆ **Graduated time and materials.** Another alternative is a shared financial risk approach. In agile, the quality criteria are part of what done means. Therefore, the supplier can be rewarded with a higher hourly rate when delivery is earlier than the contracted deadline. Conversely, the supplier would suffer a rate reduction for late delivery.
- ◆ **Early cancellation option.** When an agile supplier delivers sufficient value with only half of the scope completed, the customer should not be bound to pay the remaining half if the customer no longer needs it. Instead, a contract can offer the customer to buy the remainder of the project for a cancellation fee. The customer limits budget exposure and the supplier earns positive revenue for services no longer required.
- ◆ **Dynamic scope option.** For those contracts with a fixed budget, a supplier may offer the customer the option to vary the project scope at specified points in the project. The customer can adjust features to fit the capacity. Then the customer can leverage innovation opportunities, while limiting the supplier's risk of over commitment.
- ◆ **Team augmentation.** Arguably the most collaborative contracting approach is to embed the supplier's services directly into the customer organization. Funding teams instead of a specific scope preserves the customer's strategic discretion on what work should actually be done.

- ◆ **Favor full-service suppliers.** In order to diversify risk, customers may seek a multisupplier strategy. However, the temptation will be to contract the work such that each supplier does only one thing, which creates a web of dependencies before any usable service or product emerges. Instead, place an emphasis on engagements that deliver full value (as in the idea of completed independent feature sets).

It is possible to create agile contracts. Agile is built on a synergy of collaboration and trust. The supplier can help by delivering value early and often. The customer can help by providing timely feedback.

6.4 BUSINESS PRACTICES

The willingness and ability to create new competences within an organization when the need arises is a mark of organizational agility. These do not have to be earth-shattering changes and could be less disruptive in an organization that is focused on agility and the results it provides. Transparency and open collaboration are absolutely key.

As cross-functional teams deliver value, the teams and individuals might encounter problems with various support functions in the organization.

As team delivers value on a regular basis, finance departments may have the opportunity to capitalize the product differently. If the team has contracts with other organizations, procurement departments may need to change those contracts to help the other organizations deliver value frequently and synchronize with the team.

Once teams start to work in a cohesive and cooperative manner, they will challenge internal management policies. Human resources may notice individual incentives make less sense, and managers may struggle with the performance appraisals of self-organizing employees. In each case, these are opportunities to review the degree to which existing practices support agile ways of working.

As organizations progress to greater agility, there will be obvious needs for additional business units to change the way they interact and perform their responsibilities. The changes that have benefited other areas of the organization should now be embraced so the effectiveness of the entire organization can be realized.

6.5 MULTITEAM COORDINATION AND DEPENDENCIES (SCALING)

Many projects incur dependencies, even when they are not managed within a given program. For this reason, it is necessary to have an understanding of how agile works within an existing program and portfolio management context.

6.5.1 FRAMEWORKS

The guidance of the most widespread agile methods such as Scrum and eXtreme Programming focus on the activities of a single, small, usually colocated, cross-functional team. While this is very useful for efforts that require a single team, it may provide insufficient guidance for initiatives that require the collaboration of multiple agile teams in a program or portfolio.

A range of frameworks (such as the Scaled Agile Framework, Large Scale Scrum, and Disciplined Agile) and approaches (e.g., Scrum of Scrums) have emerged to cater to just such circumstances. More details on these can be found in Annex A3.

6.5.2 CONSIDERATIONS

There is more than one way to scale work. The team might need to scale the work of several agile projects into a single agile program. Alternatively, the organization can design a structure that supports agile approaches across the entire portfolio.

For example, it is helpful to start small and learn as rapidly as possible what works well in the organizational context. Teams can achieve successful outcomes even when everything is not completely transformed into an agile approach.

Regardless of the approach, a critical success factor is the healthy agile team. If using an agile approach for a single team is not successful, do not try to scale up to using it more broadly; instead, address the organizational impediments that prevent teams from working in an agile way.

The goal of large-scale agile projects is to coordinate the efforts of different teams to bring value to customers. There is more than one way to do that. Teams may use a formal framework or apply agile thinking to adjust existing program management practices.

6.6 AGILE AND THE PROJECT MANAGEMENT OFFICE (PMO)

The PMO exists to shepherd business value throughout the organization. It might do this by helping projects achieve their goals. Sometimes, the PMO educates teams (or arranges for training) and supports projects. Sometimes, the PMO advises management about the relative business value for a given project or set of projects.

Because agile creates cultural change, over time, the organization might need to change, including the PMO. For example, managers make decisions about which projects to fund and when, and teams decide what they need for training or advice.

6.6.1 AN AGILE PMO IS VALUE-DRIVEN

Any project should deliver the right value, to the right audience, at the right time. The PMO's objective is to facilitate and enable this goal. An agile-based PMO approach is based on a customer-collaboration mindset and is present in all PMO programs. In many cases, this means the PMO operates as if it were a consulting business, tailoring its efforts to meet specific needs requested by a given project. Some projects may need tools and templates, while others may benefit from executive coaching. The PMO should strive to deliver what is needed and keep the pulse on its customers to ensure that it knows and is able to adapt to their needs. This intrapreneur approach focuses on the PMO activities that are perceived as the most valuable to the projects it supports.

6.6.2 AN AGILE PMO IS INVITATION-ORIENTED

In order to accelerate progress on a value-based charter, a PMO may be tempted to mandate certain solutions or approaches, for example, to make everyone do it the same way to get some quick wins. However, a more deliberate perspective incorporates the desire for employee engagement. This is achieved by inviting only those interested to engage with PMO services. Higher engagement with PMO practices makes it easier for those practices to be “sticky.” If the PMO is delivering value to its clients, it is more likely that clients will request its services and adopt its practices.

6.6.3 AN AGILE PMO IS MULTIDISCIPLINARY

In order to support project-specific needs, the PMO needs to be conversant in several competencies beyond project management itself, because different projects require distinct capabilities. For instance, one project may need organizational design to address staffing challenges while another may require organizational change management techniques for stakeholder engagement or unique business models to support customer goals.

Some organizations have been transforming their PMOs into agile centers of excellence that provide such services as:

- ◆ **Developing and implementing standards.** Provide templates for user stories, test cases, cumulative flow diagrams, etc. Provide agile tools and educate supporting groups on iterative development concepts.
- ◆ **Developing personnel through training and mentoring.** Coordinate agile training courses, coaches, and mentors to help people transition to an agile mindset and upgrade their skills. Encourage and support people to attend local agile events.
- ◆ **Multiproject management.** Coordinate between agile teams by communicating between projects. Consider sharing items such as progress, issues, and retrospective findings and improvement experiments. Help manage major customer releases at the program level and investment themes at the portfolio level using an appropriate framework.
- ◆ **Facilitating organizational learning.** Gather project velocity profiles and capture, store, and index retrospective findings.
- ◆ **Managing stakeholders.** Provide product owner training, guidance on acceptance testing, and how to evaluate and give feedback on systems. Champion the importance of subject matter experts (SMEs) to projects.
- ◆ **Recruiting, selecting, and evaluating team leaders.** Develop guidelines for interviewing agile practitioners.
- ◆ **Executing specialized tasks for projects.** Train and provide retrospective facilitators, create agreements with agile project troubleshooters, and provide mentors and coaches.

6.7 ORGANIZATIONAL STRUCTURE

The structure of an organization strongly influences its ability to pivot to new information or shifting market needs. Here is a listing of key characteristics:

- ◆ **Geography.** Geographically distributed and dispersed project organizations may find several challenges impeding their work on any project. Project leaders and regional managers may have alternative or even competing goals. Additionally, cultural differences, language barriers, and lower visibility can slow down productivity. Fortunately, the use of agile approaches can encourage more collaboration and confidence than would otherwise exist. Project leaders in these contexts should encourage dialog at the team and executive level to tailor techniques for the context and to manage expectations about the effort required to do so.
- ◆ **Functionalized structures.** Some organizations are structured on a spectrum ranging from highly projectized to matrixed to highly functionalized. Projects with highly functionalized structures may find general resistance to collaboration across its organization.
- ◆ **Size of project deliverable.** Reducing the size of a project deliverable will motivate more frequent handoffs across departments, and thus more frequent interactions and a faster flow of value across the organization.
- ◆ **Allocation of people to projects.** Another approach is to ask for a single person from each department to be temporarily, yet fully allocated, to the highest priority project.
- ◆ **Procurement-heavy organizations.** Some organizations choose to implement projects primarily through vendors. Although project goals may be clear, vendors have a responsibility to look after their own financial viability. Moreover, once vendors complete their obligations and leave the engagement, the associated project knowledge goes with them. This limits the internal competencies needed for sustained flexibility and speed. Agile techniques such as retrospectives and follow up on possible improvement areas when the vendor is still engaged can help mitigate loss of product knowledge.

6.8 EVOLVING THE ORGANIZATION

When addressing an individual challenge area or implementing a new hybrid or agile approach, it is recommended to undertake the work incrementally. A common practice is to treat the change process as an agile project with its own backlog of changes that could be introduced and prioritized by the team, based on perceived value or other considerations. Each of the changes can be treated as an experiment, which is tested for a short period of time to determine suitability as-is or the need for further refinement/consideration.

Use kanban boards to track progress, showing the new approaches already in use as “done,” those being tried as “in progress,” and those still waiting to be introduced as “to do.” See Figure 6-3 for the initial board with a ranked backlog. Figure 6-4 shows an example of what a board might have as work progresses.



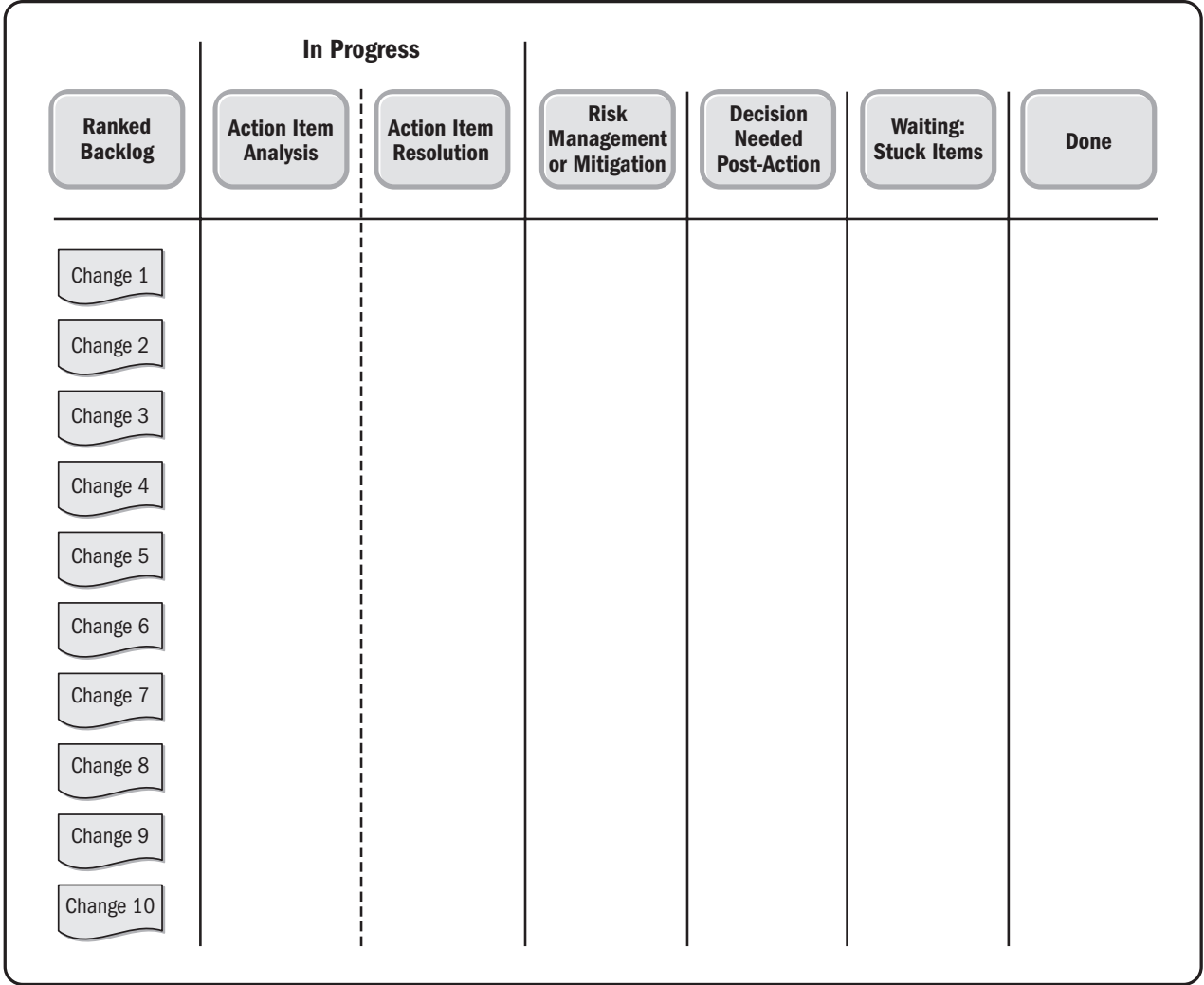

Figure 6-3. Initial Ranked Backlog for Changes



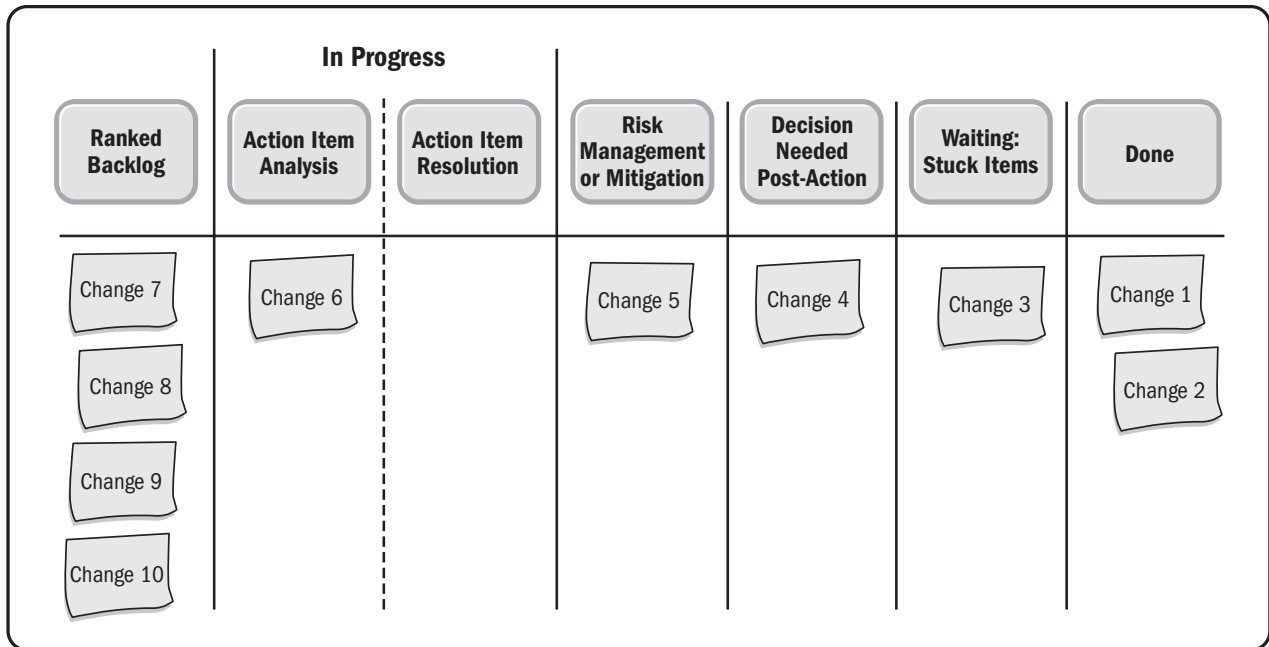

Figure 6-4. Using Backlogs and Kanban Boards to Organize and Track Change Work

Using these tools to organize and manage the change implementation provides visibility into progress and also models the approaches being implemented. Rolling out changes in a transparent and appealing way improves the likelihood of their success.

7

A CALL TO ACTION

The adoption of agile and its approaches for managing projects has increased dramatically since the Agile Manifesto was first published in 2001. Adoption and the desire to operate with an agile mindset is no longer limited to a certain sized organization or those specializing only in information technology. The mindset applies universally and the approaches are successful in many settings.

Today, the demand for “being agile” is higher than ever. The debate over the best path to agility continues to keep the conversation and innovation evolving. One truth remains constant—inspection, adaptation, and transparency are critical to successfully delivering value.

You may not see everything you expected to see in this practice guide. Our core team realizes you may disagree with some elements or approaches we did choose to present—and passionately so. We call on your passion to continue the conversation and improve the next iteration of this practice guide. This is your journey—learn, experiment, gain feedback, and experiment again. Then help us retrospect; give us feedback on the guidance and contribute to future editions of this practice guide. After all, inspection without adaptation is wasted effort.

Lastly, we want to encourage you to be engaged in the broader communities of project management and agile to further conversations on these topics. Look for representatives from both PMI and Agile Alliance® at conferences and meetings and engage them in discussion. Use social media and blog your thoughts and opinions.

You can provide feedback and engage in conversation regarding the contents of this practice guide at the blog called “Agile in Practice” at <https://www.projectmanagement.com/blogs/347350/Agile-in-Practice>.





ANNEX A1

PMBOK® GUIDE MAPPING

Table A1-1 illustrates the mapping of Project Management Process Groups to the Knowledge Areas defined in the *PMBOK® Guide – Sixth Edition*.

This annex describes how hybrid and agile approaches address the attributes described in the *PMBOK® Guide* Knowledge Areas (see Table A1-2). It covers what stays the same and what may be different along with some guidelines to consider for increasing the likelihood of success.

Table A1-1. Project Management Process Group and Knowledge Area Mapping

Knowledge Areas	Project Management Process Groups				
	Initiating Process Group	Planning Process Group	Executing Process Group	Monitoring and Controlling Process Group	Closing Process Group
4. Project Integration Management	4.1 Develop Project Charter	4.2 Develop Project Management Plan	4.3 Direct and Manage Project Work 4.4 Manage Project Knowledge	4.5 Monitor and Control Project Work 4.6 Perform Integrated Change Control	4.7 Close Project or Phase
5. Project Scope Management		5.1 Plan Scope Management 5.2 Collect Requirements 5.3 Define Scope 5.4 Create WBS		5.5 Validate Scope 5.6 Control Scope	
6. Project Schedule Management		6.1 Plan Schedule Management 6.2 Define Activities 6.3 Sequence Activities 6.4 Estimate Activity Durations 6.5 Develop Schedule		6.6 Control Schedule	
7. Project Cost Management		7.1 Plan Cost Management 7.2 Estimate Costs 7.3 Determine Budget		7.4 Control Costs	
8. Project Quality Management		8.1 Plan Quality Management	8.2 Manage Quality	8.3 Control Quality	
9. Project Resource Management		9.1 Plan Resource Management 9.2 Estimate Activity Resources	9.3 Acquire Resources 9.4 Develop Team 9.5 Manage Team	9.6 Control Resources	
10. Project Communications Management		10.1 Plan Communications Management	10.2 Manage Communications	10.3 Monitor Communications	
11. Project Risk Management		11.1 Plan Risk Management 11.2 Identify Risks 11.3 Perform Qualitative Risk Analysis 11.4 Perform Quantitative Risk Analysis 11.5 Plan Risk Responses	11.6 Implement Risk Responses	11.7 Monitor Risks	
12. Project Procurement Management		12.1 Plan Procurement Management	12.2 Conduct Procurements	12.3 Control Procurements	
13. Project Stakeholder Management	13.1 Identify Stakeholders	13.2 Plan Stakeholder Engagement	13.3 Manage Stakeholder Engagement	13.4 Monitor Stakeholder Engagement	

Table A1-2. Application of Agile in *PMBOK® Guide* Knowledge Areas

<i>PMBOK® Guide</i> Knowledge Area	Application in an Agile Work Process
<p>Section 4 Project Integration Management</p>	<p>Iterative and agile approaches promote the engagement of team members as local domain experts in integration management. The team members determine how plans and components should integrate.</p> <p>The expectations of the project manager as noted in the <i>Key Concepts for Integration Management</i> sections in the <i>PMBOK® Guide</i> do not change in an adaptive environment, but control of the detailed product planning and delivery is delegated to the team. The project manager's focus is on building a collaborative decision-making environment and ensuring the team has the ability to respond to changes. This collaborative approach can be further enhanced when team members possess a broad skill base rather than a narrow specialization.</p>
<p>Section 5 Project Scope Management</p>	<p>In projects with evolving requirements, high risk, or significant uncertainty, the scope is often not understood at the beginning of the project or it evolves during the project. Agile methods deliberately spend less time trying to define and agree on scope in the early stage of the project and spend more time establishing the process for its ongoing discovery and refinement. Many environments with emerging requirements find that there is often a gap between the real business requirements and the business requirements that were originally stated. Therefore, agile methods purposefully build and review prototypes and release versions in order to refine the requirements. As a result, scope is defined and redefined throughout the project. In agile approaches, the requirements constitute the backlog.</p>



Table A1-2. Application of Agile in *PMBOK® Guide Knowledge Areas (cont.)*

PMBOK® Guide Knowledge Area	Application in an Agile Work Process
<p>Section 6 Project Schedule Management</p>	<p>Adaptive approaches use short cycles to undertake work, review the results, and adapt as necessary. These cycles provide rapid feedback on the approaches and suitability of deliverables, and generally manifest as iterative scheduling and on-demand, pull-based scheduling, as discussed in the Key Trends and Emerging Practices section for Project Schedule Management in the <i>PMBOK® Guide</i>.</p> <p>In large organizations, there may be a mixture of small projects and large initiatives requiring long-term roadmaps to manage the development of these programs using scaling factors (e.g., team size, geographical distribution, regulatory compliance, organizational complexity, and technical complexity). To address the full delivery life cycle for larger, enterprise-wide systems, a range of techniques utilizing a predictive approach, adaptive approach, or a hybrid of both, may need to be adopted. The organization may need to combine practices from several core methods, or adopt a method that has already done so, and adopt a few principles and practices of more traditional techniques.</p> <p>The role of the project manager does not change based on managing projects using a predictive development life cycle or managing projects in adaptive environments. However, to be successful in using adaptive approaches, the project manager will need to be familiar with the tools and techniques to understand how to apply them effectively.</p>
<p>Section 7 Project Cost Management</p>	<p>Projects with high degrees of uncertainty or those where the scope is not yet fully defined may not benefit from detailed cost calculations due to frequent changes. Instead, lightweight estimation methods can be used to generate a fast, high-level forecast of project labor costs, which can then be easily adjusted as changes arise. Detailed estimates are reserved for short-term planning horizons in a just-in-time fashion.</p> <p>In cases where high-variability projects are also subject to strict budgets, the scope and schedule are more often adjusted to stay within cost constraints.</p>

Table A1-2. Application of Agile in *PMBOK® Guide Knowledge Areas (cont.)*

PMBOK® Guide Knowledge Area	Application in an Agile Work Process
<p>Section 8 Project Quality Management</p>	<p>In order to navigate changes, agile methods call for frequent quality and review steps built in throughout the project rather than toward the end of the project.</p> <p>Recurring retrospectives regularly check on the effectiveness of the quality processes. They look for the root cause of issues then suggest trials of new approaches to improve quality. Subsequent retrospectives evaluate any trial processes to determine if they are working and should be continued or new adjusting or should be dropped from use.</p> <p>In order to facilitate frequent, incremental delivery, agile methods focus on small batches of work, incorporating as many elements of project deliverables as possible. Small batch systems aim to uncover inconsistencies and quality issues earlier in the project life cycle when the overall costs of change are lower.</p>
<p>Section 9 Project Resource Management</p>	<p>Projects with high variability benefit from team structures that maximize focus and collaboration, such as self-organizing teams with generalizing specialists.</p> <p>Collaboration is intended to boost productivity and facilitate innovative problem solving. Collaborative teams may facilitate accelerated integration of distinct work activities, improve communication, increase knowledge sharing, and provide flexibility of work assignments in addition to other advantages.</p> <p>Although the benefits of collaboration also apply to other project environments, collaborative teams are often critical to the success of projects with a high degree of variability and rapid changes, because there is less time for centralized tasking and decision making.</p> <p>Planning for physical and human resources is much less predictable in projects with high variability. In these environments, agreements for fast supply and lean methods are critical to controlling costs and achieving the schedule.</p>



Table A1-2. Application of Agile in *PMBOK® Guide Knowledge Areas (cont.)*

<i>PMBOK® Guide Knowledge Area</i>	Application in an Agile Work Process
<p>Section 10 Project Communications Management</p>	<p>Project environments subject to various elements of ambiguity and change have an inherent need to communicate evolving and emerging details more frequently and quickly. This motivates streamlining team member access to information, frequent team checkpoints, and colocating team members as much as possible.</p> <p>In addition, posting project artifacts in a transparent fashion, and holding regular stakeholder reviews are intended to promote communication with management and stakeholders.</p>
<p>Section 11 Project Risk Management</p>	<p>High-variability environments, by definition, incur more uncertainty and risk. To address this, projects managed using adaptive approaches make use of frequent reviews of incremental work products and cross-functional project teams to accelerate knowledge sharing and ensure that risk is understood and managed. Risk is considered when selecting the content of each iteration, and risks will also be identified, analyzed, and managed during each iteration.</p> <p>Additionally, the requirements are kept as a living document that is updated regularly, and work may be reprioritized as the project progresses, based on an improved understanding of current risk exposure.</p>

Table A1-2. Application of Agile in *PMBOK® Guide Knowledge Areas (cont.)*

PMBOK® Guide Knowledge Area	Application in an Agile Work Process
<p>Section 12 Project Procurement Management</p>	<p>In agile environments, specific sellers may be used to extend the team. This collaborative working relationship can lead to a shared risk procurement model where both the buyer and the seller share in the risk and rewards associated with a project.</p> <p>Larger projects may use an adaptive approach for some deliverables and a more stable approach for other parts. In these cases, a governing agreement such as a master services agreement (MSA) may be used for the overall engagement, with the adaptive work being placed in an appendix or supplement. This allows changes to occur on the adaptive scope without impacting the overall contract.</p>
<p>Section 13 Project Stakeholder Management</p>	<p>Projects experiencing a high degree of change require active engagement and participation with project stakeholders. To facilitate timely, productive discussion and decision making, adaptive teams engage with stakeholders directly rather than going through layers of management. Often the client, user, and developer exchange information in a dynamic co-creative process that leads to more stakeholder involvement and higher satisfaction. Regular interactions with the stakeholder community throughout the project mitigate risk, build trust, and support adjustments earlier in the project cycle, thus reducing costs and increasing the likelihood of success for the project.</p> <p>In order to accelerate the sharing of information within and across the organization, agile methods promote aggressive transparency. The intent of inviting any stakeholders to project meetings and reviews or posting project artifacts in public spaces is to surface as quickly as possible any misalignment, dependency, or other issue related to the changing project.</p>





ANNEX A2

AGILE MANIFESTO MAPPING

This annex describes how the elements of the Agile Manifesto are covered in the *Agile Practice Guide*.

Table A2-1. Agile Manifesto Values Covered in the *Agile Practice Guide*

Value	<i>Agile Practice Guide</i> Coverage by Section and Title
Individuals and interactions over processes and tools	4.2 Servant Leadership Empowers the Team 4.3 Team Composition 5.1 Charter the Project and the Team 5.2.4 Daily Standups 6.2 Organizational Culture
Working software over comprehensive documentation	5.2.2 Backlog Preparation 5.2.3 Backlog Refinement 5.2.5 Demonstrations/Reviews 5.2.7 Execution Practices that Help Teams Deliver Value
Customer collaboration over contract negotiation	4.3 Team Composition 5.4 Measurements in Agile Projects 6.2 Organizational Culture 6.3 Procurement and Contracts 6.7 Organizational Structure
Responding to change over following a plan	5.2.1 Retrospectives 5.2.3 Backlog Refinement 5.2.5 Demonstrations/Reviews

Table A2-2. Agile Practice Guide Mapping of Principles Behind the Agile Manifesto

Principle	Agile Practice Guide Coverage
Our highest priority is to satisfy the customer through early and continuous delivery of valuable software.	3.1 Characteristics of Project Life Cycles 5.2.7 Execution Practices that Help Teams Deliver Value
Welcome changing requirements, even late in development. Agile processes harness change for the customer's competitive advantage.	5.2.3 Backlog Refinement
Deliver working software frequently, from a couple of weeks to a couple of months, with a preference to the shorter timescale.	5.2 Common Agile Practices
Business people and developers must work together daily throughout the project.	4.2 Servant Leadership Empowers the Team 5.2.2 Backlog Preparation 5.2.3 Backlog Refinement
Build projects around motivated individuals. Give them the environment and support they need, and trust them to get the job done.	4.3 Team Composition 5.1 Charter the Project and the Team 5.2.1 Retrospectives
The most efficient and effective method of conveying information to and within a development team is face-to-face conversation.	4.3.4 Team Structures 5.2.4 Daily Standups
Working software is the primary measure of progress.	5.2.7 Execution Practices that Help Teams Deliver Value 5.2.8 How Iterations and Increments Help Delivery Working Product
Agile processes promote sustainable development. The sponsors, developers, and users should be able to maintain a constant pace indefinitely.	5.1 Charter the Project and the Team
Continuous attention to technical excellence and good design enhances agility.	5.2 Common Agile Practices
Simplicity—the art of maximizing the amount of work not done is essential.	5.2.2 Backlog Preparation 5.2.3 Backlog Refinement
The best architectures, requirements, and designs emerge from self-organizing teams.	4.3 Team Composition
At regular intervals, the team reflects on how to become more effective, then tunes and adjusts its behavior accordingly.	5.2.1 Retrospectives

ANNEX A3

OVERVIEW OF AGILE AND LEAN FRAMEWORKS

This annex describes some of the commonly used agile approaches. These approaches can be used as is or combined to adapt to what works best for a given environment or situation. It is not necessary to use any of these; an agile approach can be developed from scratch as long as it adheres to the mindset, values, and principles of the Agile Manifesto. If the agile principles are followed to deliver value at a sustainable pace, and the developed approach promotes collaboration with the customer, a specific approach is not required. A link to more information regarding each approach can be found in the Bibliography section of this guide.

A3.1 SELECTION CRITERIA FOR THE *AGILE PRACTICE GUIDE*

There are too many agile approaches and techniques to be explicitly included in this practice guide. Figure A3-1 depicts a sample of agile approaches based on their depth of guidance and breadth of their life cycles. The specific approaches selected for discussion are popular examples that are:

- ◆ **Designed for holistic use.** Some agile approaches are centered on a single project activity, such as estimation or reflecting. The listed examples include only the more holistic agile frameworks. Some are more full-featured than others, but all of the selected approaches are those intended to guide a broad set of project activities.
- ◆ **Formalized for common use.** Some agile frameworks are proprietary in nature and designed for specific use by a single organization or within a single context. The frameworks described in Sections A3.2 through A3.14 focus on those intended for common use in a variety of contexts.
- ◆ **Popular in modern use.** Some agile frameworks are holistically designed and well formalized, but are simply not commonly being used in most projects or organizations. The agile frameworks described in this annex have been adopted by a significant number of industries, as measured by a collection of recent industry surveys.

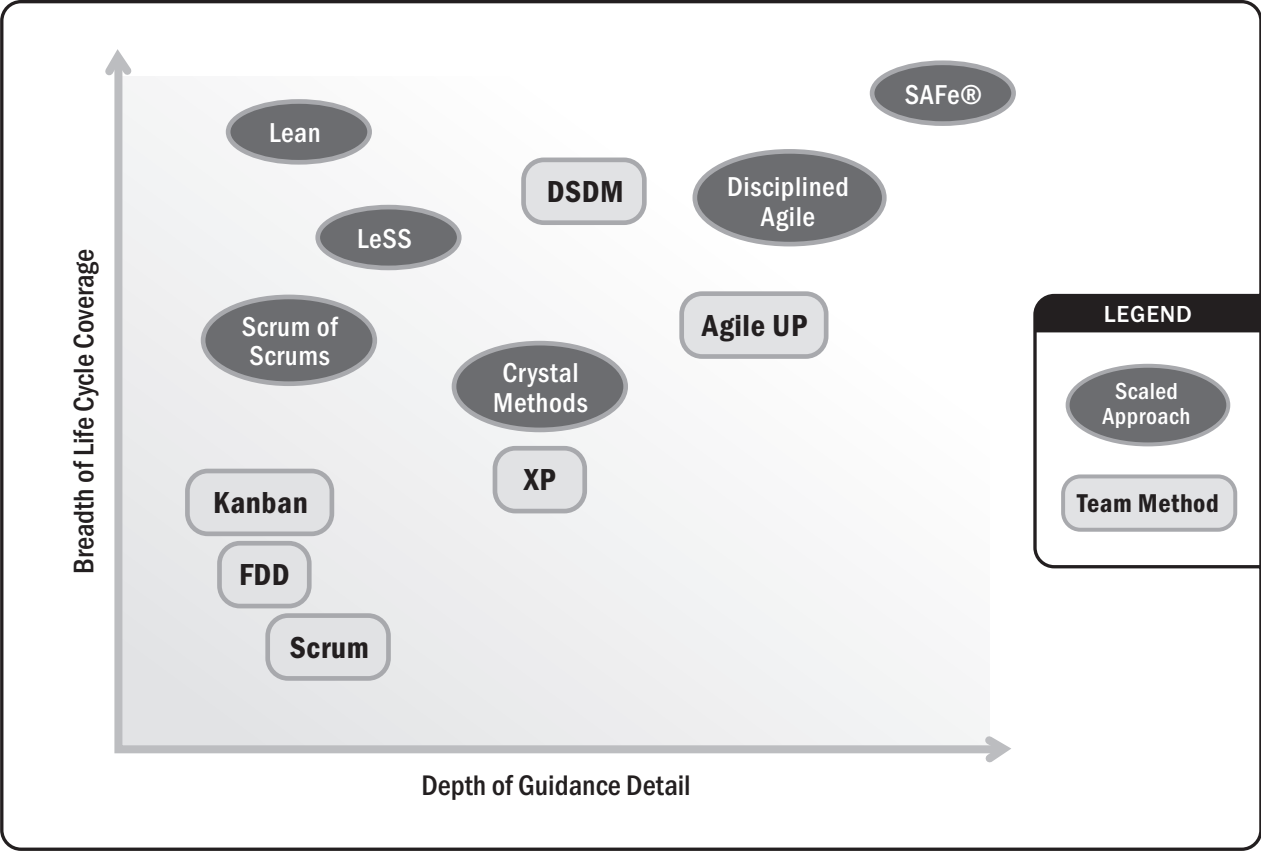

Figure A3-1. Agile Approaches Plotted by Breadth and Detail

A3.2 SCRUM

Scrum is a single-team process framework used to manage product development. The framework consists of Scrum roles, events, artifacts, and rules, and uses an iterative approach to deliver working product. Scrum is run on timeboxes of 1 month or less with consistent durations called sprints where a potentially releasable increment of product is produced. Table A3-1 lists Scrum events and artifacts utilized for project execution.

The Scrum team consists of a product owner, development team, and scrum master.

- ◆ The product owner is responsible for maximizing the value of the product.
- ◆ The development team is a cross-functional, self-organizing team consisting of team members who have everything they need within the team to deliver working product without depending on others outside of the team.
- ◆ The scrum master is responsible for ensuring the Scrum process is upheld and works to ensure the Scrum team adheres to the practices and rules as well as coaches the team on removing impediments.

Table A3-1. Scrum Events and Artifacts

Events	Artifacts
Sprint Sprint planning Daily scrum Sprint review Sprint retrospective	Product backlog Sprint backlog Increments

A3.3 EXTREME PROGRAMMING

eXtreme Programming (XP) is a software development method based on frequent cycles. The name is based on the philosophy of distilling a given best practice to its purest, simplest form, and applying that practice continuously throughout the project.

XP is most known for popularizing a holistic set of practices intended to improve the results of software projects. The method was first formalized as a set of twelve primary practices, but then gradually evolved to adopt several other corollary practices. These are listed in Table A3-2.

Table A3-2. The Practices of eXtreme Programming

XP Practice Area	Primary	Secondary
Organizational	<ul style="list-style-type: none"> • Sit together • Whole team • Informative workspace 	<ul style="list-style-type: none"> • Real customer involvement • Team continuity • Sustainable pace
Technical	<ul style="list-style-type: none"> • Pair programming • Test-first programming • Incremental design 	<ul style="list-style-type: none"> • Shared code/collective ownership • Documentation from code and tests • Refactoring
Planning	<ul style="list-style-type: none"> • User stories • Weekly cycle • Quarterly cycle • Slack 	<ul style="list-style-type: none"> • Root cause analysis • Shrinking teams • Pay per use • Negotiated scope contract • Daily standups
Integration	<ul style="list-style-type: none"> • 10-minute build • Continuous integration • Test-first 	<ul style="list-style-type: none"> • Single code base • Incremental deployment • Daily deployment

This evolution was the result of designing and adopting techniques through the filter of core values (communication, simplicity, feedback, courage, respect), and informed by key principles (humanity, economics, mutual benefit, self-similarity, improvement, diversity, reflection, flow, opportunity, redundancy, failure, quality, baby steps, accepted responsibility).

A3.4 KANBAN METHOD

Kanban in lean manufacturing is a system for scheduling inventory control and replenishment. This process of “just-in-time” inventory replenishment was originally seen in grocery stores when shelves were restocked based on the gaps in the shelves and not supplier inventory. Inspired by these just-in-time inventory systems, Taiichi Ohno developed Kanban and it was applied at the main Toyota manufacturing facility in 1953.

The word *kanban* is literally translated as “visual sign” or “card.” Physical kanban boards with cards enable and promote the visualization and flow of the work through the system for everyone to see. This information radiator (large display) is made up of columns that represent the states the work needs to flow through in order to get to done. The simplest of boards could have three columns (i.e., to do, doing, and done), but it is adaptable to whatever states are deemed needed by the team utilizing it.

The Kanban Method is utilized and applicable in many settings and allows for a continuous flow of work and value to the customer. The Kanban Method is less prescriptive than some agile approaches and thus less disruptive to begin implementing as it is the original “start where you are” method. Organizations can begin applying Kanban Methods with relative ease and progress toward fully implementing the method if that is what they deem necessary or appropriate.

Unlike most agile approaches, the Kanban Method does not prescribe the use of timeboxed iterations. Iterations can be used within the Kanban Method, but the principle of pulling single items through the process continuously and limiting work in progress to optimize flow should always remain intact. The Kanban Method may be best used when a team or organization is in need of the following conditions:

- ◆ **Flexibility.** Teams are typically not bound by timeboxes and will work on the highest priority item in the backlog of work.
- ◆ **Focus on continuous delivery.** Teams are focused on flowing work through the system to completion and not beginning new work until work in progress is completed.
- ◆ **Increased productivity and quality.** Productivity and quality are increased by limiting work in progress.

- ◆ **Increased efficiency.** Checking each task for value adding or non-value-added activities and removing the non-value adding activities.
- ◆ **Team member focus.** Limited work in progress allows the team to focus on the current work.
- ◆ **Variability in the workload.** When there is unpredictability in the way that work arrives, and it becomes impossible for teams to make predictable commitments; even for short periods of time.
- ◆ **Reduction of waste.** Transparency makes waste visible so it can be removed.

The Kanban Method is derived from lean thinking principles. The defining principles and the core properties of the Kanban Method are listed in Table A3-3.

The Kanban Method is a holistic framework for incremental, evolutionary process and systems change for organizations. The method uses a “pull system” to move the work through the process. When the team completes an item, the team can pull an item into that step.

Table A3-3. Defining Principles and Properties of the Kanban Method

Defining Principles	Core Properties
Start with current state Agree to pursue incremental, evolutionary change Respect the current process, roles, responsibilities, and titles Encourage acts of leadership at all levels	Visualize the workflow Limit work in progress Manage flow Make process policies explicit Implement feedback loops Improve collaboratively

Kanban boards, such as the one shown in Figure A3-2, are a low-tech, high-touch technology that may seem overly simplistic at first, but those using them soon realize their power. Utilizing policies for entry and exit to columns, as well as constraints such as limiting work in process, kanban boards provide clear insight to workflow, bottlenecks, blockers, and overall status. Additionally the board acts as an information radiator to anyone who sees it, providing up-to-date information on the status of the work of the team.

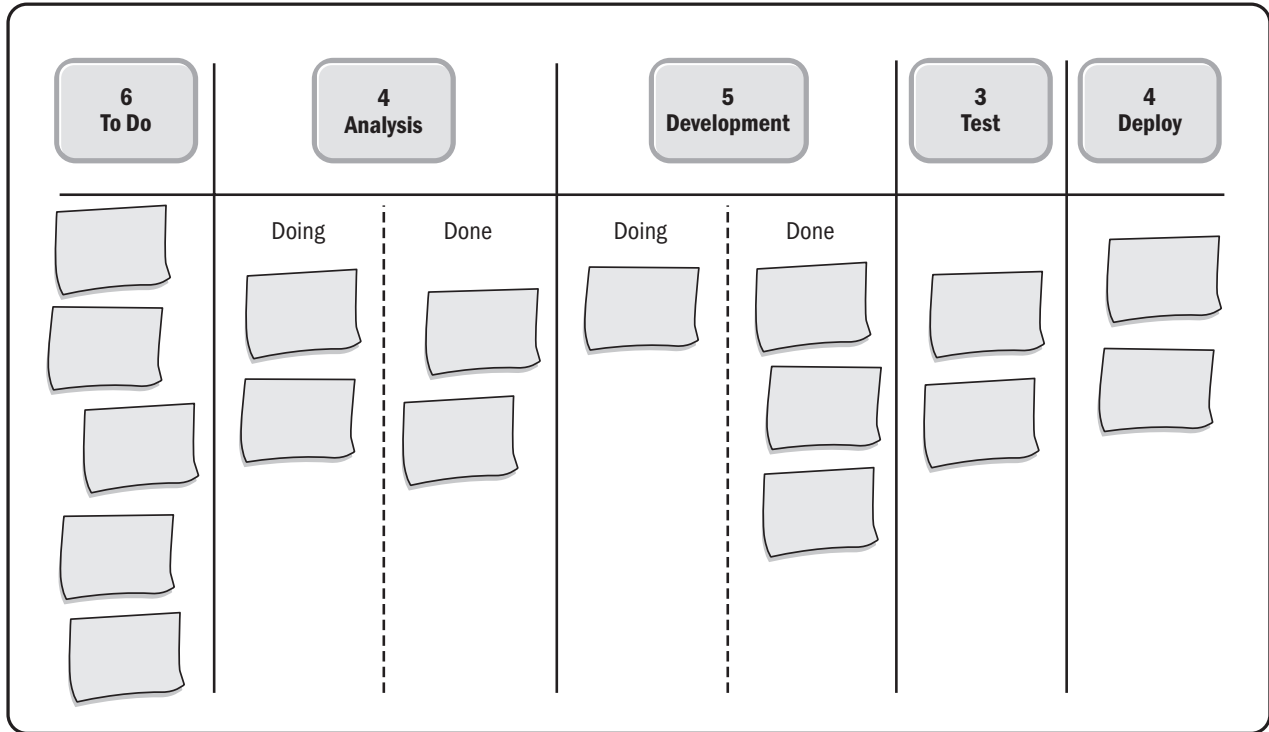

Figure A3-2. Kanban Board Demonstrating Work in Progress Limits, and a Pull System to Optimize the Flow of Work

In the Kanban Method, it is more important to complete work than it is to start new work. There is no value derived from work that is not completed so the team works together to implement and adhere to the work in progress (WIP) limits and get each piece of work through the system to “done.”

A3.5 CRYSTAL METHODS

Crystal is a family of methodologies. Crystal methodologies are designed to scale, and provide a selection of methodology rigor based on project size (number of people involved in the project) and the criticality of the project.

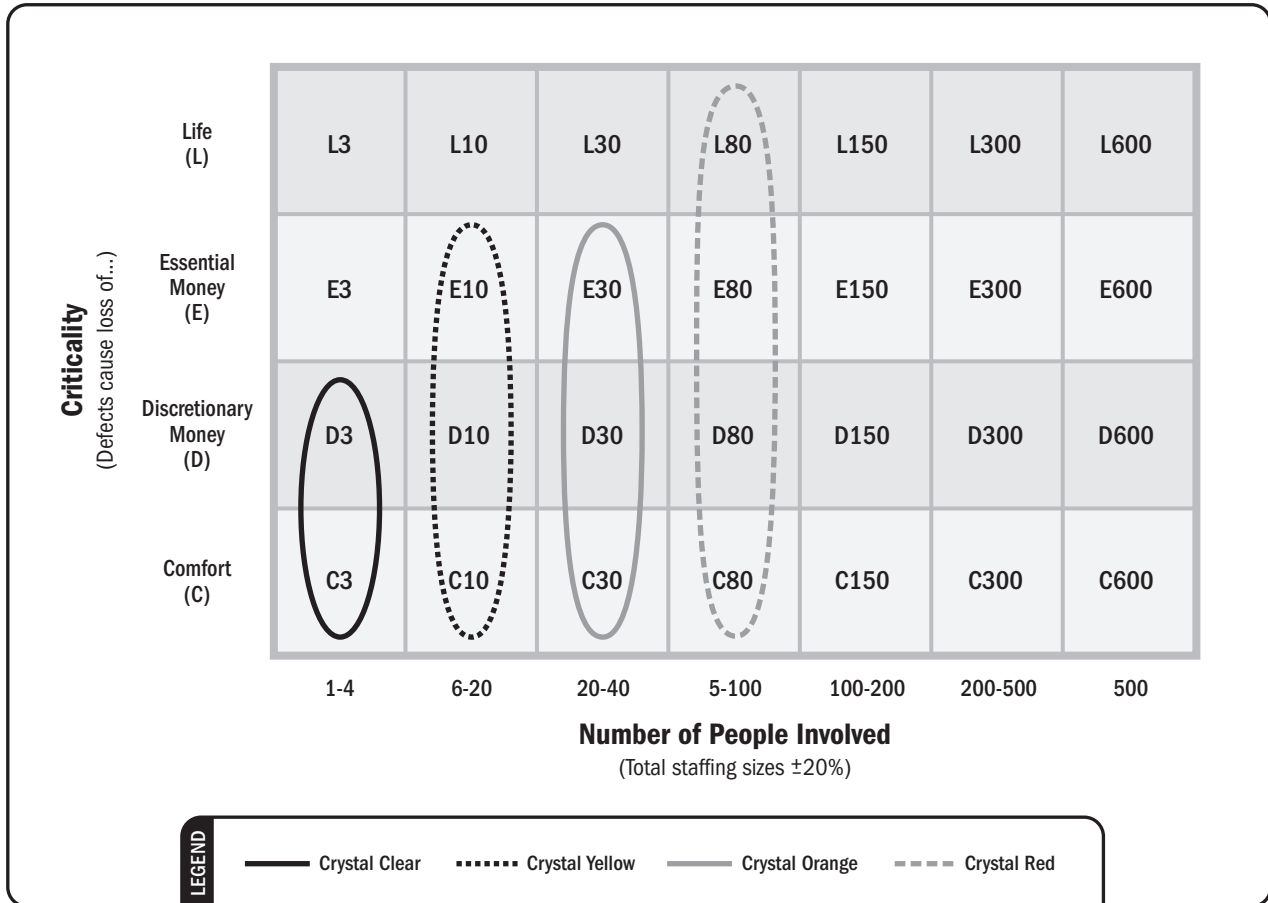

Figure A3-3. The Crystal Family of Methods

Crystal Methodology realizes that each project may require a slightly tailored set of policies, practices, and processes in order to meet the project’s unique characteristics. The family of methodologies use different colors based on “weight” to determine which methodology to use. The use of the word crystal comes from the gemstone where the various “faces” represent underlying core principles and values. The faces are a representation of techniques, tools, standards, and roles listed in Table A3-4.

Table A3-4. The Core Values and Common Properties of Crystal

Core Values	Common Properties ^A
People Interaction Community Skills Talents Communications	Frequent delivery Reflective improvement Close or osmotic communication Personal safety Focus Easy access to expert users Technical environment with automated tests, configuration management, and frequent integration

^AThe more these properties are in a project, the more likely it is to succeed.



A3.6 SCRUMBAN

Scrumban is an agile approach originally designed as a way to transition from Scrum to Kanban. As additional agile frameworks and methodologies emerged, it became an evolving hybrid framework in and of itself where teams use Scrum as a framework and Kanban for process improvement.

In Scrumban, the work is organized into small “sprints” and leverages the use of kanban boards to visualize and monitor the work. The stories are placed on the kanban board and the team manages its work by using work-in-progress limits. Daily meetings are held to maintain the collaboration between the team and to remove impediments. A planning trigger is set in place for the team to know when to plan next, typically when the work-in-progress level is lower than a predetermined limit. There are no predefined roles in Scrumban—the team retains their current roles.

A3.7 FEATURE-DRIVEN DEVELOPMENT

Feature-Driven Development (FDD) was developed to meet the specific needs of a large software development project. Features relate to a small business value capability.

There are six primary roles on a Feature-Driven Development project where individuals can take on one or more of the following roles:

- ◆ Project manager,
- ◆ Chief architect,
- ◆ Development manager,
- ◆ Chief programmer,
- ◆ Class owner, and/or
- ◆ Domain expert.

A Feature-Driven Development project is organized around five processes or activities, which are performed iteratively:

- ◆ Develop an overall model,
- ◆ Build a features list,
- ◆ Plan by feature,
- ◆ Design by feature, and
- ◆ Build by features.

The life cycle flow and interaction of these five processes is illustrated in Figure A3-4.

Feature-Driven Development activities are supported by a core set of software engineering best practices:

- ◆ Domain object modeling,
- ◆ Developing by feature,
- ◆ Individual class ownership,
- ◆ Feature teams,
- ◆ Inspections,
- ◆ Configuration management,
- ◆ Regular builds, and
- ◆ Visibility of progress and results.

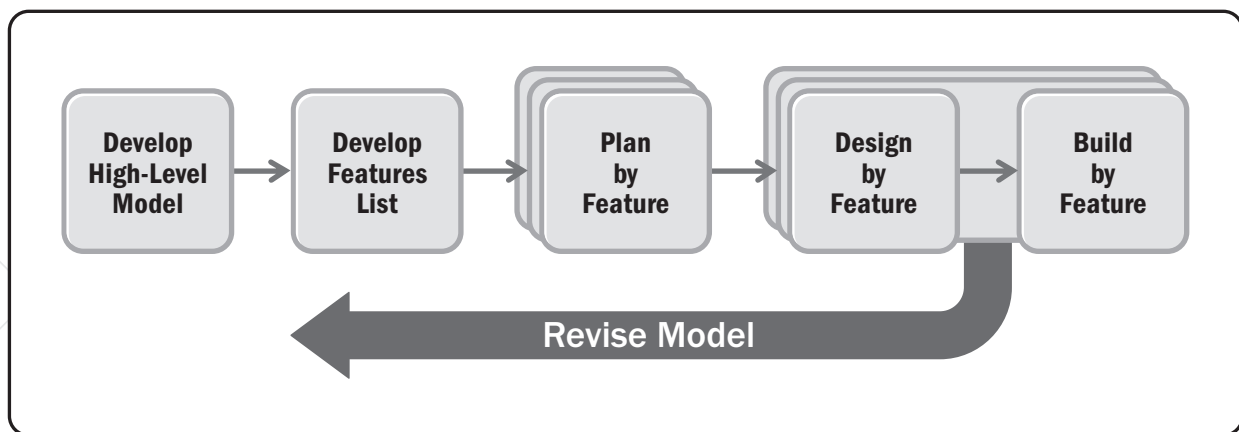

Figure A3-4. Feature-Driven Development Project Life Cycle

A3.8 DYNAMIC SYSTEMS DEVELOPMENT METHOD

Dynamic Systems Development Method (DSDM) is an agile project delivery framework initially designed to add more rigor to existing iterative methods popular in the 1990s. It was developed as a noncommercial collaboration among industry leaders.

DSDM is known best for its emphasis on constraint-driven delivery. The framework will set cost, quality, and time at the outset, and then use formalized prioritization of scope to meet those constraints as shown in Figure A3-5.

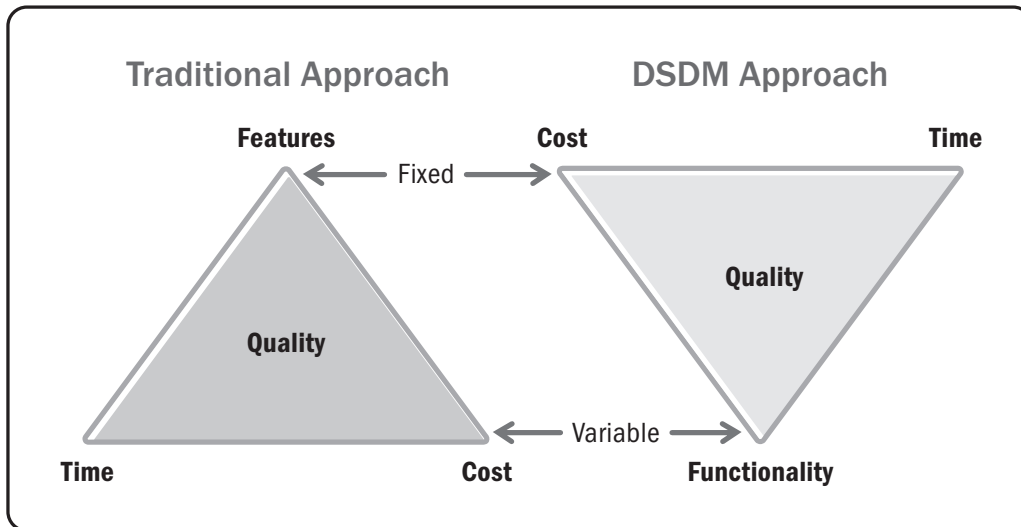

Figure A3-5. DSDM Approach to Constraint-Driven Agility

Eight principles guide the use of the DSDM framework:

- ◆ Focus on the business need.
- ◆ Deliver on time.
- ◆ Collaborate.
- ◆ Never compromise quality.
- ◆ Build incrementally from firm foundations.
- ◆ Develop iteratively.
- ◆ Communicate continuously and clearly.
- ◆ Demonstrate control (use appropriate techniques).

A3.9 AGILE UNIFIED PROCESS

The Agile Unified Process (AgileUP) is an offshoot of the Unified Process (UP) for software projects. It features more accelerated cycles and less heavyweight processes than its Unified Process predecessor. The intent is to perform more iterative cycles across seven key disciplines, and incorporate the associated feedback before formal delivery. The disciplines along with guiding principles are listed in Table A3-5.

Table A3-5. The Key Elements of the Agile Unified Process

Disciplines within a Release	Principles Guiding the Disciplines
Model	The team knows what it's doing
Implementation	Simplicity
Test	Agility
Deployment	Focus on high-value activities
Configuration management	Tool independence
Project management	Tailoring to fit
Environment	Situationally specific

A3.10 SCALING FRAMEWORKS

A3.10.1 SCRUM OF SCRUMS

Scrum of Scrums (SoS), also known as “meta Scrum,” is a technique used when two or more Scrum teams consisting of three to nine members each need to coordinate their work instead of one large Scrum team. A representative from each team attends a meeting with the other team representative(s), potentially daily but typically two to three times a week. The daily meeting is conducted similar to the daily standup in Scrum where the representative reports completed work, next set of work, any current impediments, and potential upcoming impediments that might block the other team(s). The goal is to ensure the teams are coordinating work and removing impediments to optimize the efficiency of all the teams.

Large projects with several teams may result in conducting a Scrum of Scrum of Scrums, which follows the same pattern as SoS with a representative from each SoS reporting into a larger group of representatives as shown in Figure A3-6.

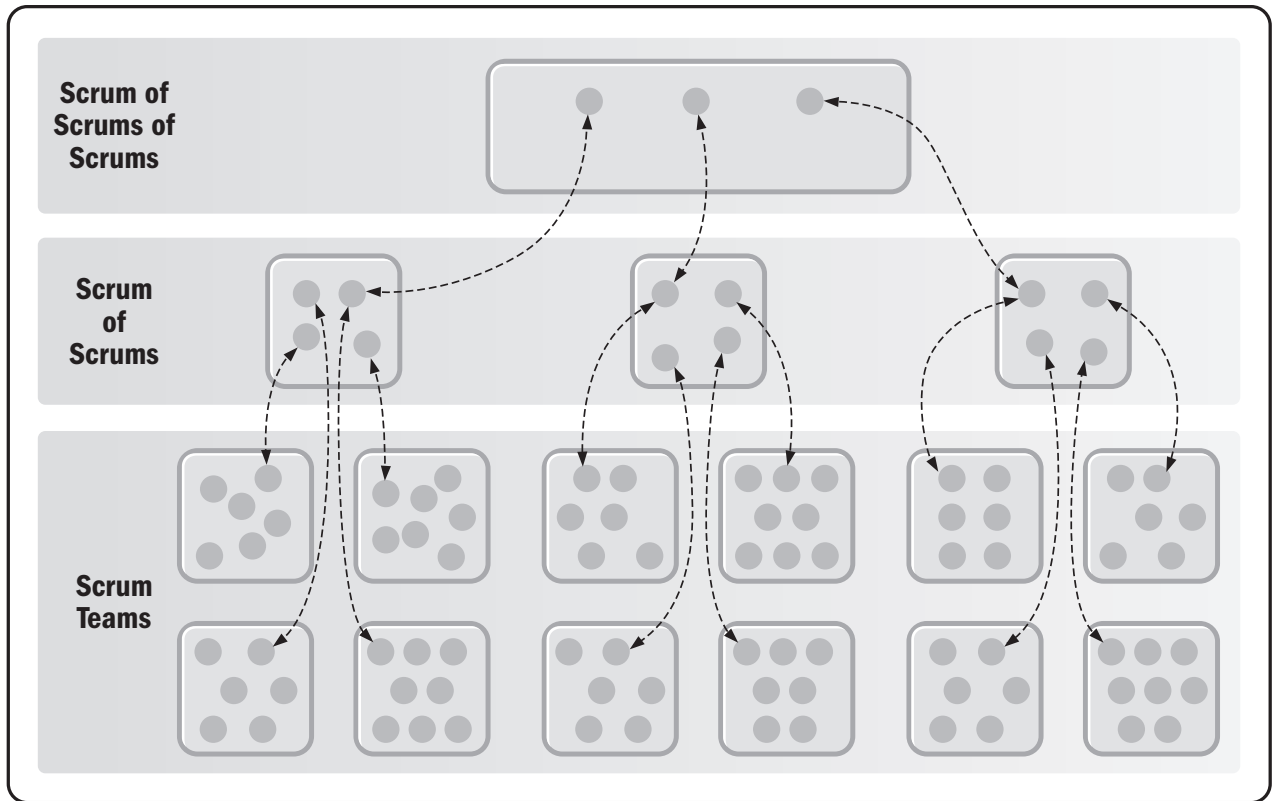

Figure A3-6. Representatives of Scrum Teams Participating in SoS teams

A3.11 SCALED AGILE FRAMEWORK

The Scaled Agile Framework (SAFe®) focuses on providing a knowledge base of patterns for scaling development work across all levels of the enterprise.

SAFe® is focused on the following principles:

- ◆ Take an economic view.
- ◆ Apply systems thinking.
- ◆ Assume variability; preserve options.
- ◆ Build incrementally with fast, integrated learning cycles.
- ◆ Base milestones on objective evaluation of working systems.

- ◆ Visualize and limit work in progress, reduce batch sizes, and manage queue lengths.
- ◆ Apply cadence; synchronize with cross-domain planning.
- ◆ Unlock the intrinsic motivation of knowledge workers.
- ◆ Decentralize decision making.

SAFe® focuses on detailing practices, roles, and activities at the portfolio, program, and team levels with an emphasis on organizing the enterprise around value streams that focus on providing continuous value to the customer.

A3.12 LARGE SCALE SCRUM (LeSS)

Large Scale Scrum (LeSS) is a framework for organizing several development teams toward a common goal extending the Scrum method shown in Figure A3-6. The core organizing principle is to retain as much as possible of the elements of the conventional single-team Scrum model. This helps minimize any extensions to the model that might create unnecessary confusion or complexity. Table A3-6 shows a comparison of LeSS and Scrum.

Table A3-6. Comparison of LeSS and Scrum

Similarities of LeSS and Scrum	LeSS Techniques Added to Scrum
One single product backlog One definition of done for all teams One potentially shippable product increment at the end of each sprint One product owner Complete, cross-functional teams One sprint	Sprint planning is more formally divided into two parts of what and how Organic cross-team coordination Overall cross-team refinement Overall retrospective focused on cross-team improvements

In order to extend Scrum without losing its essence, LeSS promotes the use of certain discerning principles, such as systems thinking, whole product focus, transparency, and others.

A3.13 ENTERPRISE SCRUM

Enterprise Scrum is a framework designed to apply the Scrum method on a more holistic organizational level rather than a single product development effort. Specifically, the framework advises organization leaders to:

- ◆ Extend the use of Scrum across all aspects of the organization;
- ◆ Generalize the Scrum techniques to apply easily at those various aspects; and
- ◆ Scale the Scrum method with supplemental techniques as necessary.

The intent is to use agile approaches beyond project execution by enabling disruptive innovation.

A3.14 DISCIPLINED AGILE (DA)

Disciplined Agile (DA) is a process decision framework that integrates several agile best practices into a comprehensive model. DA was designed to offer a balance between those popular methods deemed to be either too narrow in focus (e.g., Scrum) or too prescriptive in detail (e.g., AgileUP). To achieve that balance, it blends various agile techniques according to the following principles:

- ◆ **People-first.** Enumerating roles and organization elements at various levels.
- ◆ **Learning-oriented.** Encouraging collaborative improvement.
- ◆ **Full delivery life cycle.** Promoting several fit-for-purpose life cycles.
- ◆ **Goal-driven.** Tailoring processes to achieve specific outcomes.
- ◆ **Enterprise awareness.** Offering guidance on cross-departmental governance.
- ◆ **Scalable.** Covering multiple dimensions of program complexity.

APPENDIX X1

CONTRIBUTORS AND REVIEWERS

X1.1 AGILE PRACTICE GUIDE CORE COMMITTEE

The following individuals were members of the project Core Committee responsible for drafting the guide, including review and adjudication of reviewer recommendations.

X1.1.1 REPRESENTING THE PROJECT MANAGEMENT INSTITUTE:

Mike Griffiths, PMP, PMI-ACP, (Committee Chair)
Jesse Fewell, CST, PMI-ACP
Horia Slușanschi, PhD, CSM
Stephen Matola, BA, PMP

X1.1.2 REPRESENTING AGILE ALLIANCE:

Johanna Rothman, MS (Committee Vice Chair)
Becky Hartman, PMI-ACP, CSP
Betsy Kauffman, ICP-ACC, PMI-ACP



X1.2 AGILE PRACTICE GUIDE SUBJECT MATTER EXPERT REVIEWERS

The following individuals were invited subject matter experts who reviewed the draft and provided recommendations through the SME Review.

Joe Astolfi, PMP, PSM	Laura Paton, MBA, PMP
Maria Cristina Barbero, PMI-ACP, PMP	Yvan Petit, PhD, PMP
Michel Biedermann, PhD, PMI-ACP	Dwayne Phillips, PhD, PMP
Zach Bonaker	Piyush Prakash, PMP, Prince2
Robert Bulger, PfMP, CSM	Dave Prior, PMP, CST
Sue Burk	Daniel Rawsthorne, PhD, PMP
Shika Carter, PMP, PMI-ACP	Annette D. Reilly, PMP, PhD
Lauren Clark, PMP, CSM	Stephan Reindl, PMI-ACP, PMP
Linda M Cook, CSM, CSPO	Reed D. Shell, PMP, CSP
Pamela Corbin-Jones, PMI-ACP, CSM	Cindy Shelton, PMP, PMI-ACP
Jeff Covert	Teresa Short
Alberto Dominguez, MSc, PMP	Lisa K. Sieverts, PMP, PMI-ACP
Scott P. Duncan, CSM, ICP-ACC	Christopher M. Simonek, PMP, CSM
Sally Elatta, PMI-ACP, EBAC	Robert “Sellers” Smith, PMP, PMI-ACP
Frank R. Hendriks, PMP, PMI-ACP	Ram Srinivasan, PMP, CST
Derek Huether	Chris Stevens, PhD
Ron Jeffries	Karen Strichartz, PMP, PMI-ACP
Fred Koos	Rahul Sudame, PMI-ACP
Philippe B. Kruchten, PhD, PEng	Joanna L. Vahlsing, PMP
Steve Mayner, SPCT4, PMP	Erik L. van Daalen
Michael S. McCalla, PMI-ACP, CSP	Annette Vendelbo, PMP, PMI-ACP
Don B. McClure, PMP, PMI-ACP	Dave Violette, MPM, PMP
Anthony C. Mersino, PMI-ACP, CSP	Anton Vishnyak, PMI-ACP, CSM
Kenneth E. Nidiffer, PhD, PMP	Chuck Walrad, MA, MS
Michael C. Nollet, PMP, PMI-ACP	

X1.3 FORMAT FOCUS GROUP

The following individuals assisting in the development of new content style and formatting elements for the *Agile Practice Guide*.

Goran Banjanin, PgMP, PMP
Andrew Craig
Cătălin-Teodor Dogaru, PhD, PMP
Jorge Espinoza, PMP
Jennifer M. Forrest, CSM, PMP
Helen Fotos, PMP, PMI-ACP
Dave Hatter, PMP, PMI-ACP
Christopher Healy, PMP
Mike Hoffmann, MBA, PMP
Chadi Kahwaji, PMP
Rajaraman Kannan, PMP, MACS CP
Amit Khanna PMP, PMI-ACP
Ariel Kirshbom, PMI-ACP, CSP
Bernardo Marques, PMP
Noura Saad, PMI-ACP, CSPO
Kurt Schuler, PMP
Demetrius L. Williams, MBA, PMP
Liza Wood
Melody Yale, CSP, SPC4

X1.4 PMI STANDARDS MEMBER ADVISORY GROUP (MAG)

The following individuals are members of the PMI Standards Member Advisory Group, who provided direction to and final approval on behalf of PMI for the *Agile Practice Guide*.



Maria Cristina Barbero, PMI-ACP, PMP
Brian Grafsgaard, PMP, PgMP
Hagit Landman, PMP, PMI-SP
Yvan Petit PhD, PMP
Chris Stevens, PhD
Dave Violette, MPM, PMP
John Zlockie, MBA, PMP, PMI Standards Manager

X1.5 AGILE ALLIANCE® BOARD

The following individuals are members of Agile Alliance Board of Directors, who provided direction to and final approval on behalf of Agile Alliance for the *Agile Practice Guide*.

Juan Banda
Phil Brock (Managing Director)
Linda Cook
Stephanie Davis
Ellen Grove
Paul Hammond (Chair)
Victor Hugo Germano
Rebecca Parsons (Secretary)
Craig Smith
Declan Whelan

X1.6 PMI SUPPORT STAFF AND ACADEMIC RESEARCH SUPPORT

The following individuals worked to support the core committee in the development and approval of the draft, in support of the Format Focus Group, and in PMI marketing efforts.

Melissa M. Abel, Marketing Communications Specialist
Karl F. Best, PMP, CStd, Standards Specialist
Alicia C. Burke, MBA, CSM, Product Manager, Credentials
Edivandro C. Conforto, PhD, PMI Consultant on Agile Research
Dave Garrett, CSPO, Vice President, Transformation
Erica Grenfell, Administrative Assistant to VP, Organization Relations
M. Elaine Lazar, MA, MA, AStd, Project Specialist
Andrew Levin, PMP, Project Manager
Tim E. Ogline, User Experience Designer
Stephen A. Townsend, Director of Network Programs
Michael Zarro, PhD, UX Researcher

X1.7 PMI PRODUCTION STAFF

Donn Greenberg, Manager, Publications
Kim Shinnars, Publications Production Associate
Roberta Storer, Product Editor
Barbara Walsh, Production Supervisor

APPENDIX X2

ATTRIBUTES THAT INFLUENCE TAILORING

X2.1 INTRODUCTION

This appendix provides high-level guidance on when and how to tailor agile approaches. It can be used to determine circumstances that might warrant changing or introducing new techniques, and then offers some recommendations to consider.

X2.2 FIRST SOME CAUTIONS

Tailoring is an advanced topic that should be undertaken by experienced practitioners who have been successful using agile approaches as originally described in multiple environments before they consider tailoring them. In other words, gain experience and be successful with one approach before attempting to tailor the approach.

A common response when struggling to adopt an agile practice is to consider whether to do it or not. A statement like “Retrospectives were unpopular so we decided to drop them” illustrates this issue and indicates a more fundamental problem on the team that is unlikely to be addressed by tailoring the method. The situation will be made worse by omitting the retrospective activity that aims to improve the process.

The Shu-Ha-Ri model of skills acquisition describes progression from obeying the rules (Shu 守, means to obey and protect), through consciously moving away from the rules (Ha 破, means to change or digress), and finally through steady practice and improvement finding an individual path (Ri 離, means to separate or leave). We need to start and practice at the Shu level before we are ready to move to the Ha level to tailor the process or the Ri level to invent a new custom process.

Finally, tailoring should be undertaken in collaboration with the teammates or whoever the change is likely to impact. People need to be engaged in the thinking and decision-making process about changing processes in order for them to commit and buy-in to the changes in order to have a successful transition. Omitting people from tailoring a process is likely to result in resistance and resentment to the change, even if it makes good sense technically. Often, experienced coaches or leaders can help to engage people effectively.

X2.3 HOW TO USE THIS APPENDIX

To benefit from the guidance listed in this appendix, we recommend first successfully using the agile approaches as designed. Then review the tailoring guidelines in Table X2-1 that match the situation and read the associated recommendations. Next, discuss the change with the people it will impact and agree on a course of action.

As discussed in Section 5, a good way to evaluate a change is try it for an iteration or two first before adopting it permanently. Or, consider a flow-based approach to try to deliver several features. Then, reflect with a retrospective and reassess.

When people know they can experiment and provide feedback on the experiment, they are more likely to try something new. Having tried it for a timeboxed period, the team should review its effectiveness at a retrospective to determine whether it should be continued as-is, modified to improve it, or dropped from use.

Finally, successfully adopted, tailored approaches can be institutionalized into the standard processes used for projects that share these characteristics. It is also recommended that guidelines from Section 5 be followed that describe adopting (or tailoring) new approaches.

X2.4 TAILORING RECOMMENDATIONS

Listed below are some good practices to consider before tailoring an approach.

X2.4.1 BEWARE OF TAKING THINGS AWAY

Many of the agile practices act as self-supporting pairs. For instance, colocation and frequent business conversations allow for lightweight requirements since gaps in understanding can be filled quickly. Likewise, XP's ruthless testing allows for courageous refactoring as one practice supports the other. Removing something without understanding or addressing its counterbalanced practice will likely create more problems than it solves.

X2.4.2 USE THE TAILORING GUIDELINES TABLE

Using Table X2-1, find the circumstances that match a given situation and consider recommendations for tailoring. Discuss any changes with those who will be impacted by the change and plan a short trial first, along with an honest follow-up review before committing to the change.

Table X2-1. Tailoring Guidelines

Situation	Tailoring Recommendation
Very large project teams	<p>Restructure large projects as multiple smaller projects. Try a technology trial project first and then an implementation project.</p> <p>Consider more frequent releases of fewer features each, which allows for the creation of smaller project teams.</p> <p>Consider reducing the team down to its critical core members. Often too many people hinder a process, not help it. Reducing a team size can reduce churn as well as costs.</p> <p>Break large teams into multiple smaller teams and use program management to synchronize and coordinate.</p> <p>Use agile and lean program management to organize the larger effort.</p> <p>Consider a scaled agile or lean framework such as DA, SAFe®, or LeSS. Each offers some useful ideas, and each carries implementation risks and process weight/cost.</p>

Table X2-1. Tailoring Guidelines (cont.)

Situation	Tailoring Recommendation
Dispersed teams	<p>Many projects have (some) dispersed team members. Tools like instant messaging, video conferencing, and electronic team boards help bridge many of the communication gaps.</p> <p>When teams are likely to remain stable, set up face-to-face meetings as soon as possible to make future remote conversations more effective. People who have met face-to-face are more likely to enter unfiltered debate because of higher trust.</p> <p>When conducting meetings with remote participants where there is a loss of facial and body-language cues, consider round-robin check-ins to ensure participation and check consensus for decisions.</p> <p>Also, consider the use of iteration-based agile approaches. When team members are many time zones apart, consider using whole-project interactions less frequently, while encouraging more personal meetings (two or three people at a time) more frequently.</p>
Some safety critical products may require additional documentation and conformance checks beyond what agile processes suggest out-of-the-box	<p>Agile approaches can still be used in these environments, but they need to have the appropriate additional layers of conformance review, documentation, and certification that is required by the domain. In that case, documentation could be part of what the team delivers along with finished features. Features may not be done until the documentation is completed.</p> <p>Consider using a hybrid approach (multiple agile approaches) to get the benefits of improved collaboration and communication brought by agile with the added rigor required by the product environment. Aircraft flight system developers and drug companies use agile approaches coupled with their own additional processes to leverage the benefits and retain appropriate controls.</p>
Stable requirements and execution process	<p>Is agile really needed? If uncertainty in requirements is low, low rates of change, or minimal execution risk, the full suite of agile approaches may not be needed. While any project benefits from increased collaboration and transparency; some of the iterative build and review cycles might be overkill.</p> <p>If build/feedback cycles do not routinely uncover or refine requirements, consider extending their durations to minimize the cost impact of review time.</p> <p>If the project has high rates of change during design and development, but rolling it out to customers is a defined and repeatable process, hybrid approaches that use the appropriate life cycle model for each project phase may make more sense.</p>
Teams are in functional silos inside functional organizations	<p>Agile is built on the idea of cross-functional teams. Consider asking people to create cross-functional teams themselves, without management involvement and see what happens.</p> <p>If the compensation system is organized to recognize and reward functional areas, consider changing that first. People might not act in the interest of the product or the team until it affects their compensation in some way.</p>

Table X2-1. Tailoring Guidelines (cont.)

Situation	Tailoring Recommendation
Transparency can cause fear	<p>Agile creates a culture of transparency: people show and share their work throughout development. This sharing of interim deliverables and being open and honest about successes, failures, and current state is transparency. Transparency requires courage.</p> <p>Lead by example and demonstrate transparency in decision-making processes by using a status board or whiteboard.</p>
Many of the team members have little technical domain knowledge	<p>Agile approaches encourage and make use of self-directing teams to make local decisions about work items, such as task sequencing and which approach to use when solving a problem. When the majority of team members are inexperienced, consensus-based approaches may lead to problems and rework. So, for these teams, additional help “assigning” and “directing” may be necessary until the team gains the necessary skills. In other words, do not just declare that agile will be used and let an inexperienced team try to figure everything out because they are empowered and self-directing. Consider building centers of competencies to help provide guidance and build domain knowledge.</p>
Lack of executive buy-in	<p>When executive buy-in is missing, teams will encounter a clash between the agile mindset and approaches and the more predictive mindset and approaches.</p> <p>Find common ground, areas for improvement based on the organization’s needs, and then use experiments and retrospectives to progress.</p> <p>Consider education/training for executives. Consider explaining agile in terms of lean thinking: short cycles, small batch sizes, frequent reviews, and retrospectives with small improvements.</p>
Agile terms and language do not fit the organizational culture	<p>Modify the terms so people will understand and agree to the activities, if not the agile language. Be specific about what each term means.</p> <p>For example, if the organization finds the word “game” unprofessional, don’t use terms such as “planning game.” Instead, consider using the term “planning workshop.”</p>





APPENDIX X3

AGILE SUITABILITY FILTER TOOLS

X3.1 INTRODUCTION

Agile literature contains many agile suitability filter tools to help assess under what circumstances an agile approach is appropriate to use. In 1994, the Dynamic Systems Development Method (DSDM) developed an Agile Project Suitability Questionnaire and an Organizational Suitability Questionnaire to help gauge likely fit and potential problem areas.

The Crystal family of approaches also employed suitability criteria, ranking projects by team size and the criticality of the product or service being developed. Crystal recommends that smaller, less critical projects be undertaken with lighter controls and simpler approaches. Large, mission or life critical projects were recommended to use more rigor and validation.

Since the development of these approaches, there have been many more models created to help determine where and when to employ agile approaches. Boehm and Turner adopted some of the elements from DSDM and Crystal to develop a popular assessment model to help determine if projects should be undertaken with agile or more traditional approaches.

Based on these previous models and expanded to consider the middle ground of hybrid approaches, the following model is proposed. It represents a synthesis of several suitability filter attributes to help organizations assess and discuss whether projects should be undertaken using predictive, hybrid, or agile approaches.



X3.2 OVERVIEW OF THE MODEL

Organizational and project attributes are assessed under three main categories:

- ◆ **Culture.** Is there a supportive environment with buy-in for the approach and trust in the team?
- ◆ **Team.** Is the team of a suitable size to be successful in adopting agile, do its members have the necessary experience and access to business representatives to be successful?
- ◆ **Project.** Are there high rates of change? Is incremental delivery possible? How critical is the project?

Questions in each of these categories are answered and the results plotted on a radar chart. Clusters of values around the center of the chart indicate a good fit for agile approaches. Results around the outside indicate a predictive approach may be more suitable. Values in the middle portion (between agile and predictive) indicate a hybrid approach could work well. An example is shown in Figure X3-1.

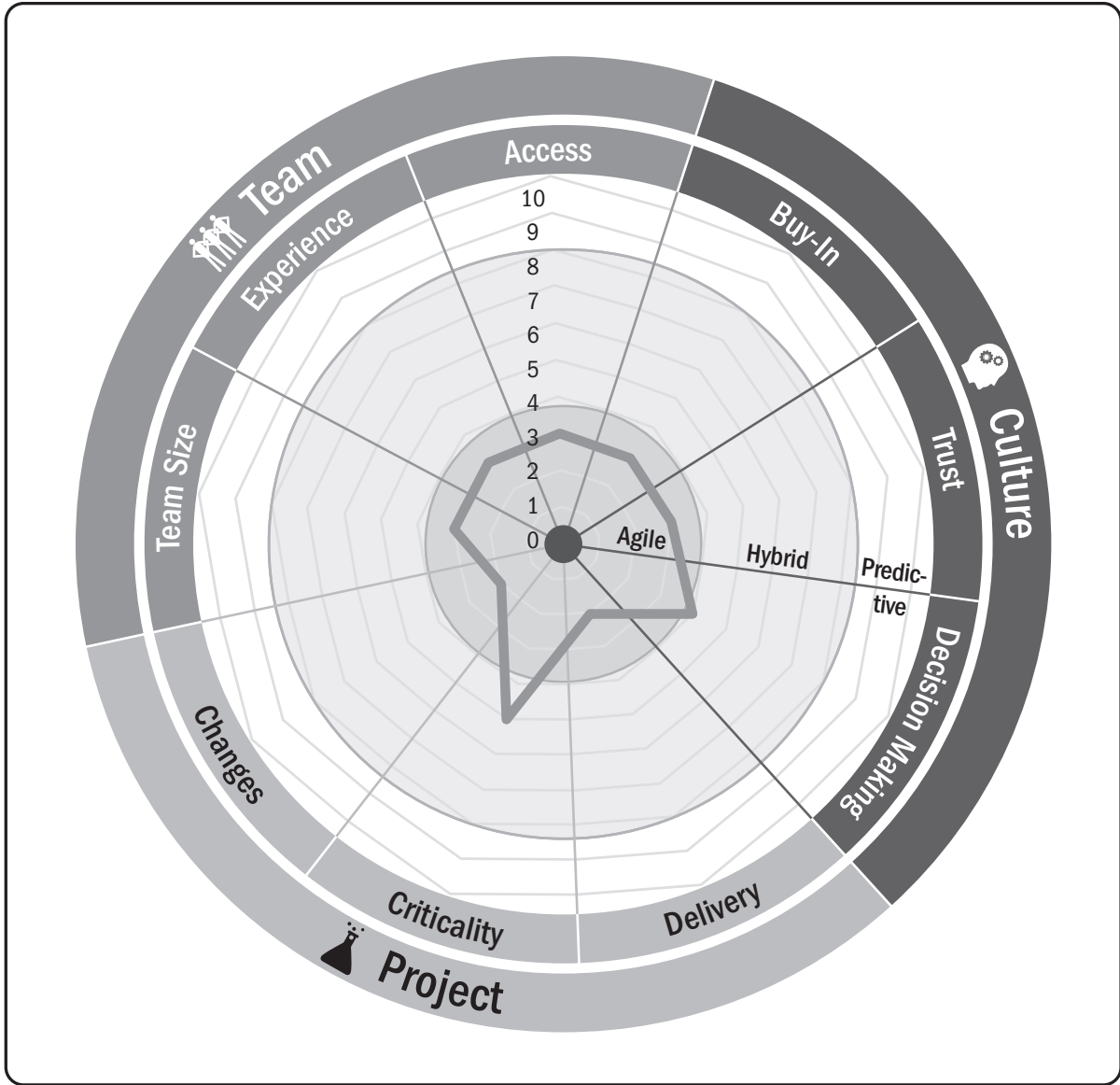

Figure X3-1. Model for Suitability of Agile Approach

X3.3 INSTRUCTIONS FOR USE

X3.3.1 COMPLETE THE QUESTIONNAIRE AS A GROUP

For small projects, this group may simply be the sponsor, technical lead, and a customer. For large projects, this may include representatives from the sponsoring group, project execution team, impacted business group(s), project governance group(s), and customer community. The idea is that just as no single stakeholder should estimate or plan a project because of representing only one viewpoint and having personal bias; so too should no single person assess the suitability of an approach since any one person will also have a limited view with a bias.

Instead, the value of the tool is the conversation it encourages with the invested parties of the project. Even if the results point to a hybrid approach, but the stakeholders want to proceed with a largely agile or predictive approach, follow the stakeholder consensus. This tool is a high-level diagnostic only, the final decision should rest and be supported by the people involved.

X3.3.2 SCORE THE QUESTIONS FROM 1 TO 10

As a group, discuss and agree (or compromise) on a score that most accurately reflects the subjective evaluation of the question. While definitive options are only provided for the start, middle, and end points of the answer spectrum representing scores of 1, 5, and 10, it is fine (and desirable) to use scores such as 2 for “almost a 1, but not quite,” or 7 for “somewhere between a 5 and a 10.” Again, the assessment is a discussion tool—views will be subjective and shades of gray are to be expected.

When the group cannot agree on a score, discuss the issues openly and honestly. Before suggesting compromises (i.e., using average scores or marking PMO scores with a blue “X” and the development team with a green “O”), consider how successful is the project likely to be when the participants cannot agree on completing a simple assessment? When discussing the issues, if the differences of opinion can be identified—then great, it is working; now come to an agreement. Likewise, if the assessment indicates a predictive approach but everyone wants to try an agile approach (or vice versa) that is fine too, just understand the issues and discuss how the impacts of the approach will be handled.

X3.3.3 INTERPRET THE RESULTS

Mark the answers from the questions on a blank suitability assessment chart and connect the points. Results clustered around the center in the agile zone indicate a good fit for a purely agile approach.

Results predominantly in the hybrid zone indicate some combination of agile and predictive approaches might work best. However, it is also possible that an agile approach with some additional risk reduction steps such as extra education and training or extra validation and documentation rigor in the case of high criticality projects may suffice. Alternatively, a predictive approach with some proof-of-concept work or extra processes could also work.

Results predominantly in the predictive zone indicate a good fit for a purely predictive approach. As mentioned in Section X3.3.2 (Score the Questions step), this diagnostic tool is aimed at starting meaningful conversations with the impacted parties about the most appropriate approach to use. If the approach suggested by the tool is not acceptable it is allowed to use a different approach. Use the results as inputs to the risk management process, since the tool indicates mismatches that will need to be managed.

X3.4 SUITABILITY FILTER QUESTIONS

X3.4.1 CATEGORY: CULTURE

X3.4.1.1 BUY-IN TO APPROACH

Is there senior sponsor understanding and support for using an agile approach for this project? See Figure X3-2.

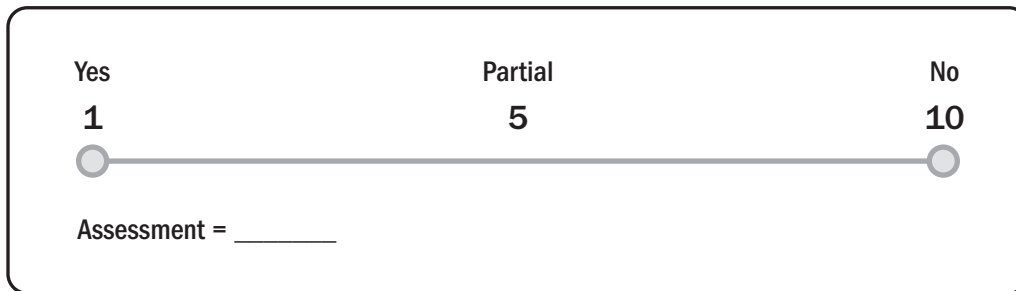

A horizontal assessment scale with three points: 'Yes' at 1, 'Partial' at 5, and 'No' at 10. A line connects the 1 and 10 points, with a grey circle at each end. Below the line is the text 'Assessment = _____'.

Yes	Partial	No
1	5	10

Assessment = _____

Figure X3-2. Buy-In to Approach Assessment

X3.4.1.2 TRUST IN TEAM

Considering the sponsors and the business representatives who will be working with the team. Do these stakeholders have confidence that the team can transform their vision and needs into a successful product or service—with ongoing support and feedback going both directions? See Figure X3-3.

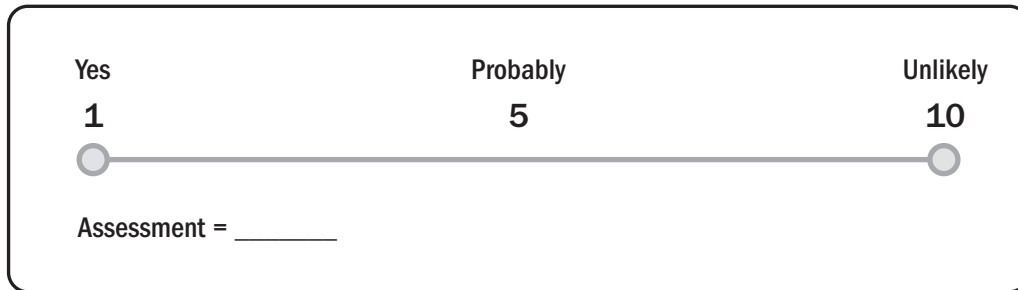

Figure X3-3. Trust in Team Assessment

X3.4.1.3 DECISION-MAKING POWERS OF TEAM

Will the team be given autonomy to make their own local decisions about how to undertake work? See Figure X3-4.

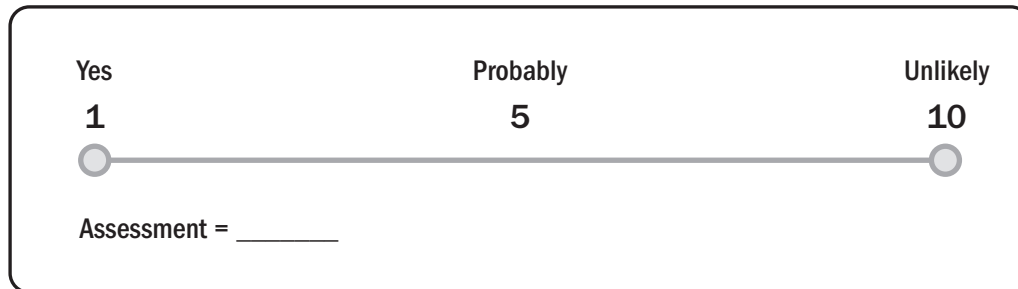

Figure X3-4. Assessment for Decision-Making Powers of Team

X3.4.2 CATEGORY: TEAM

X3.4.2.1 TEAM SIZE

What is the size of the core team? Use this scale: 1-9 = 1, 10-20 = 2, 21-30 = 3, 31-45 = 4, 46-60 = 5, 61-80 = 6, 81-110 = 7, 111-150 = 8, 151 – 200 = 9, 201+ = 10. See Figure X3-5.

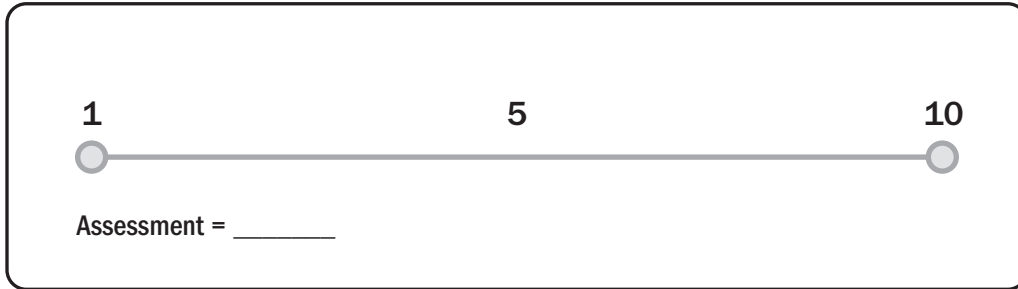

Figure X3-5. Team Size Assessment

X3.4.2.2 EXPERIENCE LEVELS

Considering the experience and skill levels of the core team roles. While it is normal to have a mix of experienced and inexperienced people in roles, for agile projects to go smoothly; it is easier when each role has at least one experienced member. See Figure X3-6.

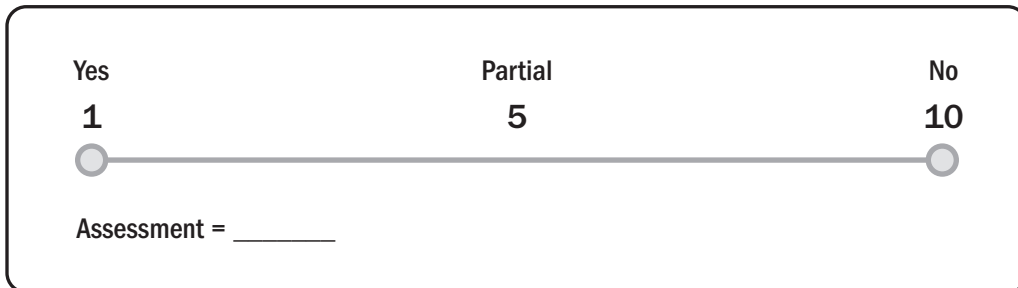

Figure X3-6. Experience Level Assessment

X3.4.2.3 ACCESS TO THE CUSTOMER/BUSINESS

Will the team have daily access to at least one business/customer representative to ask questions and get feedback?
See Figure X3-7.

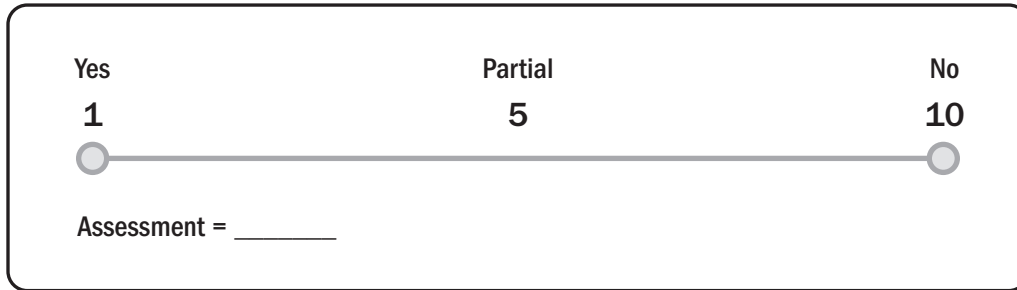

Figure X3-7. Assessment for Access to the Customer/Business

X3.4.3 CATEGORY: PROJECT

X3.4.3.1 LIKELIHOOD OF CHANGE

What percentage of requirements are likely to change or be discovered on a monthly basis? See Figure X3-8.

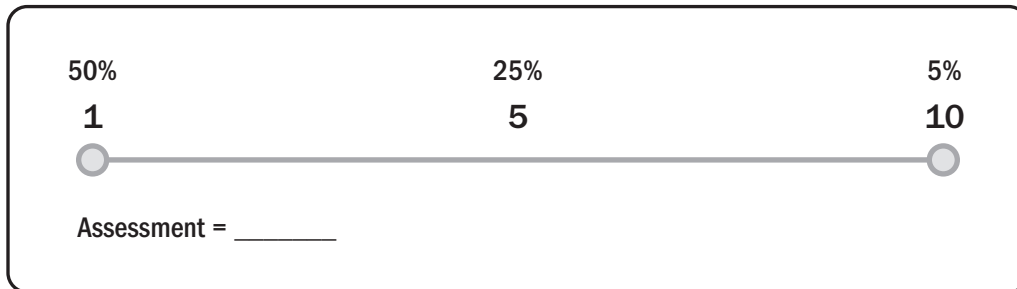

Figure X3-8. Likelihood of Change Assessment

X3.4.3.2 CRITICALITY OF PRODUCT OR SERVICE

To help determine likely levels of additional verification and documentation rigor that may be required, assess the criticality of the product or service being built. Using an assessment that considers loss due to possible impact of defects, determine what a failure could result in. See Figure X3-9.

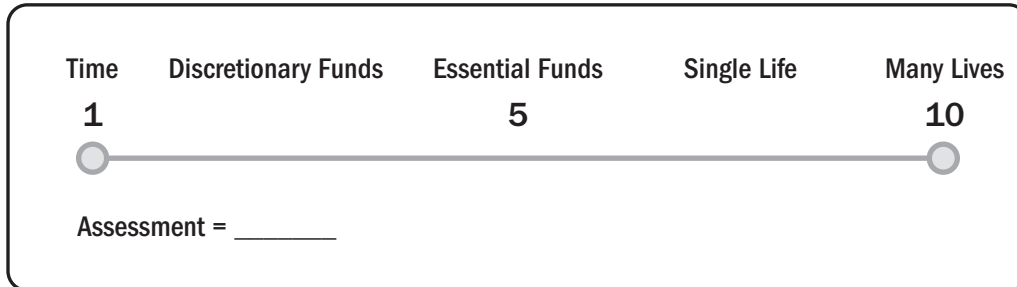

Figure X3-9. Assessment for Criticality of Product or Service

X3.4.3.3 INCREMENTAL DELIVERY

Can the product or service be built and evaluated in portions? Also, will business or customer representatives be available to provide timely feedback on increments delivered? See Figure X3-10.

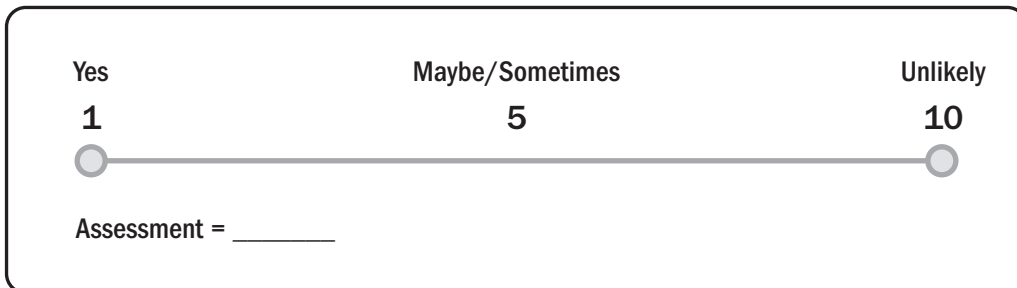

Figure X3-10. Incremental Delivery Assessment



X3.5 SUITABILITY ASSESSMENT CHART

Figure X3-11 is the radar chart used for the suitability assessment.

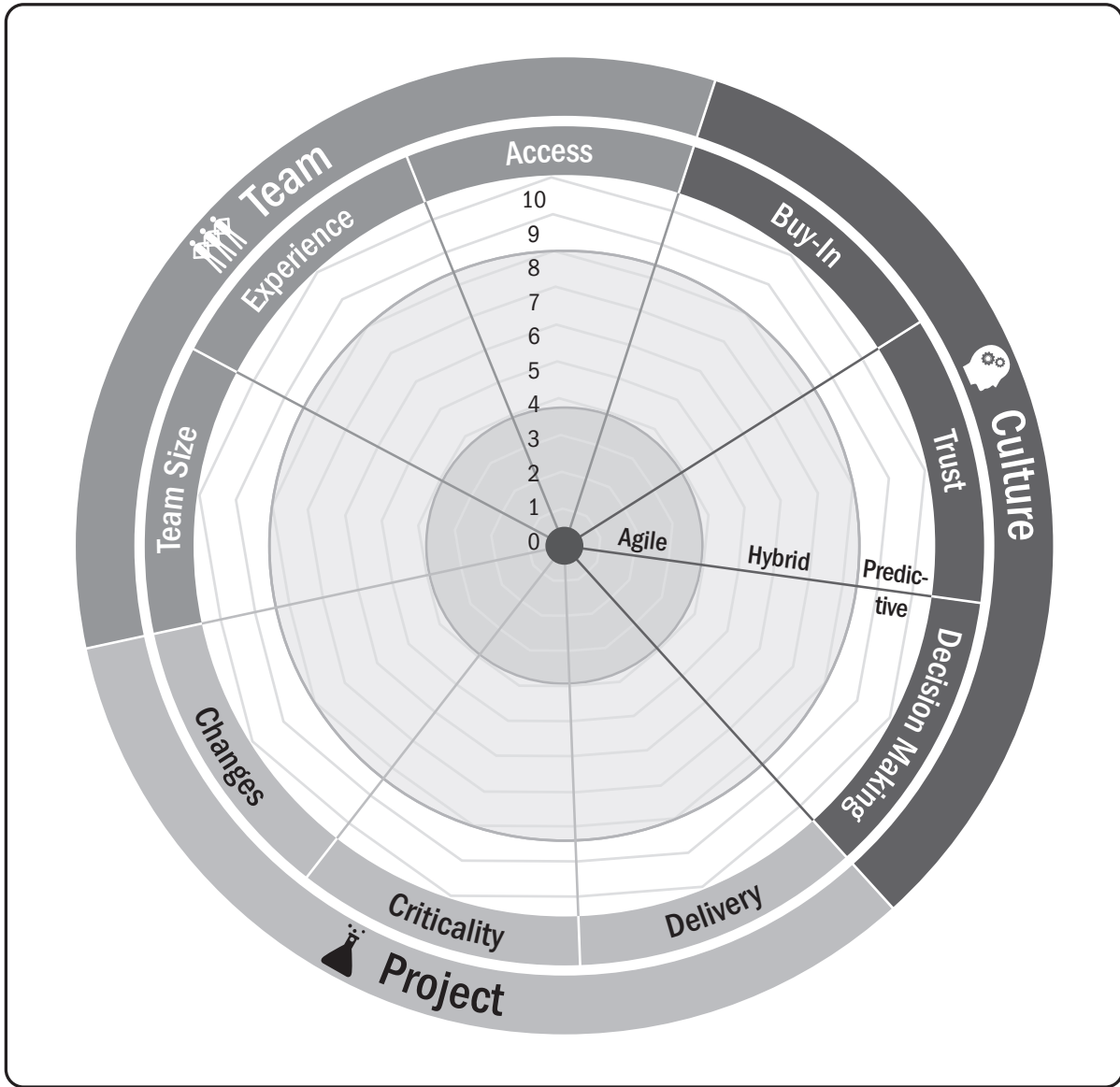

Figure X3-11. Suitability Assessment Radar Chart

X3.5.1 CASE STUDIES

To illustrate how the radar chart works, here are two examples of using the model to score very different types of projects. The first is an example of an online drug store project (see Figure X3-12) and the second (Figure X3-13) is an example of a military messaging system. These two case studies illustrate some of the variances seen on projects. Central clustering indicates a good fit for agile approaches, peripheral scores indicate predictive approaches might be more suitable. Some projects are centered around the middle but then spike out on one or two axes. These projects may be best solved with a hybrid approach.

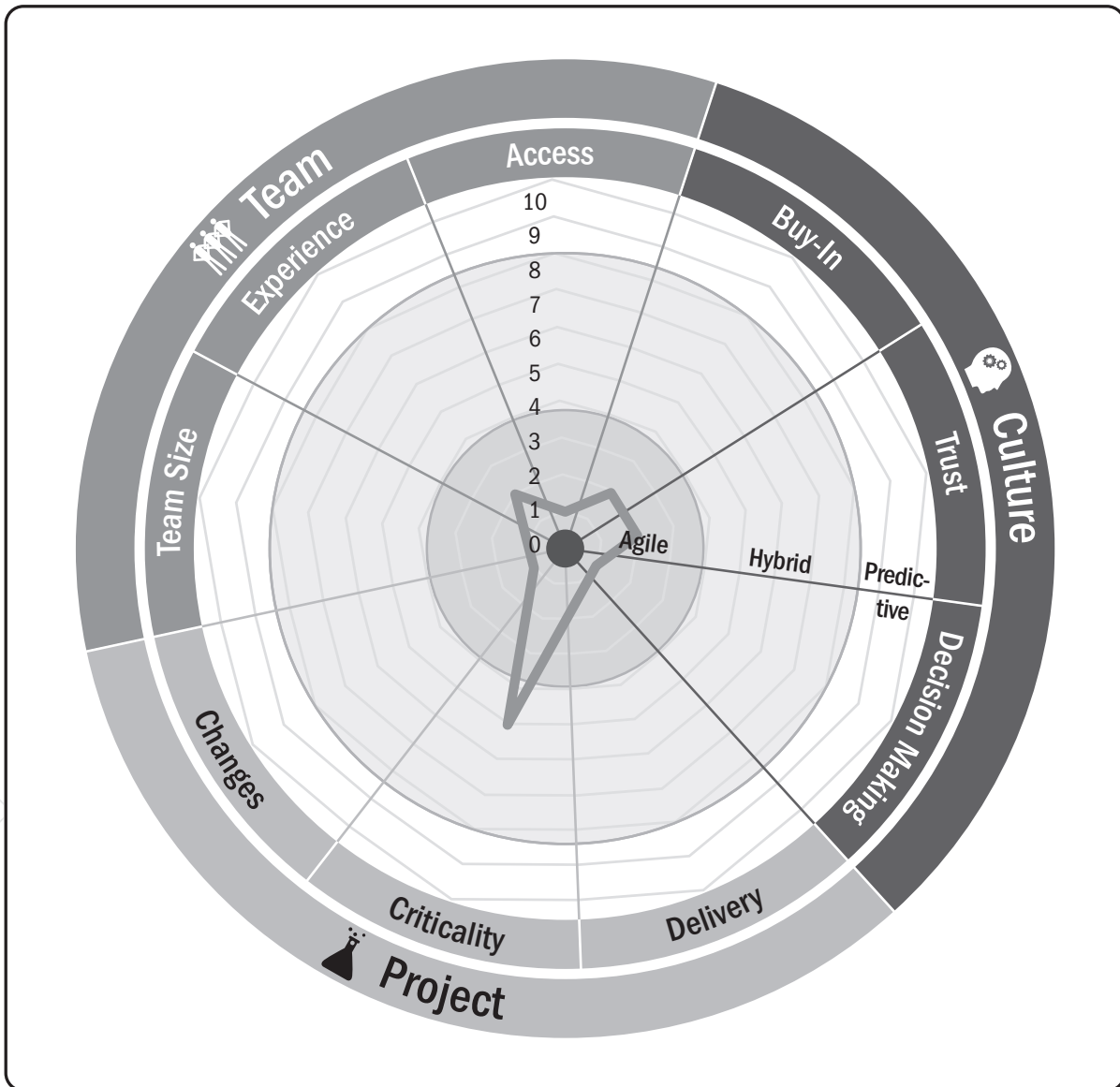

Figure X3-12. Drug Store Project

X3.5.1.1 DRUG STORE EXAMPLE

The project was to develop an online drug store to sell cheaper Canadian prescription drugs to (primarily) U.S. customers. The sale of these drugs is a contentious subject in Canada as well as the U.S. and as a result the industry is characterized by swift regulation changes and fierce competition. The project faced extremely volatile requirements with major changes week on week. It used very short (2-day) iterations and weekly releases to tackle the high rates of change.

As shown in Figure X3-12, high levels of buy-in and trust are evident for those who worked in an empowered way. The visual nature of the website made it easy to show new increments of functionality, but the system criticality was fairly high with essential funds for the pharmacy at stake. As mentioned, there were very high rates of change, but the small experienced team handled them well and had easy access to a knowledgeable business representative. The approach was very successful and extremely agile.

X3.5.1.2 MILITARY MESSAGING SYSTEM EXAMPLE

Contrast the first example with a large project to develop military messaging system that had already been running for 5 years when the assessment was made. See Figure X3-13.

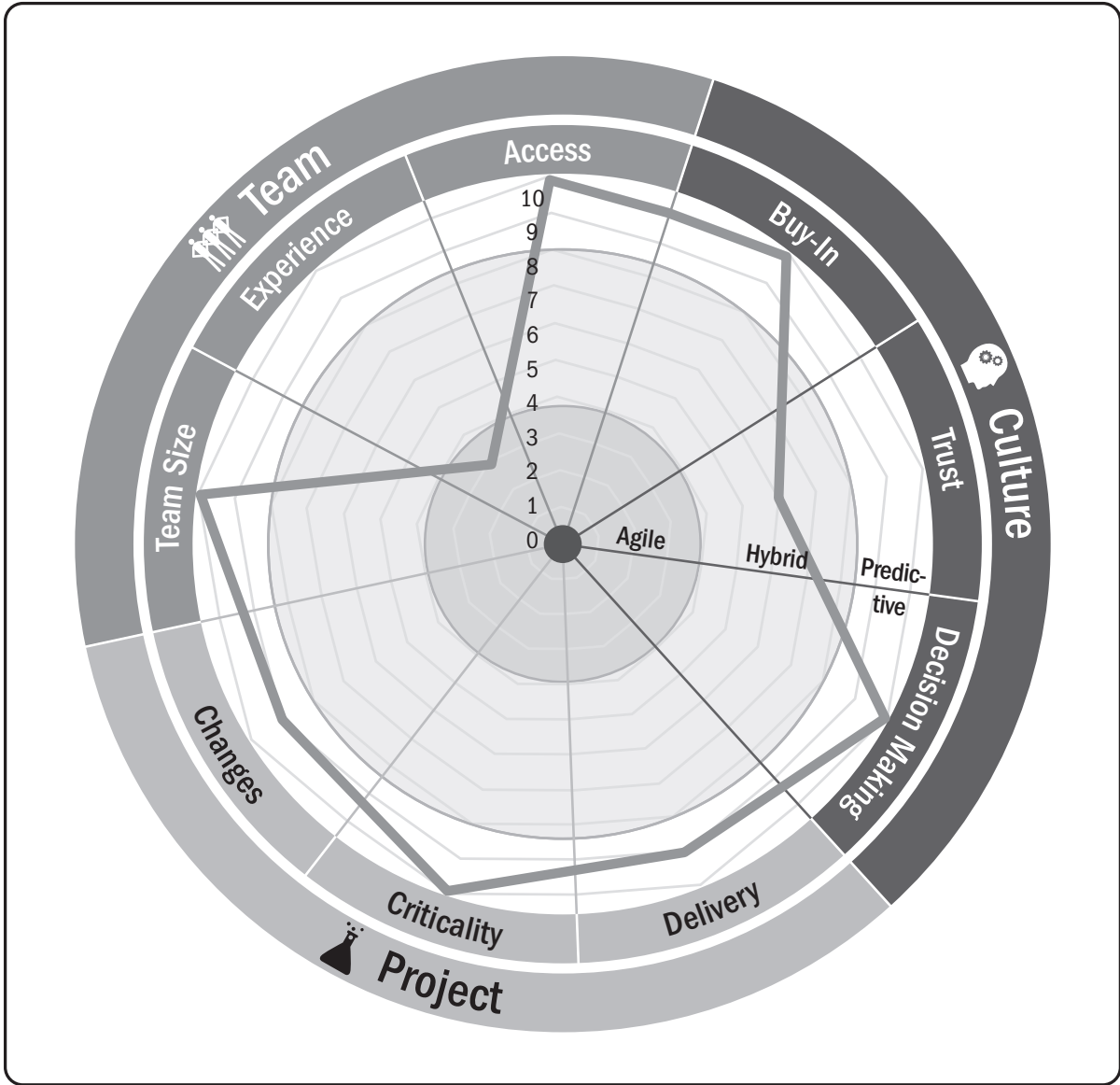

Figure X3-13. Military Messaging Example

Buy-in for an agile approach was lacking because an agile approach was not being considered. Trust in the vendors was mixed but generally respected. Decision making was not local, but instead made by architecture and requirements committees. While elements of the design could be tested incrementally in a laboratory, they could not be gathered together for an end to end demonstration of functionality. Many lives were potentially at risk, so criticality was very high. Requirements were locked down because changes impacted so many subcontractor organizations.

The project was large with more than 300 people from one vendor alone, but each role had many experienced practitioners. Finally, access to the business/customer was not possible, but contract analysts were available to ask specification questions to and they usually replied or asked clarifying questions within 10 days. Parts of the project could have been carved off and run as agile projects, but at the heart of the initiative was a single large project.

X3.6 SUMMARY

Agile suitability filters are useful tools for identifying potential fits and gaps for agile approaches. They should not be used as definitive inclusion or exclusion gates, but instead as topics for objective discussion with all interested parties.

REFERENCES

- [1] *Manifesto for Agile Software Development*. (2001). Retrieved from <http://agilemanifesto.org/>
- [2] Project Management Institute. 2013. *Managing Change in Organizations: A Practice Guide*. Newtown Square, PA: Author.
- [3] Project Management Institute. 2017. *A Guide to the Project Management Body of Knowledge (PMBOK® Guide) – Sixth Edition*. Newtown Square, PA: Author.
- [4] Project Management Institute. 2013. *Software Extension to the PMBOK® Guide Fifth Edition*. Newtown Square, PA: Author.



BIBLIOGRAPHY

The following are suggested additional reading materials, subdivided by section and/or topic:

SECTION 2—AN INTRODUCTION TO AGILE

Briggs, Sara. “Agile Based Learning: What Is It and How Can It Change Education?” *Opencolleges.edu.au* February 22, 2014, retrieved from <http://www.opencolleges.edu.au/informed/features/agile-based-learning-what-is-it-and-how-can-it-change-education/>.

Manifesto for Agile Software Development, 2001, <http://agilemanifesto.org/>.

Peha, Steve. “Agile Schools: How Technology Saves Education (Just Not the Way We Thought it Would).” InfoQ. June 28, 2011, retrieved from <https://www.infoq.com/articles/agile-schools-education>.

Principles behind the Agile Manifesto, 2001, <http://agilemanifesto.org/principles.html>.

Rothman, Johanna. 2007. *Manage It! Your Guide to Modern, Pragmatic Project Management*. Raleigh: Pragmatic Bookshelf.

Sidky, Ahmed (Keynote). 2015. <https://www.slideshare.net/AgileNZ/ahmed-sidky-keynote-agilenz>.

Stacey Complexity Model. 2016. <http://www.scrum-tips.com/2016/02/17/stacey-complexity-model/>.

SECTION 3—LIFE CYCLE SELECTION

“Agile Modeling (AM) Home Page: Effective Practices for Modeling and Documentation,” *Agile Modeling*, (n.d.), <http://www.agilemodeling.com/>

Anderson, David, and Andy Carmichael. 2016. *Essential Kanban Condensed*. Seattle: Blue Hole Press.

Anderson, David. 2010. *Kanban: Successful Evolutionary Change for Your Technology Business*. Seattle: Blue Hole Press.

- Benson, Jim, and Tonianne DeMaria Barry. 2011. *Personal Kanban: Mapping Work | Navigating Life*. Seattle: Modus Cooperandi Press.
- Burrows, Mike. 2014. *Kanban from the Inside: Understand the Kanban Method, connect it to what you already know, introduce it with impact*. Seattle: Blue Hole Press.
- Domain Driven Design Community. 2016. <http://dddcommunity.org/>.
- Gothelf, Jeff, and Josh Seiden. 2016. *Lean UX: Designing Great Products with Agile Teams*. Sebastopol: O'Reilly Media.
- Hammarberg, Marcus, and Joakim Sunden. 2014. *Kanban in Action*. Shelter Island: Manning Publications.
- "Kanban," *Wikipedia*, last modified May 4, 2017, retrieved on November 22, 2016 from <https://en.wikipedia.org/wiki/Kanban>.
- "Kanban (*development*)," *Wikipedia*, last modified May 4, 2017, retrieved on November 29, 2016 from [https://en.wikipedia.org/wiki/Kanban_\(development\)](https://en.wikipedia.org/wiki/Kanban_(development)).
- Larsen, Diana, and Ainsley Nies. 2016. *Liftoff: Start and Sustain Successful Agile Teams*. Raleigh: Pragmatic Bookshelf.
- "Learning Kanban," *Leankit*, (n.d.), <https://leankit.com/learn/learning-kanban/>.
- Leopold, Klaus, and Siegrfried Kaltenecker. 2015. *Kanban Change Leadership: Creating a Culture of Continuous Improvement*. Hoboken: Wiley.
- "Make a big impact with software products and projects!" *Impact Mapping*, (n.d.), <https://www.impactmapping.org/>.
- Patton, Jeff, and Peter Economy. 2014. *User Story Mapping: Discover the Whole Story, Build the Right Product*. Sebastopol: O'Reilly Media.
- Reinertsen, Donald. 2009. *The Principles of Product Development Flow: Second Generation Lean Product Development*. Redondo Beach: Celeritas Publishing.
- Rothman, Johanna. "Dispersed vs. Distributed Teams," *Rothman Consulting Group, Inc.*, October 25, 2010, <http://www.jrothman.com/mpd/2010/10/dispersed-vs-distributed-teams/>.
- Schwaber, Ken, and Jeff Sutherland. "The Scrum Guide™," *Scrum.org*, July 2016, <http://www.scrumguides.org/scrum-guide.html> and <http://www.scrumguides.org/docs/scrumguide/v2016/2016-Scrum-Guide-US.pdf#zoom=100>.
- Skarin, Mattias. 2015. *Real-World Kanban: Do Less, Accomplish More with Lean Thinking*. Raleigh: Pragmatic Bookshelf.
- "The High Cost of Multitasking: 40% of Productivity Lost by Task Switching," *Wrike.com*, September 24, 2015, <https://www.wrike.com/blog/high-cost-of-multitasking-for-productivity/>.
- Wells, Don. "Extreme Programming: A Gentle Introduction," *Extreme Programming*, October 8, 2013, <http://www.extremeprogramming.org/>.

SECTION 4—IMPLEMENTING AGILE:

Amabile, Teresa, and Steven Kramer. 2011. *The Progress Principle: Using Small Wins to Ignite Joy, Engagement, and Creativity at Work*. Boston: Harvard Business Review Press.

“Early Warning Signs of Project Trouble—Cheat Sheet, 2017, <https://agilevideos.com/wp-content/uploads/2017/02/WarningSignsOfProjectTrouble-CheatSheet.pdf>.

Dweck, Carol. 2006. *Mindset: The New Psychology of Success*. New York: Penguin Random House.

Kaner, Sam. *Facilitator’s Guide to Participatory Decision-Making*. 3rd ed. 2014. San Francisco: Jossey-Bass.

Keith, Kent. *The Case for Servant Leadership*. 2008. Westfield: Greenleaf Center for Servant Leadership.

Rothman, Johanna. 2016. *Agile and Lean Program Management: Scaling Collaboration Across the Organization*. Victoria, British Columbia: Practical Ink.

Rothman, Johanna. “Dispersed vs. Distributed Teams,” *Rothman Consulting Group, Inc.*, October 25, 2010, <http://www.jrothman.com/mpd/2010/10/dispersed-vs-distributed-teams/>.

Rothman, Johanna. 2007. *Manage It! Your Guide to Modern, Pragmatic Project Management*. Raleigh: Pragmatic Bookshelf.

Rothman, Johanna. 2016. *Manage Your Project Portfolio: Increase Your Capacity and Finish More Projects*. Raleigh: Pragmatic Bookshelf.

Schwaber, Ken, and Jeff Sutherland. “The Scrum Guide™,” *Scrum.org*, July 2016, <http://www.scrumguides.org/scrum-guide.html> and <http://www.scrumguides.org/docs/scrumguide/v2016/2016-Scrum-Guide-US.pdf#zoom=100>.

Sinek, Simon. 2011. *Start with Why: How Great Leaders Inspire Everyone to Take Action*. New York: Portfolio, Penguin Random House.

“The High Cost of Multitasking: 40% of Productivity Lost by Task Switching,” *Wrike.com*, September 24, 2015, <https://www.wrike.com/blog/high-cost-of-multitasking-for-productivity/>.

EXPERIENCE REPORTS:

“Experience Reports,” *Agile Alliance*, (n.d.), <https://www.agilealliance.org/resources/experience-reports/>.

PROJECT AND TEAM HEALTH:

“Early Warning Signs of Project Trouble—Cheat Sheet.” 2017. <https://agilevideos.com/wp-content/uploads/2017/02/WarningSignsOfProjectTrouble-CheatSheet.pdf>

“TeamHealth Radar – Summary View,” *Agilehealth*. 2014. <http://agilityhealthradar.com/wp-content/uploads/2014/11/bigradar.gif>.

RESOURCE EFFICIENCY:

Modig, Niklas, and Pär Åhlström. 2015. *This is Lean: Resolving the Efficiency Paradox*. London: Rheologica Publishing.

Rothman, Johanna. "Resource Efficiency vs. Flow Efficiency, Part 5: How Flow Changes Everything," *Rothman Consulting Group, Inc.*, September 20, 2015, <http://www.jrothman.com/mpd/agile/2015/09/resource-efficiency-vs-flow-efficiency-part-5-how-flow-changes-everything/>.

SCALING:

Disciplined Agile 2.X—A Process Decision Framework. 2016. <http://www.disciplinedagiledelivery.com/>.

Kniberg, Henrik. "Scaling Agile @ Spotify with Tribes, Squads, Chapters & Guilds," *Crisp*, November 14, 2012, <http://blog.crisp.se/2012/11/14/henrikkniberg/scaling-agile-at-spotify>.

"Overview—Large Scale Scrum," *LeSS*. 2016. <http://less.works/>.

"SAFe® for Lean Software and System Engineering," *SAFe®*. 2016. <http://www.scaledagileframework.com/>.

SKILLS:

Beck, Kent. *Paint Drip People*, August 4, 2016, <https://www.facebook.com/notes/kent-beck/paint-drip-people/122670000696195/>.

"Generalizing Specialists: Improving Your IT Career Skills," *Agile Modeling*, (n.d.), <http://www.agilemodeling.com/essays/generalizingSpecialists.htm>.

Hunter, Brittany. "Of Software Designers & Broken Combs," *Atomic Object*, June 27, 2013, <https://spin.atomicobject.com/2013/06/27/broken-comb-people/>.

SECTION 5—IMPLEMENTING AGILE: DELIVERING IN AN AGILE ENVIRONMENT

Larsen, Diana, and Ainsley Nies. 2016. *Liftoff: Start and Sustain Successful Agile Teams*. Raleigh: Pragmatic Bookshelf.

RETROSPECTIVES:

Derby, Esther, and Diana Larsen. 2006. *Agile Retrospectives: Making Good Teams Great*. Raleigh: Pragmatic Bookshelf.

Gonçalves, Luis, and Ben Linders. 2015. *Getting Value out of Agile Retrospectives: A Toolbox of Retrospective Exercises*. Victoria, British Columbia: Leanpub.

BACKLOG:

Adzic, Gojko, Marjory Bissett, and Tom Poppendieck. 2012. *Impact Mapping: Making a Big Impact with Software Products and Projects*. Woking, Surrey: Provoking Thoughts.

Patton, Jeff, and Peter Economy. 2014. *User Story Mapping: Discover the Whole Story, Build the Right Product*. Sebastopol: O'Reilly Media.

Rothman, Johanna. "We Need Planning; Do We Need Estimation?" *Rothman Consulting Group, Inc.*, January 21, 2015, <http://www.jrothman.com/mpd/project-management/2015/01/we-need-planning-do-we-need-estimation/>.

STANDUPS:

Brodzinski, Pawel. "Effective Standups around Kanban Board," *Brodzinski.com*, December 30, 2011, <http://brodzinski.com/2011/12/effective-standups.html>.

Fowler, Martin. "It's Not Just Standing Up: Patterns for Daily Standup Meetings," *Martinfowler.com*, February 21, 2016, <http://martinfowler.com/articles/itsNotJustStandingUp.html>.

Hefley, Chris. "How to Run Effective Standups and Retrospectives," *Leankit*, September 15, 2014, <https://leankit.com/blog/2014/09/run-effective-standups-retrospectives/>.

EARNED VALUE:

Griffiths, Mike. "A Better S Curve and Simplified EVM," *Leading Answers*, June 6, 2008, http://leadinganswers.typepad.com/leading_answers/2008/06/a-better-s-curve-and-simplified-evm.html.

SECTION 6—ORGANIZATIONAL CONSIDERATIONS FOR AGILE PROJECTS

Bankston, Arlen, and Sanjiv Augustine. *Agile Team Performance Management: Realizing the Human Potential of Teams*, June 14, 2010, www.lithespeed.com/transfer/Agile-Performance-Management.pptx.

Browder, Justin, and Brian Schoeff. *Perfect Strangers: How Project Managers and Developers Relate and Succeed*. CreateSpace Independent Publishing Platform, 2016, <https://www.createspace.com/>.

Griffiths, Mike. "Agile Talent Management," *Leading Answers*, October 14, 2015, http://leadinganswers.typepad.com/leading_answers/2015/10/agile-talent-management.html.

Kohn, Alfie. 1999. *Punished by Rewards: The Trouble with Gold Stars, Incentive Plans, A's, Praise, and Other Bribes*. New York: Mariner Books.

Mar, Kane. "How to do Agile Performance Reviews," *Scrumology*, (n.d.), <https://scrumology.com/how-to-do-agile-performance-reviews/>.

McChrystal, Stanley, Tatum Collins, David Silverman, and Chris Fussell. 2015. *Team of Teams: New Rules of Engagement for a Complex World*. New York: Portfolio, Penguin Random House.

Pink, Daniel. 2011. *Drive: The Surprising Truth About What Motivates Us*. New York: Riverhead Books.

SECTION 7—A CALL TO ACTION (INSPECTION WITHOUT ADAPTATION IS FUTILE)

Dennis, Pascal. 2006. *Getting the Right Things Done: A Leader's Guide to Planning and Execution*. Cambridge: Lean Enterprise Institute.

Griffiths, Mike. "Introducing Agile Methods: Mistakes to Avoid—Part 3," *Leading Answers*, March 15, 2007, http://leadinganswers.typepad.com/leading_answers/2007/03/introducing_agi_2.html.

Little, Jason. *Lean Change Management: Innovative Practices for Managing Organizational Change*. Happy Melly Express, 2014, <http://www.happymelly.com/category/hm-express/>.

Rising, Linda, and Mary Lynne Manns. 2004. *Fearless Change: Patterns for Introducing New Ideas*. Upper Saddle River: Addison-Wesley Professional.

"The IDEAL Model," *Software Engineering Institute, Carnegie Mellon*, 2006, <http://www.sei.cmu.edu/library/assets/idealmodel.pdf>.

ANNEX A1—PMBOK® GUIDE MAPPING

Larsen, Diana and Ainsley Nies. 2016. *Liftoff: Start and Sustain Successful Agile Teams*. Raleigh: Pragmatic Bookshelf.

ANNEX A2—AGILE MANIFESTO MAPPING

Manifesto for Agile Software Development, 2001, <http://agilemanifesto.org/>.

Principles behind the Agile Manifesto, 2001, <http://agilemanifesto.org/principles.html>.

ANNEX A3—OVERVIEW OF AGILE AND LEAN FRAMEWORKS

Agile Business Consortium, 2014, <https://www.agilebusiness.org/what-is-dsdm>.

Ambler, Scott. "The Agile Unified Process," *Ambysoft*, May 13, 2006, <http://www.ambysoft.com/unifiedprocess/agileUP.html>.

Anderson, David. 2010. *Kanban: Successful Evolutionary Change for Your Technology Business*. Seattle: Blue Hole Press.

Beedle, Mike. *Enterprise Scrum: Executive Summary: Business Agility for the 21st Century*, January 7, 2017, <http://www.enterprisescrum.com/enterprise-scrum/>.

Cockburn, Alistair. 2004. *Crystal Clear: A Human-Powered Methodology for Small Teams*. Upper Saddle River: Pearson Education.

Cockburn, Alistair. "Crystal Methodologies," *alistair.cockburn.us*, March 28, 2014, <http://alistair.cockburn.us/Crystal+methodologies>.

Disciplined Agile 2.X—A Process Decision Framework, 2016, <http://www.disciplinedagiledelivery.com/>.

Joint MIT-PMI-INCOSE Community of Practice on Lean in Program Management. 2012. *The Guide to Lean Enablers for Managing Engineering Programs*. Newtown Square, PA: Author.

"Kanban," *Wikipedia*, last modified May 4, 2017, retrieved on November 22, 2016 from <https://en.wikipedia.org/wiki/Kanban>.

"Kanban (development)," *Wikipedia*, last modified May 4, 2017, retrieved on November 29, 2016 from [https://en.wikipedia.org/wiki/Kanban_\(development\)](https://en.wikipedia.org/wiki/Kanban_(development)).

Reddy, Ajay, and Jack Speranza. 2015. *The Scrumban [R]Evolution: Getting the Most Out of Agile, Scrum, and Lean Kanban*. Boston: Addison-Wesley Professional.

"Overview—Large Scale Scrum," *LeSS*, 2016, <http://less.works/>.

"SAFe® for Lean Software and System Engineering," *SAFe®*, 2016, <http://www.scaledagileframework.com/>.

Schwaber, Ken, and Jeff Sutherland. "The Scrum Guide™," *Scrum.org*, July 2016, <http://www.scrumguides.org/scrum-guide.html> and <http://www.scrumguides.org/docs/scrumguide/v2016/2016-Scrum-Guide-US.pdf#zoom=100>.

"Scrum of Scrums," *Agile Alliance*, (n.d.), <https://www.agilealliance.org/glossary/scrum-of-scrums/>.

"Scrumban," *Wikipedia*, March 2, 2017, <https://en.wikipedia.org/wiki/Scrumban>.

"State of Agile Report: Agile Trends," *VersionOne*, 2017, <http://stateofagile.versionone.com/>.

Sutherland Jeff. "Agile Can Scale: Inventing and Reinventing SCRUM in Five Companies." *Cutter IT Journal* 14, no. 12 (2001): 5–11. http://www.controlchaos.com/storage/scrum-articles/Sutherland_200111_proof.pdf.

"The 2015 State of Agile Development," *Scrum Alliance®*, 2015, <https://www.forrester.com/report/The+2015+State+Of+Agile+Development/-/E-RES122910>

Wells, Don. "Extreme Programming: A Gentle Introduction," *Extreme Programming*, October 8, 2013, <http://www.extremeprogramming.org/>.

Why Scrum? State of Scrum Report, 2016, <https://www.scrumalliance.org/why-scrum/state-of-scrum-report/2016-state-of-scrum>.

APPENDIX X2—ATTRIBUTES THAT INFLUENCE TAILORING

Griffiths, Mike. "Agile Suitability Filters," *Leading Answers*, 2007, http://leadinganswers.typepad.com/leading_answers/files/agile_suitability_filters.pdf.

Jeffries, Ron. "We Tried Baseball and It Didn't Work," *ronjeffries.com*, May 2, 2006, <http://ronjeffries.com/xprog/articles/jatbaseball/>.

Rothman, Johanna. "One Experimental Possibility: Self-Organization from Component Teams to Feature Teams," *Rothman Consulting Group, Inc.*, September 23, 2014, <http://www.jrothman.com/mpd/agile/2014/09/one-experimental-possibility-self-organization-from-component-teams-to-feature-teams/>.

GLOSSARY

1. ACRONYMS

ATDD	acceptance test-driven development
BDD	behavior-driven development
BRD	business requirement documents
DA	Disciplined Agile
DoD	definition of done
DoR	definition of ready
DSDM	Dynamic Systems Development Method
Evo	evolutionary value delivery
LeSS	Large-Scale Scrum
LSD	Lean Software Development
PDCA	Plan-Do-Check-Act
PMO	project management office
ROI	return on investment
RUP	rational unified process
SAFe®	Scaled Agile Framework®
SBE	specification by example
XP	eXtreme Programming

2. DEFINITIONS

A3. A way of thinking and a systematic problem-solving process that collects the pertinent information on a single A3-size sheet of paper.

Acceptance Test-Driven Development (ATDD). A method of collaboratively creating acceptance test criteria that are used to create acceptance tests before delivery begins.

Agile. A term used to describe a mindset of values and principles as set forth in the Agile Manifesto.

Agile Coach. An individual with knowledge and experience in agile who can train, mentor, and guide organizations and teams through their transformation.

Agile Life Cycle. An approach that is both iterative and incremental to refine work items and deliver frequently.

Agile Manifesto. The original and official definition of agile values and principles.

Agile Mindset. A way of thinking and behaving underpinned by the four values and twelve principles of the Agile Manifesto.

Agile Practitioner. A person embracing the agile mindset who collaborates with like-minded colleagues in cross-functional teams. Also referred to as agilist.

Agile Principles. The twelve principles of agile project delivery as embodied in the Agile Manifesto.

Agile Unified Process. A simplistic and understandable approach to developing business application software using agile techniques and concepts. It is a simplified version of the Rational Unified Process (RUP).

Agilist. See *Agile Practitioner*.

Anti-Pattern. A known, flawed pattern of work that is not advisable.

Automated Code Quality Analysis. The scripted testing of code base for bugs and vulnerabilities.

Backlog. See *Product Backlog*.

Backlog Refinement. The progressive elaboration of project requirements and/or the ongoing activity in which the team collaboratively reviews, updates, and writes requirements to satisfy the need of the customer request.

Behavior-Driven Development (BDD). A system design and validation practice that uses test-first principles and English-like scripts.

Blended Agile. Two or more agile frameworks, methods, elements, or practices used together such as Scrum practiced in combination with XP and Kanban Method.

Blocker. See *Impediment*.

Broken Comb. Refers to a person with various depths of specialization in multiple skills required by the team. Also known as Paint Drip. See also *T-shaped* and *I-shaped*.

Burndown Chart. A graphical representation of the work remaining versus the time left in a timebox.

Burnup Chart. A graphical representation of the work completed toward the release of a product.

Business Requirement Documents (BRD). Listing of all requirements for a specific project.

Cadence. A rhythm of execution. See also *Timebox*.

Collective Code Ownership. A project acceleration and collaboration technique whereby any team member is authorized to modify any project work product or deliverable, thus emphasizing team-wide ownership and accountability.

Continuous Delivery. The practice of delivering feature increments immediately to customers, often through the use of small batches of work and automation technology.

Continuous Integration. A practice in which each team member's work products are frequently integrated and validated with one another.

Cross-Functional Team. A team that includes practitioners with all the skills necessary to deliver valuable product increments.

Crystal Family of Methodologies. A collection of lightweight agile software development methods focused on adaptability to a particular circumstance.

Daily Scrum. A brief, daily collaboration meeting in which the team reviews progress from the previous day, declares intentions for the current day, and highlights any obstacles encountered or anticipated. Also known as daily standup.

Definition of Done (DoD). A team's checklist of all the criteria required to be met so that a deliverable can be considered ready for customer use.

Definition of Ready (DoR). A team's checklist for a user-centric requirement that has all the information the team needs to be able to begin working on it.

DevOps. A collection of practices for creating a smooth flow of delivery by improving collaboration between development and operations staff.

Disciplined Agile (DA). A process decision framework that enables simplified process decisions around incremental and iterative solution delivery.

Double Loop Learning. A process that challenges underlying values and assumptions in order to better elaborate root causes and devise improved countermeasures rather than focusing only on symptoms.

Dynamic Systems Development Method (DSDM). An agile project delivery framework.

Evolutionary Value Delivery (EVO). Openly credited as the first agile method that contains a specific component no other methods have: the focus on delivering multiple measurable value requirements to stakeholders.

eXtreme Programming. An agile software development method that leads to higher quality software, a greater responsiveness to changing customer requirements, and more frequent releases in shorter cycles.

Feature-Driven Development. A lightweight agile software development method driven from the perspective of features valued by clients.

Fit for Purpose. A product that is suitable for its intended purpose.

Fit for Use. A product that is usable in its current form to achieve its intended purpose.

Flow Master. The coach for a team and service request manager working in a continuous flow or Kanban context. Equivalent to *Scrum Master*.

Framework. A basic system or structure of ideas or facts that support an approach.

Functional Requirement. A specific behavior that a product or service should perform.

Functional Specification. A specific function that a system or application is required to perform. Typically represented in a functional specifications document.

Hoshin Kanri. A strategy or policy deployment method.

Hybrid Approach. A combination of two or more agile and non-agile elements, having a non-agile end result.

IDEAL. An organizational improvement model that is named for the five phases it describes: initiating, diagnosing, establishing, acting, and learning.

Impact Mapping. A strategic planning technique that acts as a roadmap to the organization while building new products.

Impediment. An obstacle that prevents the team from achieving its objectives. Also known as a blocker.

Increment. A functional, tested, and accepted deliverable that is a subset of the overall project outcome.

Incremental Life Cycle. An approach that provides finished deliverables that the customer may be able to use immediately.

Information Radiator. A visible, physical display that provides information to the rest of the organization enabling up-to-the-minute knowledge sharing without having to disturb the team.

I-shaped. Refers to a person with a single deep area of specialization and no interest or skill in the rest of the skills required by the team. See also *T-Shaped* and *Broken Comb*.

Iteration. A timeboxed cycle of development on a product or deliverable in which all of the work that is needed to deliver value is performed.

Iterative Life Cycle. An approach that allows feedback for unfinished work to improve and modify that work.

Kaizen Events. Events aimed at improvement of the system.

Kanban Board. A visualization tool that enables improvements to the flow of work by making bottlenecks and work quantities visible.

Kanban Method. An agile method inspired by the original Kanban inventory control system and used specifically for knowledge work.

Large Scale Scrum (LeSS). Large-Scale Scrum is a product development framework that extends Scrum with scaling guidelines while preserving the original purposes of Scrum.

Lean Software Development (LSD). Lean software development is an adaptation of lean manufacturing principles and practices to the software development domain and is based on a set of principles and practices for achieving quality, speed, and customer alignment.

Life Cycle. The process through which a product is imagined, created, and put into use.

Mobbing. A technique in which multiple team members focus simultaneously and coordinate their contributions on a particular work item.

Organizational Bias. The preferences of an organization on a set of scales characterized by the following core values: exploration versus execution, speed versus stability, quantity versus quality, and flexibility versus predictability.

Organizational Change Management. A comprehensive, cyclic, and structured approach for transitioning individuals, groups, and organizations from the current state to a future state with intended business benefits.

Paint-Drip. See *Broken Comb*.

Pairing. See *Pair Work*.

Pair Programming. Pair work that is focused on programming.

Pair Work. A technique of pairing two team members to work simultaneously on the same work item.

Personas. An archetype user representing a set of similar end users described with their goals, motivations, and representative personal characteristics.

Pivot. A planned course correction designed to test a new hypothesis about the product or strategy.

Plan-Do-Check-Act (PDCA). An iterative management method used in organizations to facilitate the control and continual improvement of processes and products.

Plan-Driven Approach. See *Predictive Approach*.

Predictive Approach. An approach to work management that utilizes a work plan and management of that work plan throughout the life cycle of a project.

Predictive Life Cycle. A more traditional approach, with the bulk of planning occurring up-front, then executing in a single pass; a sequential process.

Project Management Office (PMO). A management structure that standardizes the project-related governance processes and facilitates the sharing of resources, methodologies, tools, and techniques.

Product Backlog. An ordered list of user-centric requirements that a team maintains for a product.

Product Owner. A person responsible for maximizing the value of the product and who is ultimately responsible and accountable for the end product that is built. See also *Service Request Manager*.

Progressive Elaboration. The iterative process of increasing the level of detail in a project management plan as greater amounts of information and more accurate estimates become available.

Refactoring. A product quality technique whereby the design of a product is improved by enhancing its maintainability and other desired attributes without altering its expected behavior.

Retrospective. A regularly occurring workshop in which participants explore their work and results in order to improve both process and product.

Rolling Wave Planning. An iterative planning technique in which the work to be accomplished in the near term is planned in detail, while the work in the future is planned at a higher level.

Scaled Agile Framework (SAFe®). A knowledge base of integrated patterns for enterprise-scale lean–agile development.

Scrum. An agile framework for developing and sustaining complex products, with specific roles, events, and artifacts.

Scrumban. A management framework that emerges when teams employ Scrum as the chosen way of working and use the Kanban Method as a lens through which to view, understand, and continuously improve how they work.

Scrum Board. An information radiator that is utilized to manage the product and sprint backlogs and show the flow of work and its bottlenecks.

Scrum Master. The coach of the development team and process owner in the Scrum framework. Removes obstacles, facilitates productive events and defends the team from disruptions. See also *Flow Master*.

Scrum of Scrums. A technique to operate Scrum at scale for multiple teams working on the same product, coordinating discussions of progress on their interdependencies, and focusing on how to integrate the delivery of software, especially in areas of overlap.

Scrum Team. Describes the combination of development team, scrum master, and process owner used in Scrum.

Self-Organizing Team. A cross-functional team in which people fluidly assume leadership as needed to achieve the team's objectives.

Servant Leadership. The practice of leading through service to the team, by focusing on understanding and addressing the needs and development of team members in order to enable the highest possible team performance.

Service Request Manager. The person responsible for ordering service requests to maximize value in a continuous flow or Kanban environment. Equivalent to product owner.

Siloed Organization. An organization structured in such a way that it only manages to contribute a subset of the aspects required for delivering value to customers. For contrast, see *Value Stream*.

Single Loop Learning. The practice of attempting to solve problems by just using specific predefined methods, without challenging the methods in light of experience.

Smoke Testing. The practice of using a lightweight set of tests to ensure that the most important functions of the system under development work as intended.

Specification by Example (SBE). A collaborative approach to defining requirements and business-oriented functional tests for software products based on capturing and illustrating requirements using realistic examples instead of abstract statements.

Spike. A short time interval within a project, usually of fixed length, during which a team conducts research or prototypes an aspect of a solution to prove its viability.

Sprint. Describes a timeboxed iteration in Scrum.

Sprint Backlog. A list of work items identified by the Scrum team to be completed during the Scrum sprint.

Sprint Planning. A collaborative event in Scrum in which the Scrum team plans the work for the current sprint.

Story Point. A unit-less measure used in relative user story estimation techniques.

Swarming. A technique in which multiple team members focus collectively on resolving a specific impediment.

Technical Debt. The deferred cost of work not done at an earlier point in the product life cycle.

Test-Driven Development. A technique where tests are defined before work is begun, so that work in progress is validated continuously, enabling work with a zero defect mindset.

Timebox. A fixed period of time, for example, 1 week, 1 fortnight, 3 weeks, or 1 month. See also *Iteration*.

T-shaped. Refers to a person with one deep area of specialization and broad ability in the rest of the skills required by the team. See also *I-Shaped* and *Broken Comb*.

User Story. A brief description of deliverable value for a specific user. It is a promise for a conversation to clarify details.

User Story Mapping. A visual practice for organizing work into a useful model to help understand the sets of high-value features to be created over time, identify omissions in the backlog, and effectively plan releases that deliver value to users.

UX Design. The process of enhancing the user experience by focusing on improving the usability and accessibility to be found in the interaction between the user and the product.

Value Stream. An organizational construct that focuses on the flow of value to customers through the delivery of specific products or services.

Value Stream Mapping. A lean enterprise technique used to document, analyze, and improve the flow of information or materials required to produce a product or service for a customer.



INDEX

A

A3, 150

Accelerated delivery, changes associated with, 73

Acceptance criteria

execution practices and, 56

iterations and, 63

Acceptance test-driven development (ATDD)

defined, 150

value delivery and, 56

Acceptance testing, 82

Accumulating work, 70

Action items, 51

Adaptation

delivering value and, 87

processes and, 15, 28

Agile

adoption of, 87

defined, 150

implementation of, 33–47

popularization of term, 10

various approaches and, 11

Agile Alliance, 1, 43

Agile approach(es)

components of, 10

mixing, 31

predictive approach combined with, 27

predictive component and, 28

transitioning to, 73

Agile-based learning, 2

Agile coach, 150

Agile environment, creation of, 33–47

Agile life cycle(s)

Agile Manifesto and, 25

characteristics of, 24–25

continuum of life cycles and, 19

defined, 150

flow-based, 24

iteration-based, 24

Agile Manifesto

agile life cycles and, 25

core tenets, 38

defined, 150

mindset and, 8–12

practices and, 10

principles of, 9, 10, 50

publication of, 87

values of, 2, 8, 10, 35, 77

Agile methods

frameworks and, 11, 80

Kanban Method and, 12

Agile mindset

Agile Manifesto and, 8–12, 10

customer-collaboration, 81

defined, 150

siloeed organizations and, 47

speed of change and, 3

starting with, 33

universal application of, 87

Agile PMO. *See* Project management office

Agile practices, 50–57

Agile practitioner

defined, 150

project manager role and, 37

- Agile principles
 - agile-based learning and, 2
 - cross-functional teams and, 43
 - defined, 150
 - readiness for change and, 73
- Agile roles, 40–41
- Agile suitability filters, 25
- Agile teams
 - attributes of successful, 39–40
 - roles in, 40–41
- Agile unified process, 150
- Agilist. *See* Agile practitioner
- Anti-pattern(s)
 - defined, 150
 - standups and, 55
- Approach(es)
 - blending of, 31
 - term use in guide, 11
- ATDD. *See* Acceptance test-driven development
- Automated code quality analysis, 150
- Automated testing, 31, 56
- Automation, 7

B

- Backlog. *See* Product backlog
- Backlog refinement, 52–53
 - conducting meetings for, 53
 - defined, 150
 - refinement length and, 52
- Baselines, 61
- Basics, 1–5
 - agile-based learning and, 2
 - development of guide, 1
 - disruptive technologies and, 3
 - organization of guide, 5
 - reason for guide, 2
 - in-scope/out-of-scope items, 4
- Batch sizes, 42
- BDD. *See* Behavior-driven development
- Behavior-driven development (BDD)
 - defined, 150
 - value delivery and, 56
- Big Dig, Boston, 15
- Blended agile, 150

- Blending of approaches, 31
- Blocker. *See* Impediment
- Boston Big Dig, 15
- Bottlenecks, 35, 42, 64
- BRD. *See* Business requirement documents
- Broken comb, 150
- Budgeting, incremental, 36
- Burndown chart
 - defined, 150
 - feature charts and, 67
 - story points and, 62
- Burnup chart
 - defined, 150
 - earned value and, 68–69
 - feature charts and, 67
 - product backlog, 68
 - scope changes and, 64
 - story points and, 63
- Business practices, 79
- Business requirement documents (BRD), 150
- Business satisfaction, 60
- Business service. *See* Service(s)
- Business value delivery, 16, 23, 29

C

- Cadence
 - defined, 151
 - working product delivery and, 57
- Call to action, 87
- Cancellation option, contracts and, 78
- Capacity measures
 - iteration-based agile and, 55
 - in-the-moment measurements and, 66
 - story points and, 66
- Change(s). *See also* Uncertainty
 - accelerated delivery and, 73
 - agile approaches and, 73
 - kanban board and, 85
 - readiness for, 73–74
 - requirements and, 24
 - roadblocks to, 74
 - safety and, 75
 - speed of, agile mindset and, 3
- Change control boards, 35

- Change management. *See* Organizational change management
 - Change request process, 7, 8–12
 - Charter, project, 49–50
 - Cloud computing, 3
 - Coaching, 38, 55
 - Collaboration
 - chartering process and, 49
 - cross-department, 73
 - customer-collaboration mindset, 81
 - expedited work and, 39
 - facilitation of, 35, 38
 - good will and, 37
 - shared risk-reward relationship, 77
 - transparency and, 79
 - Collective code ownership, 151
 - Collocated teams, 39, 43, 44, 45
 - Communication
 - dispersed teams and, 46
 - facilitators and, 35
 - Competencies
 - internal, 83
 - PMO and, 82
 - roadblocks and, 74
 - Completeness
 - subjective nature of, 23
 - working agreements and, 50
 - Complexity. *See also* Stacey Complexity Model
 - high-change projects and, 38
 - hybrid life cycles and, 26
 - iterative life cycles and, 21
 - troubleshooting and, 57
 - uncertainty and, 7, 13
 - Constraints, 20, 31, 42
 - Context switching, 44, 45
 - Continuous delivery, 151
 - Continuous integration
 - blending approaches and, 31
 - defined, 151
 - value delivery and, 56
 - Continuous learning, 73
 - Contracting techniques, 77–79
 - dynamic scope option, 78
 - early cancellation option, 78
 - fixed-price increments, 77
 - full-service suppliers, 79
 - graduated time and materials, 78
 - multi-tiered structure, 77
 - not-to-exceed time and materials, 78
 - team augmentation, 76
 - value delivered and, 77
 - Coordination
 - multi-team, 80
 - servant leadership and, 35
 - Cost performance index (CPI), 69
 - CPI. *See* Cost performance index
 - Cross-functional team(s)
 - agile principles and, 43
 - business practices and, 79
 - defined, 151
 - functional product increments and, 39
 - high-change projects and, 38
 - product development and, 43
 - project leadership and, 47
 - role, agile team member, 41
 - Scrum framework and, 31
 - servant leadership and, 33
 - Crystal family of methodologies, 151
 - Culture. *See* Organizational culture
 - Cumulative flow diagram, 70, 82
 - Customer-collaboration mindset, 81
 - Customer feedback loops, 2
 - Customer requirements. *See* Requirements
 - Customer satisfaction, 2, 25
 - Customer-supplier relationship, breakdowns in, 77
 - Customer value. *See* Value
 - Cycle time
 - external dependencies and, 66
 - flow-based agile teams and, 64
 - lead time and, 66
- ## D
- DA. *See* Disciplined Agile
 - Daily Scrum, 151
 - Daily standups, 27, 44, 53–54
 - antipatterns and, 54
 - flow-based agile, 54
 - iteration-based agile, 53
 - Dedicated team members, 44–45

Definable work projects, 7
Definition of done (DoD), 151
Definition of ready (DoR), 151
Delays, 64
Deliverables. *See also* Service(s)
 interim, 15
 microdeliverables, 77
 reduction of project size, 83
 requirements and
 value-driven, 77
Deliveries. *See also* Business value delivery
 accelerated, 73
 customer-based, 29
 frequent, 55
 iterations, increments and, 57
 subjective nature of, 23
 work in progress and, 70
Delivery teams, 35
Demonstrations
 deliveries and, 57
 reviews and, 55
Dependencies, multi-team coordination and, 80
DevOps, 151
Disciplined Agile (DA), 151
Dispersed teams, 43, 44, 45
Disruptive technologies, 2, 3
Distributed teams, 43
DoD. *See* Definition of done
DoR. *See* Definition of ready
Double loop learning, 151
DSDM. *See* Dynamic Systems Development Method
Dynamic scope contracting approach, 78
Dynamic Systems Development Method (DSDM), 151

E

Early cancellation option, contracts and, 78
Earned value (EV), 61
 finished features and, 67–68
 measurement of, 68–69
Emotional intelligence, 36
Estimation
 relative, 67
 upfront, 27
EV. *See* Earned Value

EVM metrics, traditional, 69
EVO. *See* Evolutionary value delivery
Evolutionary value delivery (EVO), 151
Execution practices, 56
Expectations, setting, 45
 eXtreme Programming (XP)
 blending approaches and, 31
 collaboration and, 80
 defined, 151
 value delivery and, 56

F

Face-to-face pairing, 46
Facilitators, 35, 51
Failures, project, 77
FDA approval process, 26
Feature burnup/burndown charts, 67
Feature charts, 67
Feature delivery. *See* Deliveries
Feature-Driven Development, 151
Feedback
 agile teams and, 39, 42
 demonstrations and, 55
 incorporation of, 43
 iterations and, 57
 planning and, 29
 prototypes and, 22, 23
 waste, rework and, 15
Feedback loops, 2, 15
Finished work. *See* Value
Fishbowl windows, 46
Fit, tailoring options to improve, 32
Fit for purpose
 defined, 151
 hybrid life cycles and, 29
Fit for use, 151
Fixed-price microdeliverables, 77
Flow-based agile life cycle
 iteration-based agile compared to, 24, 25
 standups and, 54
Flow diagram, cumulative, 70, 82
Flow efficiency, 42
Flow master, 151
“Follow the sun” development practice, 44

Framework(s)
 agile methods, 80
 defined, 151
Functionalized structures, 83
Functional requirement, 152
Functional specification, 152

G

Generalizing specialists, 42
Geographically distributed project organizations, 83
Geographically distributed teams, 46
Ground rules, 50
Group norms, 50
Guide basics. *See* Basics
Guide to the Project Management Body of Knowledge, A.
See PMBOK Guide

H

High-change projects, 38
High-uncertainty projects, 7
Hoshin Kanri, 152
Human resources, 79, 82
Hybrid approach, 27, 152
Hybrid life cycle(s)
 characteristics of, 26–27
 example of, 26
 as fit-for-purpose, 29
 as transition strategy, 30

I

IDEAL, 152
Impact mapping
 defined, 152
 product owner and, 52
Impediment(s)
 defined, 152
 servant leaders and, 35
Increment(s), working product delivery and, 57
Incremental initiatives, 20
Incremental life cycle(s)
 characteristics of, 22–23
 continuum of life cycles and, 19
 defined, 152
 varying-sized increments and, 22

Information radiator, 152
In-scope items, 4
Inspection, delivering value and, 87
Insurance underwriting system, 29
Integration. *See* Continuous integration
Interim deliverables, 15
Internal processes, evolving, 73
Interpersonal skills, 36
Intrapreneur approach, PMO and, 81
I-shaped, 42, 152
Iteration(s)
 defined, 152
 story points and, 61, 64
 velocity and, 64
 working product delivery and, 57
Iteration-based agile
 burndown charts and, 62
 flow-based agile compared to, 24, 25
 planning for, 55
 standups and, 53
Iterative life cycle(s)
 characteristics of, 21–22
 continuum of life cycles and, 19
 defined, 152
 single product delivery, 21

K

Kaizen events, 152
Kanban, “walking” the, 53
Kanban board
 backlog for changes, ranked, 85
 blending approaches and, 31
 defined, 152
 example of, 65
 progress of work and, 86
Kanban Method, 16, 152
 blending approaches and, 31
 emergence of, 12
 Lean and, 12–13
 lean approach and, 11
Knowledge, product, 83

L

Large-Scale Scrum (LeSS), 152

Leadership. *See* Servant leadership

Lead time

- cycle time and, 66

- external dependencies and, 66

- flow-based agile teams and, 64

Lean

- Agile approach and, 11

- Kanban Method and, 12–13

Lean Software Development (LSD), 152

Lean thinking, 11, 12

Learning

- continuous, 73

- organizational, 82

- value and, 61–62

LeSS. *See* Large-Scale Scrum

Life cycle(s). *See also* Agile life cycle(s); Hybrid life cycle(s); Incremental life cycle(s); Iterative life cycle(s); Predictive life cycle(s)

- characteristics of, 18

- continuum of, 19

- defined, 152

- planning and, 20

- selection of

- types of, 17

LSD. *See* Lean Software Development

M

Managing Change in Organizations: A Practice Guide, 3, 71

Manifesto. *See* Agile Manifesto

Manifesto for Agile Software Development, 8

Measurements

- Agile projects and, 60–70

- baselines and, 61

- capacity, 66

- earned value and, 68–69

- EVM, 69

- flow-based agile teams and, 64

- predictability, 66

- qualitative, 60

- results and, 61–70

- story points and, 66

- variability and, 61

Meetings. *See* Daily standups

Mentoring, 37, 82

Metrics. *See* Measurements

Microdeliverables, fixed-price, 77

Mindset. *See* Agile mindset

Minimum viable product (MVP), 23

Mini-waterfalls, 39

Mobbing, 39, 152

Multiproject management, 82

Multitasking

- burndowns and, 63

- productivity and, 44–45

Multiteam coordination, scaling and

MVP. *See* Minimum viable product

N

Non-agile approaches, 17

Norms, group, 50

Not-to-exceed time and materials approach, 78

O

OCM. *See* Organizational change management

Organization(s)

- evolving the, 84–86

- procurement-heavy, 83

- siloed, 47, 154

Organizational agility, roadblocks to, 74

Organizational bias, 152

Organizational change management, 71–74

- agile approaches and, 71–72

- drivers for, 73

- readiness for change and, 73–74

Organizational change management (OCM), 3, 153

Organizational culture, 75–77

- assessment, example of, 76

- assessment of, 74–75

- organizational structure versus, 77

- PMO and, 81

- safe environment and, 75

Organizational impediments, 35

Organizational learning, 82

Organizational silos. *See* Siloed organization

Organizational structure, 83

Out-of-scope items, 4

P

Pain points, troubleshooting and, 57–59

Paint-drip. *See* Broken comb

Pairing. *See* Pair work

Pair programming, 102, 153

Pair work, 39

Parking lot, problems and, 54

Part-time assignments, risk and, 45

Pay-as-you-go or pay-what-you-use model, 3

PDCA. *See* Plan-Do-Check-Act

Personas, 153

Personnel, development of, 82

“Phase gates,” 77

Pivot, 153

Plan-Do-Check-Act (PDCA), 153

Plan-driven approach, 153

Planning

 feedback and, 29

 iteration-based agile and, 55

 life cycles and, 20

 replanning and, 61

PMBOK Guide, 17, 38

PMO. *See* Project management office

Predictive approaches

 agile approach combined with, 27

 with agile components, 28

 measurements and, 60

Predictive component, agile approach with, 28

Predictive life cycle(s)

 characteristics of, 20–21

 continuum of life cycles and, 19

 defined, 153

Predictive rollout, following agile development, 26–27

Problems

 standups and, 54

 troubleshooting, 57–59

Problem solving, facilitation of, 39–40

Procurement

 business practices and, 79

 contracts and, 77–79

Procurement-heavy organizations, 83

Product, minimum viable, 23

Product backlog. *See also* Backlog refinement
 defined, 153

 initial, ranked for changes, 85

 preparation of, 52

 Scrum framework and, 31

Product backlog burnup chart, 68

Product delivery. *See* Deliveries

Productivity

 boosting, 39–40

 task switching and, 44–45

Product owner

 cross-functional teams and, 38

 defined, 153

 product roadmap and, 52

 role, agile team member, 41

 Scrum framework and, 31

 throughput and, 66

Product roadmap, 52

Progressive elaboration, 153. *See also* Backlog refinement

Progress tracking, 27. *See also* Kanban board

Project(s)

 inherent characteristics and, 18

 large, 15

Project charter, 49–50

Project factors, tailoring options and, 32

Project knowledge, vendors and, 83

Project leaders, stakeholders and, 75

Project life cycles. *See* Life cycle(s)

Project management, goal of, 29

Project Management Institute (PMI®), 1, 43

Project management office (PMO), 81–82

 defined, 153

 demonstrations and, 57

 invitation-oriented, 81

 multidisciplinary, 82

 value-driven, 81

Project manager(s)

 agile environment and

 defined, 38

 role of, 37

 servant leadership and, 38

Project risks, hybrid life cycle and, 29

Project task board

 cumulative flow diagram and, 70

 “walking the,” 53

 work in progress and, 25

Project vision, 49
Project work, 7
Proof of concept, 22
Prototyping, 15, 22

Q

Qualitative measures, 60
Quantitative risk analysis, 37

R

Rational unified process (RUP), 149
Reaction time, 66
Refactoring
 blending approaches and, 31
 defined, 153
Regulatory environments, 36
Relative estimation, 67
Remote pairing, 46
Requirements
 addressing all, 39
 culture and, 75
 feature burnup/burndown charts and, 67
 iterative exploration of, 15
 missing, 60
 predictive life cycles and, 20
 prototypes and, 22
 uncertainty and, 13, 14, 16, 22, 24
Response time, 64
Retrospectives, 27, 50–51
 defined, 153
 key times for, 51
 product knowledge and, 83
Return on investment (ROI), 30, 61
Reviews, demonstrations and, 55
Rework
 reduction of potential, 23
 risk of, 13, 14
Risk(s)
 customer-supplier relationship and, 77
 fixed-price increments and, 77
 high-uncertainty projects and, 7
 hybrid life cycle and, 29
 part-time assignments and, 45
 uncertainty, life cycle selection and, 13–16

Roadblocks, organizational agility and, 74
Roadmap, product, 52
ROI. *See* Return on investment
Role(s)
 agile teams and, 40–41
 project manager, 37
 temporary specialists and, 45
Rolling wave planning, defined, 153
RUP. *See* Rational unified process

S

SAFe®. *See* Scaled Agile Framework®
Safety, environment of, 75
SBE. *See* Specification by example
Scaled Agile Framework (SAFe®), 153
Scaling, 80
Schedule performance index (SPI), 69
Scope creep, 28
Scope items, in- and out-of, 4
Scrum
 collaboration and, 80
 defined, 153
 framework for, 31
Scrumban, 153
Scrum board, 154
Scrum Master
 defined, 154
Scrum framework and, 31
Scrum of Scrums, 154
Scrum team, 154
Self-management, 36
Self-managing teams, 39
Self-organizing team(s)
 case example, 43
 defined, 154
 financial institution example, 44
 project managers and, 37
 standups and, 54
Serial life cycle, 17. *See also* Predictive life cycle
Servant leader(s)
 characteristics of, 34
 chartering process and, 49, 50
 facilitation and, 35, 52
 organizational impediments and, 35

- project managers using, 38
- responsibilities of, 34, 36–37
- role of, 33

Servant leadership

- agile teams and, 39
- defined, 154
- project managers and, 38
- team empowerment and, 33–38

Service(s)

- delivery of, 35
- PMO and, 82

Service request manager, 154

Siloed organization

- cross-functional teams and, 47
- defined, 154

Single loop learning, 154

Skills, interpersonal versus technical, 36

SMEs. *See* Subject matter experts

Smoke testing

- defined, 154
- value delivery and, 56

Social contract. *See* Project charter

Social media, 2

Software development

- Agile Manifesto and, 8
- agile practices and, 2
- learning and, 61
- thought leaders in, 8

Software Extension to the PMBOK® Guide Fifth Edition, 17

Specialists, generalizing, 42

Specification by example (SBE), 154

SPI. *See* Schedule performance index

Spike(s)

- backlog refinement and, 52
- defined, 154
- value delivery and, 56

Sponsor, project completion and, 61

Sprint, 154

Sprint backlog, 154

Sprint planning

- defined, 154

Scrum framework and, 31

Stacey Complexity Model, 14, 15

Stakeholders

- education of, 37
- management of, 82
- project leaders and, 75

Standups. *See* Daily standups

“Start-where-you-are” approach, 13, 16

Status meetings, 54

Status reporting, traffic light, 60

Stories. *See also* User Story

- backlog refinement and, 52, 53
- finishing one at a time, 68
- reliable velocity and, 61

Story cards, 31

Story point

- burndown chart and, 62
- burnup chart and, 63
- completed, 63
- defined, 154
- iterations and, 61, 64
- measurement and, 66
- measuring, 66
- velocity and, 64

Strategy

- culture and, 75
- passion for a cause and, 75

Subject matter experts (SMEs), 43, 82

Suitability, filters for, 25

Suppliers, full-service, 79

Swarming, 39, 154

System-level testing, 56

T

Tailoring

- hybrid transition and, 30
- PMO and, 81
- premature or haphazard, 12
- project factors influencing, 32

Task board. *See also* Kanban board; Project task board

- “walking” the, 53

Task switching, productivity and, 44–45

TDD. *See* Test-Driven Development

- Team(s). *See also* Agile teams; Cross-functional team(s);
 - Self-organizing team(s)
 - accumulating work and, 70
 - business practices and, 79
 - chartering project and, 49–50
 - collocated, 39, 43, 44, 45
 - composition of, 38–47
 - coordination, multi-team, 80
 - core members of, 45
 - core writing, guide and, 1
 - delivery, 35
 - dispersed, 43, 44, 45
 - distributed, 43, 46
 - facilitator, role of, 41
 - self-managing, 39
 - Team augmentation contracting approach, 76
 - Team charter, 49–50
 - Team facilitator, role of, 41
 - Team leaders, 82
 - Team members, dedicated, 44–45
 - Team roles, agile, 40–41
 - Team structures, 43
 - Team values, 50
 - Team workspaces, 46
 - Technical debt, 154
 - Technical skills, 36
 - Technologies, disruptive, 2, 3
 - Temporary specialists, 45, 83
 - Test-Driven Development (TDD)
 - blending approaches and, 31
 - defined, 154
 - value delivery and, 56
 - Testing
 - acceptance, 82
 - at all levels, 56
 - automated, 31, 56
 - uncertainty and, 16
 - Thought processes. *See* Agile mindset
 - Throughput, 42
 - multitasking and, 44
 - product owner and, 66
 - standups and, 54
 - Time and materials approach
 - graduated, 78
 - not-to-exceed, 78
 - Timebox(es). *See also* Spike(s)
 - defined, 154
 - standups and, 53
 - use of, 12
 - Tradeoffs, 76
 - Traffic light status reporting, 60
 - Training, 82
 - Transition strategy, hybrid life cycles as, 30
 - Transparency
 - collaboration and, 79
 - delivering value and, 87
 - success and, 85
 - Troubleshooting, 57–59, 82
 - T-shaped, 42, 155
- U**
- Uncertainty. *See also* Change(s)
 - complexity and, 7, 13
 - exploration of, 16
 - medium- to low- degree of, 30
 - requirements and, 13, 14, 16, 22, 24
 - risk, life cycle selection and, 13–16
 - technical degree of, 14
 - Uncertainty and Complexity Model, 14
 - Unit testing, 56
 - Upfront estimation, 27
 - User Story
 - defined, 155
 - demonstrations and, 55
 - as microdeliverable, 77
 - User story mapping, 155
 - U.S. FDA approval process, 26
 - UX design, 155
- V**
- Value. *See also* Business value delivery; Deliverables
 - acceleration of, 30
 - contracting techniques and, 77
 - delivering, 16, 23, 56
 - intermediate, 29
 - learning and, 61–62
 - metrics and, 60
 - optimizing flow of, 38–39

Value stream, 155
Value stream mapping, 155
Variability, measures of, 61
Velocity
 defined, 64
 relative estimation and, 67
Vendors, project knowledge and, 83
Video conferencing, 46
Virtual workspaces, 46
Vision, project, 49
Visual tool. *See* Kanban board

W

Wasted work, 14
Waste reduction, 15
Waterfall life cycle, 17. *See also* Predictive life cycle
WIP. *See* Work in progress
Work
 accumulating, 70
 wasted, 14
Work assignment, 27
Working agreements, 50
Work in process, 31
Work in progress (WIP), 39
 cumulative flow diagram and, 70
 Kanban board and, 66
 task board and, 25
Workspaces, team, 46

X

XP. *See* eXtreme Programming
XP-inspired engineering practices, 31

